

JOB \_\_\_\_\_

TYPE \_\_\_\_\_

NOTES \_\_\_\_\_

APPROVALS \_\_\_\_\_

### FEATURES

- Die-cast copper aluminum with stainless steel fasteners
- 3000K color temperature
- Aimable 358° vertically, horizontal aiming controlled by installation mounting device

### CERTIFICATIONS



### SPECIFICATIONS

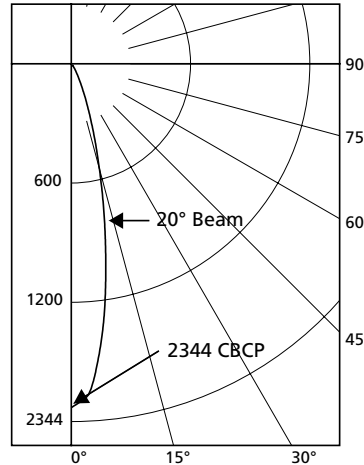
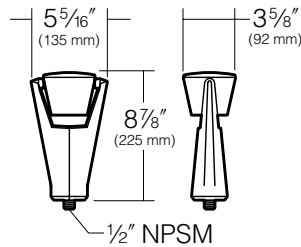

Voltage: 120    Watts: 6.84    Amps: 0.83  
 Lumens: 470    CBCP: 2344    Beam: 20°  
 CCT: 3000K    Efficacy: 69    Lm/W

### ORDERING CODE

Model	Fixture Options	Mounting Options
<b>ELL271BL</b> Black	<b>HL</b> <sup>1</sup> Hex Cell Louver for brightness control.	<b>EP17</b> Landscape Light Post Mount, 12V & 120V
<b>ELL271DB</b> Dark Bronze	<b>PL</b> <sup>1</sup> Prismatic Spread Lens softens lamp distribution. Best with spot.	<b>J-25N</b> Portable Spear Mount, 120V, Lowlighter only
<b>ELL271GR</b> Verde Green	<b>SL</b> <sup>1</sup> Linear Spread Lens creates oval beam pattern. Best with spot.	<b>JB1</b> <sup>2</sup> Architectural J-box, 12V & 120V
		<b>JBR-2</b> In-grade J-box (2) 1/2" NPT in bottom, 12V & 120V
		<b>JBR-3</b> In-grade J-box (2) 3/4" NPT in bottom, 12V & 120V
		<b>JBR-4</b> Composite in-grade J-box (2) 1/2" NPT in bottom, (4) NPT on sides @ 90°, 12V & 120V
		<b>JBR-5</b> Brass cover, composite in-grade J-box (2) 1/2" NPT in bottom, (4) NPT on sides @ 90°, 12V & 120V
		<b>JBR-21</b> In-grade J-box (2) 1/2" NPT in sides, (2) 1/2" NPT in bottom, 12V & 120V
		<b>JBR-24</b> In-grade J-box (4) 1/2" NPT in sides, (2) 1/2" NPT in bottom, 12V & 120V
		<b>JBR-30</b> Brass in-grade staked J-box, 12V & 120V
		<b>JBR-32</b> Brass in-grade staked J-box with cord, 120V
		<b>SM18</b> <sup>3</sup> Stanchion Mount, 12V & 120V <sup>3</sup>
		<b>J-27N</b> Surface Mount, 120V, Lowlighter only
		<b>JWBR</b> <sup>3</sup> Brass Architectural Wall Mount, 120V, Lowlighter only <sup>4</sup>
		<b>JW</b> Architectural Wall Mount, 120V, Lowlighter only

<sup>1</sup> Inserts behind lens.

<sup>2</sup> Specify finish, **BL** - Black, **DB** - Dark Bronze, **GR** - Verde Green.

<sup>3</sup> Specify finish, **NB** - Natural Brass, **VG** - Verde Green Patina.

Kim Lighting reserves the right to change specifications without notice.

## LUMINAIRE PERFORMANCE

Nominal Lumen Package	Center Beam Candle Power	Watts	Lumens Per Watt
470	2344	6.84	69

## SPECIFICATIONS

### Lamp Housing:

- Die-cast low copper aluminum, stainless steel fasteners and stainless steel set screw lock for aiming pivot.

### Aiming:

Aimable 358° vertically, horizontal aiming controlled by installation on mounting device.

### Ravenna Yoke:

- Die-cast low copper aluminum, stainless steel fasteners and 1/2" NPSM brass nipple mount.

### Lens:

- Tempered glass, 1/8" nominal thickness.

### Gasketing:

- Silicone gaskets used throughout.

### Transformer:

- Remote low voltage transformer required.

### Wiring:

- No. 18AWM rated 105°C.

### Driver/Optical System:

- 3 LED emitters configured in a triangle array comprised together as a module. Each LED is encapsulated under a precision optical prism to produce a narrow flood pattern. The -40c driver is within the module and operates on 12V AC or DC current, 10 watt, 0.83 amp.

### Finish:

- Fade and abrasion resistant, electrostatically applied, thermally cured, triglycidal isocyanurate (TGIC) polyester powder coat.
- Standard colors include (BL) Black, (DB) Dark Bronze, (GT) Graphite, (PS) Platinum Silver, (LG) Light Gray, (TT) Titanium, (WH) White, and (CC) Custom Color (Include RAL#).

### Certifications and Listings:

- UL 1598 Standard for wet locations for Luminaires.
- UL 8750 Standard for Safety for Light Emitting Diode (LED) Equipment for use in Lighting Products.

### Caution:

- Fixtures must be grounded in accordance with national, state and/or local electrical codes, Failure to do so may result in serious personal injury.



### Warranty:

- For full warranty see <http://www.hubbellighting.com/resources/warranty>

Kim Lighting reserves the right to change specifications without notice.

## OPTIONS

### Fixture Options:

- Hex Cell Louver:** Constructed of hex cell aluminum louvers providing 45° cutoff, mounted in a circular frame, finished in baked high-heat flat black. Can be used in combination with colored lenses. Inserts behind lens. 
- Prismatic Lens:** Softens lamp distribution and flattens beam spread. Best with flood lamps. Replaces standard lens. Cannot be used in combination with HL louver. 
- Spread Lens:** Creates an oval beam pattern, more narrow in one beam axis. Best with spot lamps. Replaces standard lens. Cannot be used in combination with HL louver. 

### Mounting Options:

- Landscape Light Post:** PVC fixture molded in black with 1/2" NPT mount is corrosion free and UV resistant. Replaces EMT, conduit connectors and weatherproof boxes. 100% shatter resistant against denting and cracking. Angled bottom to eliminate cable congestion. 17 1/2" post length

**Caution:** The Ravenna Highlighter tray may be too heavy for the EP17. Any slight impact could damage the cap.

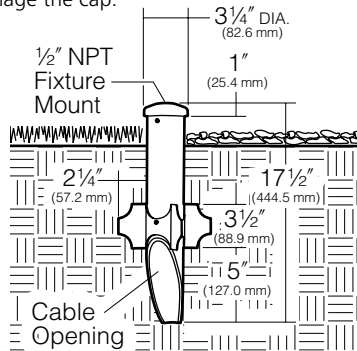

### Architectural Junction Box

- Die-cast aluminum with 1/2" NPSM fixture mount. Internal set screw provided for locking position. Two K" NPSM in bottom, 17 cu in. internal volume. Super TGIC powder coat paint over clear anodizing and titanated zirconium conversion coating.

### Application Notes

- Elevates Accent Lights above ground cover to prevent foliage from blocking the light.
- Elevates Path Lights above ground cover to achieve a greater light throw.

**CAUTION:** Junction box must be installed high enough to avoid contact with soil or standing water.

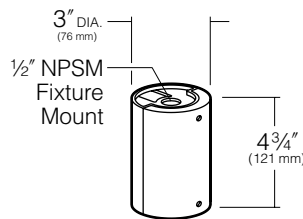

### Brass In-grade Architectural Junction Box

- Die-cast brass with K" NPSM fixture mount and die-cast cover. Internal set screw provided for locking position. 18 cu in. internal volume.

JBR-2 (2) 1/2" NPT in bottom

JBR-3 (2) L" NPT in bottom

JBR-21 (2) 1/2" NPT in sides, (2) 1/2" NPT in bottom

JBR-24 (4) 1/2" NPT in sides, (2) 1/2" NPT in bottom

All side taps provided with plugs.

### 25 Year Limited Warranty:

Solid brass junction boxes are warranted for 25 years, from date of sale, against manufacturing defects and failure due to corrosion.

### Application Notes

- Creates a flush-mounted appearance.
- May be cast in concrete for increased stability.

**CAUTION:** Fixture stem and swivel must not contact soil or standing water. Provide drainage away from junction box.

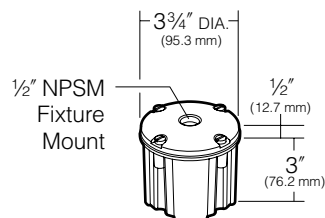

### Composite In-Grade Architectural Junction Box

Composite box with 1/2" NPSM fixture mount and composite cover. 19 cu in. internal volume.

JBR-4 (2) L" NPT knockouts in bottom.

(4) L" NPT knockouts on sides.

JBR-5 Same as above but with brass cover.

**CAUTION:** Fixture stem and swivel must not contact soil or standing water. Provide drainage away from J-Box.

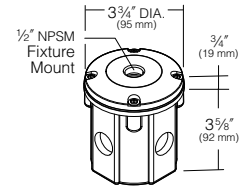

### Stanchion Mount

3" O.D. by .188" wall cast aluminum with 1/2" NPSM fixture mount and hand hole with flush cover. Internal set screw fixture lock accessible through hand hole. Internal ground lug supplied with installed lead. Super TGIC powder coat paint over clear anodizing and titanated zirconium conversion coating.

