

Linear

LiNi BLADE-S 007

Fixture Guide

KKDÖ

Indoor | Surface | Tight pitch output up to 690lm/m (210lm/ft)

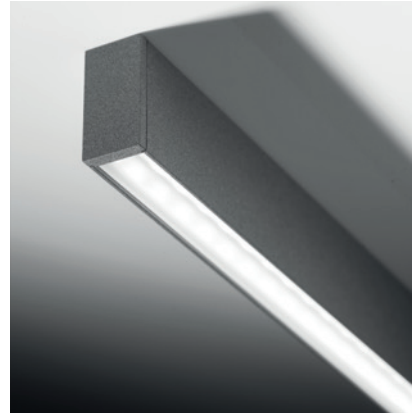

Key applications

- ✓ Ceiling
- ✓ Cove lighting
- ✓ Downlighting
- ✓ Interior
- ✓ Retail display
- ✓ Under cabinet
- ✓ Wall grazing

Key features

- ✓ Custom lengths
- ✓ Decorative
- ✓ Diffusion: Homogenous
- ✓ Direct view
- ✓ Extensive CCT range
- ✓ Form factor: Small
- ✓ IP40
- ✓ Lens options: 15°, 46°
- ✓ Output low

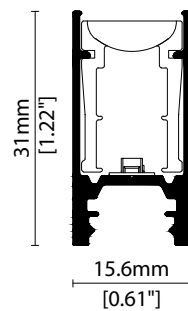

MOUNTING METHODS



KKCP-10 Concealed clip



KKSU-06 Suspension mounting kit

Linear

LiNi BLADE-S 007

Specification sheet



Dimension	H31/W15.6/L103.3-2020mm (H1.22/W0.61/L4.07-79.53in)
PCB increment	41.7mm increment/2000mm max (1.64in increment/78.74in max)
LED pitch	6.9mm - 144LED/m (0.27in - 44LED/ft)
Chip	s/e-line Toyoda Gosei k-line Toyoda Gosei or Equivalent
Beam angle	110° (Diffused Cover)/15° (KKLN-01D Lens)/46° (KKLN-01U Lens)
Colours	s/e-line 1900K/2100K/2300K/2500K/2700K/3000K/3500K/4000K/5000K Single colours: Red/Green/Blue/Orange/Amber k-line 1900K/2100K/2300K/2500K/2700K/3000K/3500K/4000K/5000K
Bin/Step	s-line 2-step MacAdam ellipse e/k-line 3-step MacAdam ellipse
CRI	≥ 90
Lifetime	50,000 hours @ 25°C (50,000 hours @ 77°F)
Operating temp	T _a = -25 to 41°C (T _c max = 58.9°C) T _a = -13 to 105.8°F (T _c max = 138°F)
IP rating	IP40
Finish	Matt White/Matt Black/Matt Gray/Matt Silver/Bronze Powder coating
Cover/lens	Diffused/15° lens/46° lens
Mounting	Surface mounting via concealed clips
Power feed	Hardwire tails
Control	0-10V/1-10V/DMX/DALI

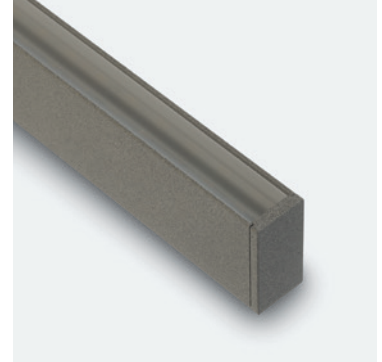

LED Grading Key

Exclusive Grade

- s-line***
2-step CCT range
- e-line***
3-step CCT range

*KKDC tuned CCT range

Base Grade

- k-line**
3-step commercial range
Energy Star CCTs

PERFORMANCE DATA @ 3000K

Power consumption	Supply voltage	Supply current
10.9W/m (3.32W/ft)	24V DC	0.45A/m (0.138A/ft)

Colour Rendering Index (CRI)

	R1	R2	R3	R4	R5	R6	R7	R8	R9	R10	R11	R12	R13	R14
k-line	94	97	98	93	93	96	92	83	60	93	94	82	95	99

	15° (KKLN-01D)	46° (KKLN-01U)	Diffused Cover	CRI	R9	Rf	Rg
s/e-line	470lm/m (140lm/ft) 42.8lm/W	690lm/m (210lm/ft) 63.3lm/w	260lm/m (80.2lm/ft) 23.9lm/W	93	63	-	-
k-line	460lm/m (140lm/ft) 42.2lm/W	670lm/m (204lm/ft) 61.5lm/W	260lm/m (79lm/ft) 23.5lm/W	92	60	-	-

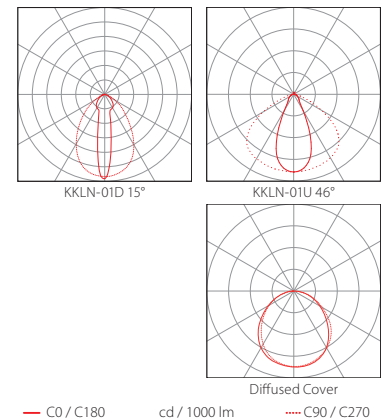
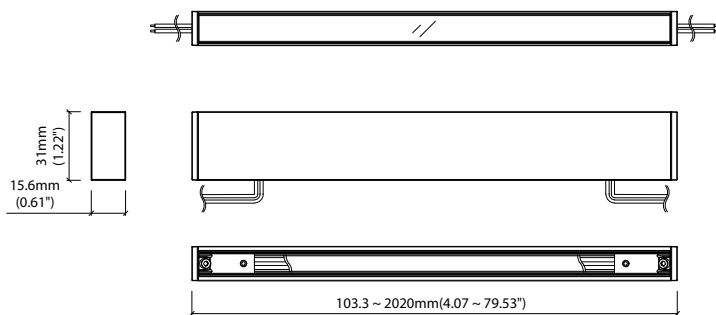

Data derived from independent UKAS/IESNA LM-79-08 accredited testing of production samples.

LiNi BLADE-S 007

Code Table



FIXTURE

Model	Finish	Cover/Lens ¹	Grade ²	LED	Colour (CCT)	Length Availability ³	IP	Cable Length	Power Feed ⁴	Input										
LiNi BLADE-S	BS	Matt White Paint	MW	Diffused	C	s	s	007	1900K	19	m	103.3-2020mm 41.7mm increments	IP40	40	300mm/ 11.81"	0300	Single no sheath tail	S00X	DC 24V	g
		Matt Silver Paint	MS	KKLN-01D 15°	S	e	e	2100K	21											
		Matt Grey Paint	MG	KKLN-01U 46°	R	k	k	2300K	23											
		Matt Black Paint	MB				2500K	25												
		Bronze Paint	BP				2700K	27												
							3000K	30												
							3500K	35												
							4000K	40												
							5000K	50												
							RED	RED	s-only											
							GREEN	GRN												
							BLUE	BLU												
							ORANGE	ORN												
					AMBER	AMB														

¹ Refer to **Cover/Lens Options** on **Options** pages

² Refer to **LED Grading Key** on **Specification sheet** page

³ Refer to **Length Availability List** or enter total run length instead of length code

⁴ Refer to **Power Feed Options** on **Options** pages

⁵ Transparent suspension wire

Code Example:

BS	-	MW	-	C	-	s	-	007	-	35	-	m	-	520	-	40	-	0300	-	D00X	-	g
LiNi BLADE-S		Matt White Paint		Diffused		s		007		3500K		520.3mm		IP40		300mm/11.81"		0300		Double no sheath tail		DC 24V

ACCESSORIES

Mounting Accessories

KKCP-10	Concealed Clip
KKSW-06	Suspension Mounting Kit

* Refer to **Mounting accessories** on **Accessories** pages

Connection Accessories

KKCN-01	2 PIN male & female 50mm (1.97in) pair
KKCN-03	2 PIN male & female 300mm (11.81in) pair
KKCN-06	2 PIN 300mm (11.81in) extension lead

* Refer to **Power feed** on **Accessories** pages

PSU/Driver

0-10V/1-10V/DALI/DMX

* Refer to **Driver/PSU Options** page for details or provide requirement and KKDC to offer the suitable option

LED ENGINE VARIANTS (LED STRIP TYPE)

Colour	Output	LED	Lumen/m	Lumen/ft	W/m	W/ft	Spec Doc	Length	Increment
Single CCT	Low	352	250	78.2	5.5	1.67	LiNi BLADE-S 352	103.3-2020mm (4.07-79.53in)	83.3mm (3.28in)
	Mid	504	580	117	12.5	3.81	LiNi BLADE-S 504	120-2020mm (4.72-79.53in)	100mm (3.94in)
	Mid	508	820	250	17.5	5.33	LiNi BLADE-S 508	91.4-2020mm (3.60-79.53in)	71.4mm (2.81in)
	Low	007	470	140	10.9	3.32	LiNi BLADE-S 007	103.3-2020mm (4.07-79.53in)	41.7mm (1.64in)
Warm Dim/Dynamic White	Low	207	450	136	11	3.35	LiNi BLADE-S 207	103.3-2020mm (4.07-79.53in)	83.3mm (3.28in)
	Mid	208	720	220	15.6	4.75	LiNi BLADE-S 208	186.7-2020mm (7.35-79.53in)	166.7mm (6.56in)
RGB		501	Red 71 Green 153 Blue 25 RGB 221	Red 22 Green 47 Blue 8 RGB 67	15.6	4.75	LiNi BLADE-S RGB	103.3-2020mm (4.07-79.53in)	83.3mm (3.28in)

* Performance data: s/e-line, KKLN-01 15° lens, 3000K

LiNi BLADE-S 007

Length Availability List



Length Code		Fixture Length ¹		LED Strip ²		End Cap Dimension ³		Wattage (W)	Output (lm)	
Metric	Imperial(US)	Metric	Imperial(US)	Metric	Imperial(US)	Metric	Imperial(US)		3000K (Test Data)	Range Data
m0062	i0002	62mm	2.43in	42mm	1.64in	5mm	0.20in	0.45	29	7-30
m0103	i0004	103mm	4.07in	83mm	3.28in	5mm	0.20in	0.91	57	14-60
m0145	i0006	145mm	5.71in	125mm	4.92in	5mm	0.20in	1.36	86	21-90
m0187	i0007	187mm	7.35in	167mm	6.56in	5mm	0.20in	1.82	115	27-120
m0228	i0009	228mm	8.99in	208mm	8.20in	5mm	0.20in	2.27	144	34-149
m0270	i0011	270mm	10.63in	250mm	9.84in	5mm	0.20in	2.73	172	41-179
m0312	i0012	312mm	12.27in	292mm	11.48in	5mm	0.20in	3.18	201	48-209
m0353	i0014	353mm	13.91in	333mm	13.12in	5mm	0.20in	3.63	230	55-239
m0395	i0016	395mm	15.55in	375mm	14.76in	5mm	0.20in	4.09	259	62-269
m0437	i0017	437mm	17.19in	417mm	16.41in	5mm	0.20in	4.54	287	69-299
m0478	i0019	478mm	18.83in	458mm	18.05in	5mm	0.20in	5.00	316	76-329
m0520	i0020	520mm	20.47in	500mm	19.69in	5mm	0.20in	5.45	345	82-359
m0562	i0022	562mm	22.11in	542mm	21.33in	5mm	0.20in	5.90	374	89-389
m0603	i0024	603mm	23.76in	583mm	22.97in	5mm	0.20in	6.36	402	96-419
m0645	i0025	645mm	25.40in	625mm	24.61in	5mm	0.20in	6.81	431	103-448
m0687	i0027	687mm	27.04in	667mm	26.25in	5mm	0.20in	7.27	460	110-478
m0728	i0029	728mm	28.68in	708mm	27.89in	5mm	0.20in	7.72	489	117-508
m0770	i0030	770mm	30.32in	750mm	29.53in	5mm	0.20in	8.18	517	124-538
m0812	i0032	812mm	31.96in	792mm	31.17in	5mm	0.20in	8.63	546	130-568
m0853	i0034	853mm	33.60in	833mm	32.81in	5mm	0.20in	9.08	575	137-598
m0895	i0035	895mm	35.24in	875mm	34.45in	5mm	0.20in	9.54	604	144-628
m0937	i0037	937mm	36.88in	917mm	36.09in	5mm	0.20in	9.99	632	151-658
m0978	i0039	978mm	38.52in	958mm	37.73in	5mm	0.20in	10.45	661	158-688
m1020	i0040	1020mm	40.16in	1000mm	39.37in	5mm	0.20in	10.90	690	165-718
m1062	i0042	1062mm	41.80in	1042mm	41.01in	5mm	0.20in	11.35	719	172-747
m1103	i0043	1103mm	43.44in	1083mm	42.65in	5mm	0.20in	11.81	747	179-777
m1145	i0045	1145mm	45.08in	1125mm	44.29in	5mm	0.20in	12.26	776	185-807
m1187	i0047	1187mm	46.72in	1167mm	45.94in	5mm	0.20in	12.72	805	192-837
m1228	i0048	1228mm	48.36in	1208mm	47.58in	5mm	0.20in	13.17	834	199-867
m1270	i0050	1270mm	50.00in	1250mm	49.22in	5mm	0.20in	13.63	862	206-897
m1312	i0052	1312mm	51.64in	1292mm	50.86in	5mm	0.20in	14.08	891	213-927
m1353	i0053	1353mm	53.29in	1333mm	52.50in	5mm	0.20in	14.53	920	220-957
m1395	i0055	1395mm	54.93in	1375mm	54.14in	5mm	0.20in	14.99	949	227-987
m1437	i0057	1437mm	56.57in	1417mm	55.78in	5mm	0.20in	15.44	977	233-1017
m1478	i0058	1478mm	58.21in	1458mm	57.42in	5mm	0.20in	15.90	1006	240-1046
m1520	i0060	1520mm	59.85in	1500mm	59.06in	5mm	0.20in	16.35	1035	247-1076
m1562	i0061	1562mm	61.49in	1542mm	60.70in	5mm	0.20in	16.80	1064	254-1106
m1603	i0063	1603mm	63.13in	1583mm	62.34in	5mm	0.20in	17.26	1092	261-1136
m1645	i0065	1645mm	64.77in	1625mm	63.98in	5mm	0.20in	17.71	1121	268-1166
m1687	i0066	1687mm	66.41in	1667mm	65.62in	5mm	0.20in	18.17	1150	275-1196
m1728	i0068	1728mm	68.05in	1708mm	67.26in	5mm	0.20in	18.62	1179	282-1226
m1770	i0070	1770mm	69.69in	1750mm	68.90in	5mm	0.20in	19.08	1207	288-1256
m1812	i0071	1812mm	71.33in	1792mm	70.54in	5mm	0.20in	19.53	1236	295-1286

LiNi BLADE-S 007

Length Availability List



Length Code		Fixture Length ¹		LED Strip ²		End Cap Dimension ³		Wattage (W)	Output (lm)	
Metric	Imperial(US)	Metric	Imperial(US)	Metric	Imperial(US)	Metric	Imperial(US)		3000K (Test Data)	Range Data
m1853	i0073	1853mm	72.97in	1833mm	72.18in	5mm	0.20in	19.98	1265	302-1316
m1895	i0075	1895mm	74.61in	1875mm	73.82in	5mm	0.20in	20.44	1294	309-1345
m1937	i0076	1937mm	76.25in	1917mm	75.47in	5mm	0.20in	20.89	1322	316-1375
m1978	i0078	1978mm	77.89in	1958mm	77.11in	5mm	0.20in	21.35	1351	323-1405
m2020	i0080	2020mm	79.53in	2000mm	78.75in	5mm	0.20in	21.80	1380	330-1435

¹ Actual total overall length of light fixture (LED strip + end caps + void/wire hole)

² Actual length of PCB strip

³ Actual length of 2x end caps

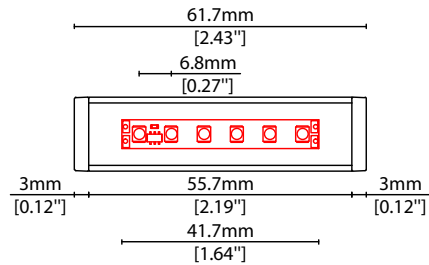

COVER/LENS OPTIONS

* Options are an integral part of the fixture ordering codes. Please refer to **Code Table** pages.



C Diffused Cover
Polycarbonate finish
W15.6/H31mm (W0.61/H1.22")

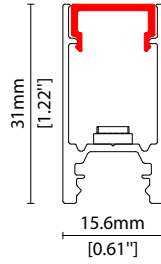

S KKLN-01D 15° lens
15° beam linear lens,
co-extruded PMMA
W15.6/H31mm (W0.61/H1.22")

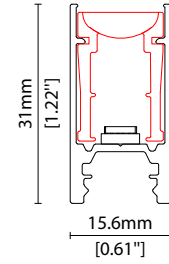

R KKLN-01U 46° lens
46° beam linear lens,
co-extruded PMMA
W15.6/H31mm (W0.61/H1.22")

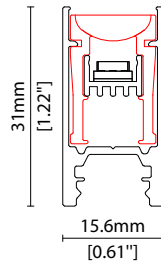

POWER FEED OPTIONS

* Options are an integral part of the fixture ordering codes. Please refer to **Code Table** pages.

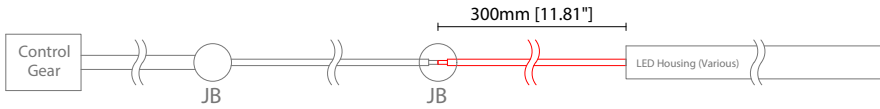
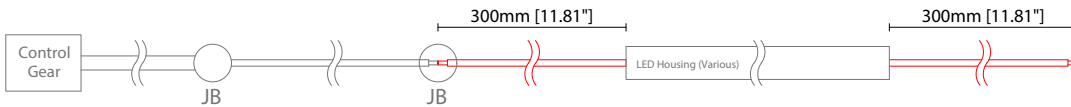
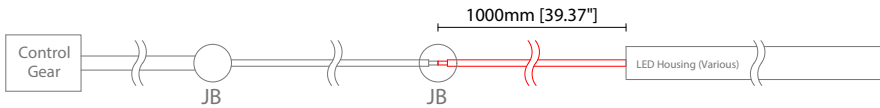
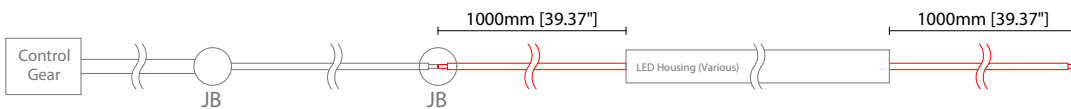
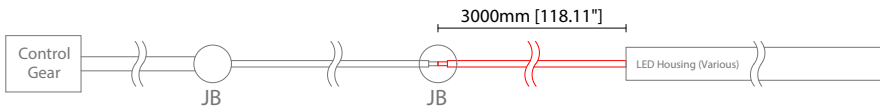
0300 S00X 300mm (11.81") Single no sheath tail

0300 D00X 300mm (11.81") Double no sheath tail

1000 S00X 1000mm (39.37") Single no sheath tail

1000 D00X 1000mm (39.37") Double no sheath tail

3000 S00H 3000mm (118.11") Suspension single no sheath tail

Key

Control Gear Power supply, sub-controllers & control systems
JB Junction box / cable connection

MOUNTING ACCESSORIES

Note: Accessories are to be ordered separately with corresponding code shown below.



KKCP-10

Concealed clip
(allow 2 per metre/40in)
S/Steel finish
L20/W15.6/H31mm
(L0.79/W0.61/H1.22")

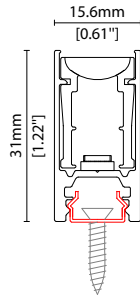

KKSU-06

Suspension mounting kit
(allow 2 per metre/40in)
S/Steel finish
L14.9/W16/H3031mm
(L0.59/W0.63/H119.33")

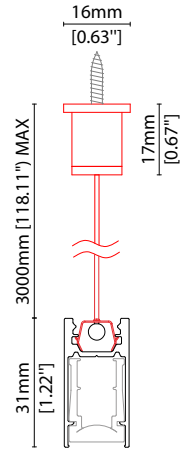

POWER FEED

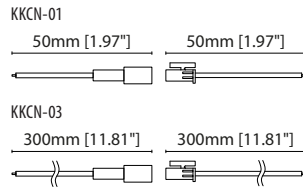
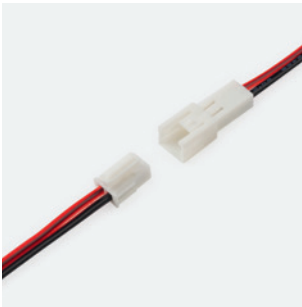

KKCN-01 50mm (1.97in) pair
KKCN-03 300mm (11.81in) pair
2 PIN male + female connector set



KKCN-06

2 PIN 300mm (11.81in) extension lead

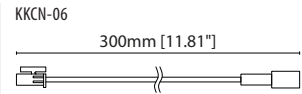

KKDC CONTROL



IP20
Plastic housing
L170/W59/H29mm
(L6.69/W2.32/H1.14in)

KKDM-06 1-10V
visDIM dimmable sub-controller
(4 x 8A max @ 12-36V)



IP20
Plastic housing
L170/W53.4/H28mm
(L6.69/W2.10/H1.10in)

KKSC-05 DMX
visDIM dimmable sub-controller
(4 x 5A max @ 12-36V)

Linear

LiNi BLADE-S 007

Accessories

KKDÖ

KKDC CONTROL (CONTINUED)



IP20
Plastic housing
L170/W59/H29mm
(L6.69/W2.32/H1.14in)

KKDL-02 DALI

visDIM dimmable sub-controller
(4 x 8A max @ 12-36V)



IP20
Plastic housing
L166/W53.4/H23mm
(L6.54/W2.10/H0.91in)

KKDL-03 DALI

visDIM dimmable sub-controller
(4 x 5A max @ 12-36V)

AVAILABLE PSU OPTIONS

Control Mode	PSU (Order Code)	Input Voltage AC	Output Voltage DC	Rated Output Current	Rated Power	Dim %	IP Rating
Switched	CEN-60-24	90-295V	24V	2.5A	60W	-	IP67
	HLG-60H-24	90-305V	24V	2.5A	60W	-	IP67
	HLG-100H-24	90-305V	24V	4.0A	100W	-	IP67
	HLG-150H-24	90-305V	24V	6.3A	150W	-	IP67
	HLG-240H-24	90-305V	24V	10A	240W	-	IP67
0-10V (1-10V)	PWM-40-24	90-305V	24V	1.67A	40W	100-0.15 (100-10)	IP67
	PWM-60-24	90-305V	24V	2.5A	60W	100-0.15 (100-10)	IP67
	PWM-90-24	90-305V	24V	3.67A	90W	100-0.15 (100-10)	IP67
	PWM-120-24	90-305V	24V	5.0A	120W	100-0.15 (100-10)	IP67
DALI	LIN100A1	120-277V	24V	1A per channel	100W	100-0.1	IP66/IP40
DMX RGB	LIN100A1	120-277V	24V	1.33A per channel	100W	100-0.1	IP66/IP40
DMX RGBW	LIN100A1	120-277A	24V	1A per channel	100W	100-0.1	IP66/IP40

Flicker Free Options - Combination of PSU+ sub-controller

Control Mode	PSU (Order Code)	Sub-controller (Order Code)	Input Voltage AC	Output Voltage DC	Rated Output Current	Rated Power	Dim %	IP Rating PSU/ Sub-controller
0-10V or 1-10V	CEN-60-24	KKDM-06	90-295V	24V	2.5A	60W	100-0.9	IP67/IP20
	HLG-60H-24	KKDM-06	90-295V	24V	2.5A	60W	100-0.9	IP67/IP20
	HLG-100H-24	KKDM-06	90-295V	24V	4.0A	100W	100-0.9	IP67/IP20
	HLG-150H-24	KKDM-06	90-295V	24V	6.3A	150W	100-0.9	IP67/IP20
	HLG-240H-24	KKDM-06	90-295V	24V	10.0A	240W	100-0.9	IP67/IP20
DALI	CEN-60-24	KKDL-02/03	90-295V	24V	2.5A	60W	100-0.1	IP67/IP20
	HLG-60H-24	KKDL-02/03	90-305V	24V	2.5A	60W	100-0.1	IP67/IP20
	HLG-100H-24	KKDL-02/03	90-305V	24V	4.0A	100W	100-0.1	IP67/IP20
	HLG-150H-24	KKDL-02/03	90-305V	24V	6.3A	150W	100-0.1	IP67/IP20
	HLG-240H-24	KKDL-02/03	90-305V	24V	10.0A	240W	100-0.1	IP67/IP20
DMX RGB	CEN-60-24	KKSC-05	90-295V	24V	2.5A	60W	100-0.9	IP67/IP20
	HLG-60H-24	KKSC-05	90-305V	24V	2.5A	60W	100-0.9	IP67/IP20
	HLG-100H-24	KKSC-05	90-305V	24V	4A	100W	100-0.9	IP67/IP20
	HLG-150H-24	KKSC-05	90-305V	24V	6.3A	150W	100-0.9	IP67/IP20
	HLG-240H-24	KKSC-05	90-305V	24V	10.0A	240W	100-0.9	IP67/IP20

¹ The items shown above cover the most frequently used specification but does not exhaust the possible options

² PSU and/or driver can be chosen from the table, or KKDC may recommend the best option upon receipt of the controls requirement and installation environment

³ Electrical shop drawing will include detailed information of PSU and relevant control drivers

⁴ Cut sheets are available on the controls section of www.kkdc.lighting or upon request