

Linear

LiNi BLADE-S RGB Fixture Guide

KKDÖ

Indoor | Surface | RGB output

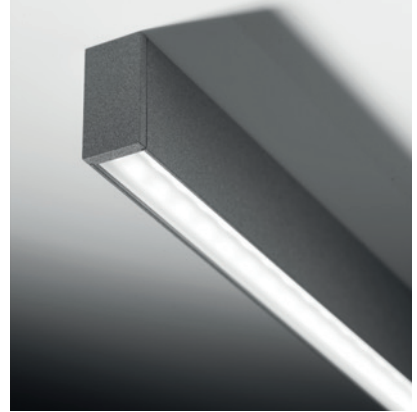
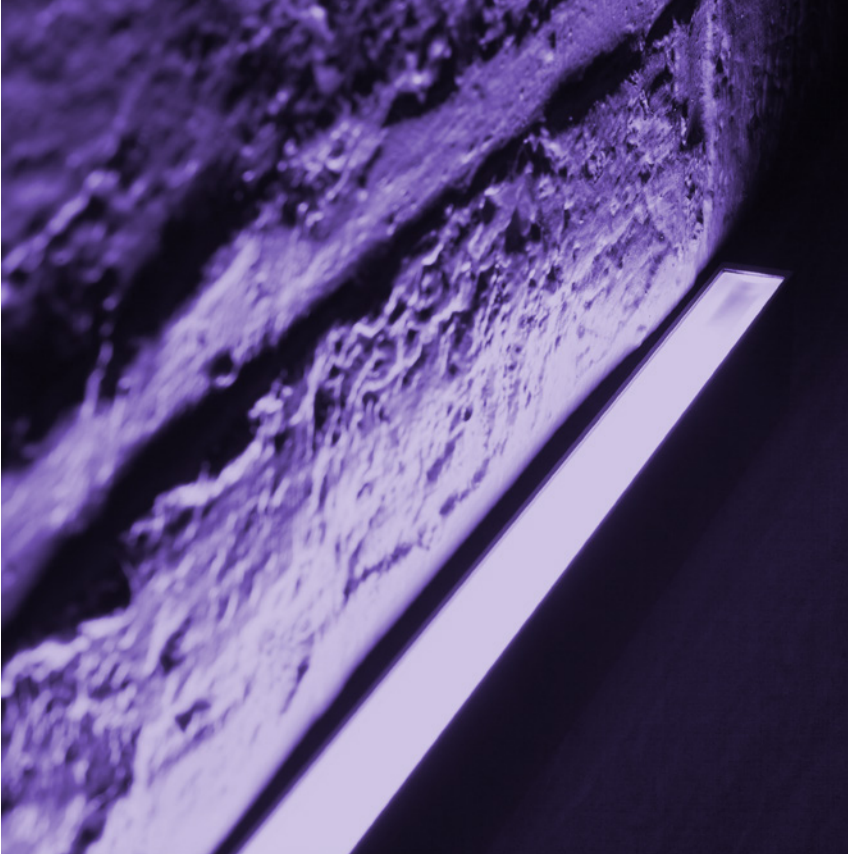

Key applications

- ✓ Ceiling
- ✓ Cove lighting
- ✓ Downlighting
- ✓ Interior
- ✓ Retail display
- ✓ Special effect
- ✓ Under cabinet
- ✓ Wall grazing

Key features

- ✓ Custom lengths
- ✓ Decorative
- ✓ Diffusion: Homogenous
- ✓ Direct view
- ✓ Form factor: Small
- ✓ IP40
- ✓ Lens options: 15°, 46°
- ✓ RGB

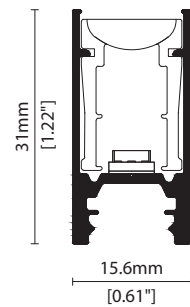

MOUNTING METHODS



KKCP-10 Concealed clip



KKSU-06 Suspension mounting kit

Linear

LiNi BLADE-S RGB

Specification sheet



Dimension	H31/W15.6/L186.7-2020mm (H1.22/W0.61/L7.35-79.53in)
PCB increment	83.3mm increment/2000mm max (3.28in increment/78.74in max)
LED pitch	13.9mm - 72LED/m (0.55in - 21.95LED/ft)
Chip	Red TEKCORE/Green EPILEDS/Blue 3E
Beam angle	110° (Diffused Cover)/15° (KKLN-01D Lens)/46° (KKLN-01U Lens)
Colours	Red 620-625nm/Blue 455-460nm/Green 520-525nm
Bin/Step	5nm tolerance
CRI	N/A
Lifetime	35,000 hours @ 25°C (35,000 hours @ 77°F)
Operating temp	T _a = -25 to 44°C (T _c max = 68.3°C) T _a = -13 to 111.2°F (T _c max = 154.9°F)
IP rating	IP40
Finish	Matt White/Matt Black/Matt Gray/Matt Silver/Bronze Powder coating
Cover/lens	Diffused/15° lens/46° lens
Mounting	Surface mounting via concealed clips
Power feed	Hardwire tails
Control	DMX/DALI

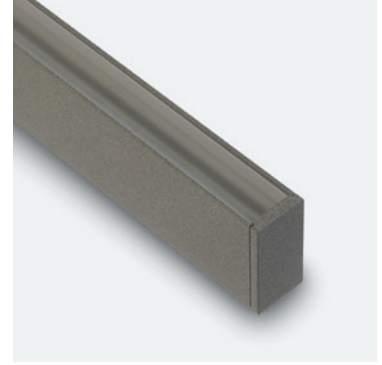

PERFORMANCE DATA

Power consumption	Supply voltage	Supply current
15.6W/m (4.75W/ft)	24V DC	0.65A/m (0.20A/ft)

15° (KKLN-01D)

Red: 71lm/m (22lm/ft)
Green: 153lm/m (47lm/ft)
Blue: 25lm/m (8lm/ft)
RGB: 221lm/m (67lm/ft)

46° (KKLN-01U)

Red: 105lm/m (32lm/ft)
Green: 225m/m (69lm/ft)
Blue: 37lm/m (11lm/ft)
RGB: 325lm/m (99lm/ft)

Diffused Cover

Red: 38lm/m (12lm/ft)
Green: 83lm/m (25lm/ft)
Blue: 14lm/m (4lm/ft)
RGB: 120lm/m (37lm/ft)

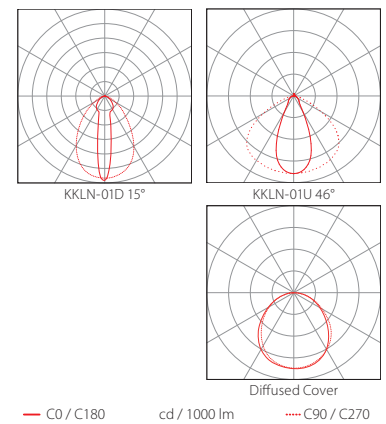
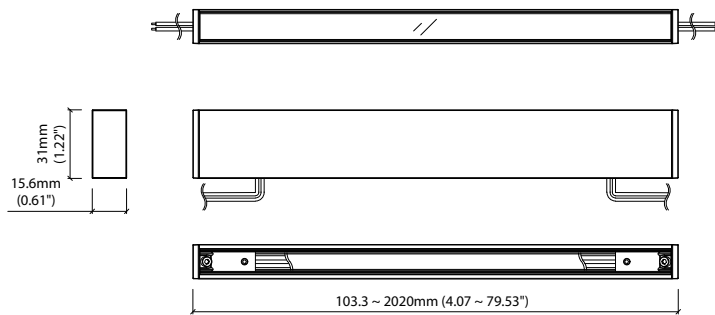

Data derived from production samples tested to UKAS/IESNA LM-79-08 standards.

See KKDC website for product document updates.

www.kkdc.lighting

LiNiBLADE-SRGRBS-02.02EN-20220808

Linear

LiNi BLADE-S RGB

Code Table



FIXTURE

Model	Finish	Cover/Lens ¹	Grade	LED	Colour (CCT)	Length Availability ²	IP	Cable Length	Power Feed ³	Input									
LiNi BLADE-S	BS	Matt White Paint	MW	Diffused	C	s	501	RGB	RGB	m	103.3-2020mm 83.3mm increments	IP40	40	300mm/ 11.81"	0300	Single no sheath tail	S00X	DC 24V	g
		Matt Silver Paint	MS	KKLN-01D 15°	S														
		Matt Grey Paint	MG	KKLN-01U 46°	R	i	4.07-79.53in 3.28in increments	1000mm/ 39.37"	1000					Double no sheath tail	D00X				
		Matt Black Paint	MB					3000mm/ 118.11"	3000					Suspension single no sheath tail ⁴	S00H				
		Bronze Paint	BP				(Specify length code OR total run length)												

¹ Refer to **Cover/Lens Options** on **Options** pages

² Refer to **Length Availability List** or enter total run length instead of length code

³ Refer to **Power Feed Options** on **Options** pages

⁴ Transparent suspension wire

Code Example:

BS	-	MW	-	C	-	s	-	501	-	RGB	-	m	-	520	-	40	-	0300	-	D00X	-	g
LiNi BLADE-S		Matt white paint		Diffused				501		RGB		519.8mm		IP40		300mm/11.81"		Double no sheath tail		DC 24V		

ACCESSORIES

Mounting Accessories

KKCP-10	Concealed Clip
KKSW-06	Suspension Mounting Kit

* Refer to **Mounting accessories** on **Accessories** pages

Connection Accessories

KKCN-07	4 PIN RGB male & female 50mm (1.97in) pair
KKCN-09	4 PIN RGB male & female 300mm (11.81in) pair
KKCN-11	4 PIN RGB 300mm (11.81in) extension lead

* Refer to **Power feed** on **Accessories** pages

PSU/Driver

DALI/DMX

* Refer to **Driver/PSU Options** page for details or provide requirement and KKDC to offer the suitable option

LED ENGINE VARIANTS (LED STRIP TYPE)

Colour	Output	LED	Lumen/m	Lumen/ft	W/m	W/ft	Spec Doc	Length	Increment
Single CCT	Low	352	250	78.2	5.5	1.67	LiNi BLADE-S 352	103.3-2020mm (4.07-79.53in)	83.3mm (3.28in)
	Mid	504	580	117	12.5	3.81	LiNi BLADE-S 504	120-2020mm (4.72-79.53in)	100mm (3.94in)
	Mid	508	820	250	17.5	5.33	LiNi BLADE-S 508	91.4-2020mm (3.60-79.53in)	71.4mm (2.81in)
	Low	007	470	140	10.9	3.32	LiNi BLADE-S 007	103.3-2020mm (4.07-79.53in)	41.7mm (1.64in)
Warm Dim/Dynamic White	Low	207	450	136	11	3.35	LiNi BLADE-S 207	103.3-2020mm (4.07-79.53in)	83.3mm (3.28in)
	Mid	208	720	220	15.6	4.75	LiNi BLADE-S 208	186.7-2020mm (7.35-79.53in)	166.7mm (6.56in)
RGB		501	Red 71 Green 153 Blue 25 RGB 221	Red 22 Green 47 Blue 8 RGB 67	15.6	4.75	LiNi BLADE-S RGB	103.3-2020mm (4.07-79.53in)	83.3mm (3.28in)

* Performance data: KKLN-01 15° lens, RGB

Length Code		Fixture Length ¹		LED Strip ²		End Cap Dimension ³		Wattage (W)	Output (lm)			
Metric	Imperial(US)	Metric	Imperial(US)	Metric	Imperial(US)	Metric	Imperial(US)		R	G	B	W
m0103	i0004	103mm	4.07in	83mm	3.28in	5mm	0.20in	1.30	9	19	3	27
m0187	i0007	187mm	7.35in	167mm	6.56in	5mm	0.20in	2.60	17	37	6	54
m0270	i0011	270mm	10.63in	250mm	9.84in	5mm	0.20in	3.90	26	56	9	81
m0353	i0014	353mm	13.91in	333mm	13.12in	5mm	0.20in	5.20	35	75	12	108
m0437	i0017	437mm	17.19in	417mm	16.41in	5mm	0.20in	6.50	44	94	16	135
m0520	i0020	520mm	20.47in	500mm	19.69in	5mm	0.20in	7.80	52	112	19	162
m0603	i0024	603mm	23.76in	583mm	22.97in	5mm	0.20in	9.10	61	131	22	189
m0687	i0027	687mm	27.04in	667mm	26.25in	5mm	0.20in	10.40	70	150	25	216
m0770	i0030	770mm	30.32in	750mm	29.53in	5mm	0.20in	11.70	78	168	28	243
m0853	i0034	853mm	33.60in	833mm	32.81in	5mm	0.20in	13.00	87	187	31	270
m0937	i0037	937mm	36.88in	917mm	36.09in	5mm	0.20in	14.30	96	206	34	297
m1020	i0040	1020mm	40.16in	1000mm	39.37in	5mm	0.20in	15.60	105	225	37	324
m1103	i0043	1103mm	43.44in	1083mm	42.65in	5mm	0.20in	16.90	113	243	41	352
m1187	i0047	1187mm	46.72in	1167mm	45.94in	5mm	0.20in	18.20	122	262	44	379
m1270	i0050	1270mm	50.00in	1250mm	49.22in	5mm	0.20in	19.50	131	281	47	406
m1353	i0053	1353mm	53.29in	1333mm	52.50in	5mm	0.20in	20.80	139	300	50	433
m1437	i0057	1437mm	56.57in	1417mm	55.78in	5mm	0.20in	22.10	148	318	53	460
m1520	i0060	1520mm	59.85in	1500mm	59.06in	5mm	0.20in	23.40	157	337	56	487
m1603	i0063	1603mm	63.13in	1583mm	62.34in	5mm	0.20in	24.70	165	356	59	514
m1687	i0066	1687mm	66.41in	1667mm	65.62in	5mm	0.20in	26.00	174	374	62	541
m1770	i0070	1770mm	69.69in	1750mm	68.90in	5mm	0.20in	27.30	183	393	66	568
m1853	i0073	1853mm	72.97in	1833mm	72.18in	5mm	0.20in	28.60	192	412	69	595
m1937	i0076	1937mm	76.25in	1917mm	75.47in	5mm	0.20in	29.90	200	431	72	622
m2020	i0080	2020mm	79.53in	2000mm	78.75in	5mm	0.20in	31.20	209	449	75	649

¹ Actual total overall length of light fixture (LED strip + end caps + void/wire hole)

² Actual length of PCB strip

³ Actual length of 2x end caps

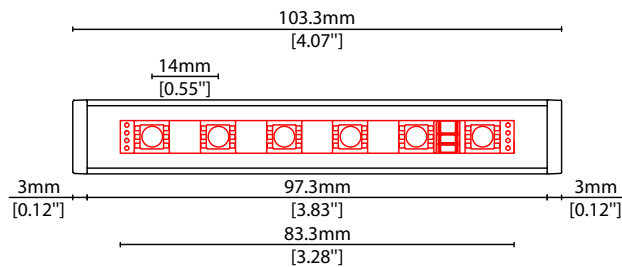

Linear

LiNi BLADE-S RGB Options

KKDC

COVER/LENS OPTIONS

* Options are an integral part of the fixture ordering codes. Please refer to **Code Table** pages.



C Diffused Cover
Polycarbonate finish
W15.6/H31mm (W0.61/H1.22")

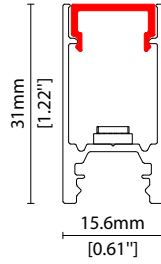

S KKLN-01D 15° lens
15° beam linear lens,
co-extruded PMMA
W15.6/H31mm (W0.61/H1.22")

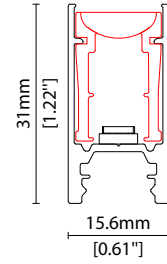

R KKLN-01U 46° lens
46° beam linear lens,
co-extruded PMMA
W15.6/H31mm (W0.61/H1.22")

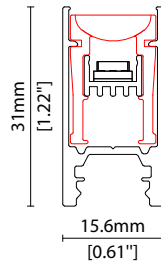

POWER FEED OPTIONS

* Options are an integral part of the fixture ordering codes. Please refer to **Code Table** pages.

0300 S00X 300mm (11.81") Single no sheath tail

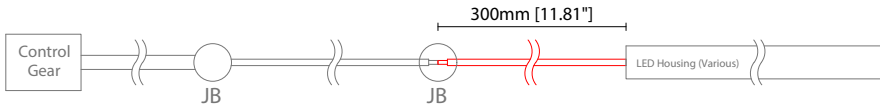

0300 D00X 300mm (11.81") Double no sheath tail

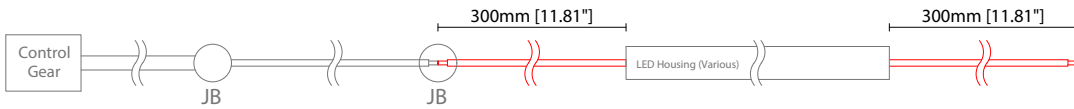

1000 S00X 1000mm (39.37") Single no sheath tail

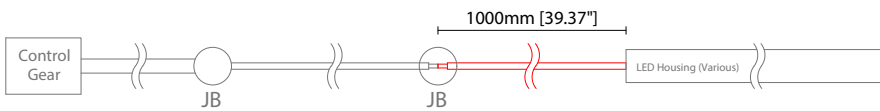

1000 D00X 1000mm (39.37") Double no sheath tail

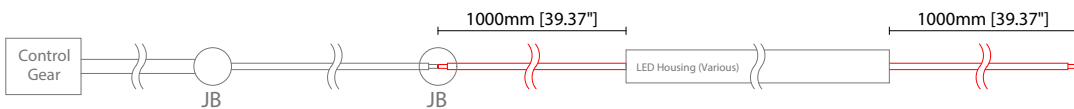

3000 S00H 3000mm (118.11") Suspension single no sheath tail

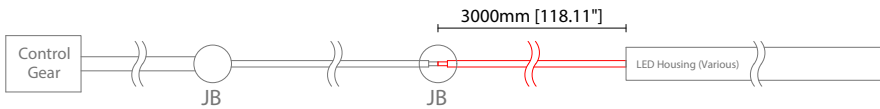

Key

Control Gear Power supply, sub-controllers & control systems
 JB Junction box / cable connection

MOUNTING ACCESSORIES

Note: Accessories are to be ordered separately with corresponding code shown below.



KKCP-10

Concealed clip
(allow 2 per metre/40in)
S/Steel finish
L20/W15.6/H31mm
(L0.79/W0.61/H1.22")

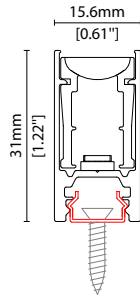

KKSW-06

Suspension mounting kit
(allow 2 per metre/40in)
S/Steel finish
L14.9/W16/H3031mm
(L0.59/W0.63/H119.33")

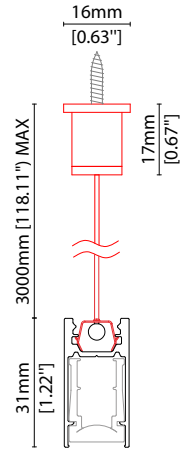

POWER FEED

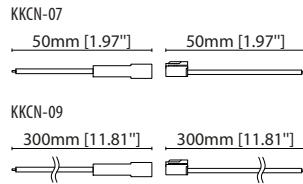

KKCN-07 50mm (1.97in) pair
KKCN-09 300mm (11.81in) pair
4 PIN RGB male + female
connector set

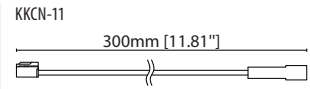

KKCN-11
4 PIN RGB 300mm (11.81in)
extension lead

KKDC CONTROL



IP20
Plastic housing
L170/W59/H29mm
(L6.69/W2.32/H1.14in)

KKDM-06 1-10V
visDIM dimmable sub-controller
(4 x 8A max @ 12-36V)



IP20
Plastic housing
L170/W53.4/H28mm
(L6.69/W2.10/H1.10in)

KKSC-05 DMX
visDIM dimmable sub-controller
(4 x 5A max @ 12-36V)

Linear

LiNi BLADE-S RGB Accessories

KKDC

KKDC CONTROL (CONTINUED)



IP20
Plastic housing
L170/W59/H29mm
(L6.69/W2.32/H1.14in)

KKDL-02 DALI

visDIM dimmable sub-controller
(4 x 8A max @ 12-36V)



IP20
Plastic housing
L166/W53.4/H23mm
(L6.54/W2.10/H0.91in)

KKDL-03 DALI

visDIM dimmable sub-controller
(4 x 5A max @ 12-36V)

AVAILABLE PSU OPTIONS

Control Mode	PSU (Order Code)	Input Voltage AC	Output Voltage DC	Rated Output Current	Rated Power	Dim %	IP Rating
Switched	CEN-60-24	90-295V	24V	2.5A	60W	-	IP67
	HLG-60H-24	90-305V	24V	2.5A	60W	-	IP67
	HLG-100H-24	90-305V	24V	4.0A	100W	-	IP67
	HLG-150H-24	90-305V	24V	6.3A	150W	-	IP67
	HLG-240H-24	90-305V	24V	10A	240W	-	IP67
0-10V (1-10V)	PWM-40-24	90-305V	24V	1.67A	40W	100-0.15 (100-10)	IP67
	PWM-60-24	90-305V	24V	2.5A	60W	100-0.15 (100-10)	IP67
	PWM-90-24	90-305V	24V	3.67A	90W	100-0.15 (100-10)	IP67
	PWM-120-24	90-305V	24V	5.0A	120W	100-0.15 (100-10)	IP67
DALI	LIN100A1	120-277V	24V	1A per channel	100W	100-0.1	IP66/IP40
DMX RGB	LIN100A1	120-277V	24V	1.33A per channel	100W	100-0.1	IP66/IP40
DMX RGBW	LIN100A1	120-277A	24V	1A per channel	100W	100-0.1	IP66/IP40

Flicker Free Options - Combination of PSU+ sub-controller

Control Mode	PSU (Order Code)	Sub-controller (Order Code)	Input Voltage AC	Output Voltage DC	Rated Output Current	Rated Power	Dim %	IP Rating PSU/ Sub-controller
0-10V or 1-10V	CEN-60-24	KKDM-06	90-295V	24V	2.5A	60W	100-0.9	IP67/IP20
	HLG-60H-24	KKDM-06	90-295V	24V	2.5A	60W	100-0.9	IP67/IP20
	HLG-100H-24	KKDM-06	90-295V	24V	4.0A	100W	100-0.9	IP67/IP20
	HLG-150H-24	KKDM-06	90-295V	24V	6.3A	150W	100-0.9	IP67/IP20
	HLG-240H-24	KKDM-06	90-295V	24V	10.0A	240W	100-0.9	IP67/IP20
DALI	CEN-60-24	KKDL-02/03	90-295V	24V	2.5A	60W	100-0.1	IP67/IP20
	HLG-60H-24	KKDL-02/03	90-305V	24V	2.5A	60W	100-0.1	IP67/IP20
	HLG-100H-24	KKDL-02/03	90-305V	24V	4.0A	100W	100-0.1	IP67/IP20
	HLG-150H-24	KKDL-02/03	90-305V	24V	6.3A	150W	100-0.1	IP67/IP20
	HLG-240H-24	KKDL-02/03	90-305V	24V	10.0A	240W	100-0.1	IP67/IP20
DMX RGB	CEN-60-24	KKSC-05	90-295V	24V	2.5A	60W	100-0.9	IP67/IP20
	HLG-60H-24	KKSC-05	90-305V	24V	2.5A	60W	100-0.9	IP67/IP20
	HLG-100H-24	KKSC-05	90-305V	24V	4A	100W	100-0.9	IP67/IP20
	HLG-150H-24	KKSC-05	90-305V	24V	6.3A	150W	100-0.9	IP67/IP20
	HLG-240H-24	KKSC-05	90-305V	24V	10.0A	240W	100-0.9	IP67/IP20

¹ The items shown above cover the most frequently used specification but does not exhaust the possible options

² PSU and/or driver can be chosen from the table, or KKDC may recommend the best option upon receipt of the controls requirement and installation environment

³ Electrical shop drawing will include detailed information of PSU and relevant control drivers

⁴ Cut sheets are available on the controls section of www.kkdc.lighting or upon request