

Linear

MiMi 207 Fixture Guide

KKDÖ

Indoor/Outdoor | Surface | Mid dynamic output up to 590lm/m (180lm/ft)



Key applications

- ✓ Architectural detail
- ✓ Bathrooms
- ✓ Cove lighting
- ✓ Hand rail
- ✓ Indirect lighting
- ✓ Interior/Exterior
- ✓ Mirror back lighting
- ✓ Shelving display
- ✓ Special effect
- ✓ Under bench

Key features

- ✓ Custom lengths
- ✓ Diffusion: Spotting
- ✓ Dynamic white
- ✓ Extensive CCT range
- ✓ Form factor: Small
- ✓ IP54
- ✓ IP67
- ✓ Output mid

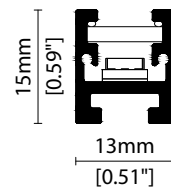

MOUNTING METHODS



KKCP-02 Clip



KKCP-14 Locking clip



KKBK-06 Fixed bracket



KKBK-05 Adjustable bracket



EB End Cap Bracket

Warm dim (Dynamic white)

Output Luminance %

min DIM1 Input Level max

— CH1 (Warmer)
— CH2 (Cooler)

LEDmix 207

CCT Selection 1 CCT Selection 2

LEDmix 209

CCT Selection 1 CCT Selection 2

LEDmix **warm dim** (Dynamic white) is a pre-programmed dimming curve setting enabling two different colour temperatures (CCTs) to blend harmoniously to achieve a warming lighting effect when dimmed.

KKDC LEDmix strips allow two separate CCT selections to be specified within the same PCB strip.

Use the table opposite to help determine which 2 CCT selections you require according to your preferred cool to warm dimming range.

**Note: The blended CCT is approx. 'cool-end' result at 100% brightness based on using the KKDC LED CCT specification.*

CCT Selection 1	CCT Selection 2	
	Blended CCT*	PCB CCT
1900K~	2000K 2100K 2200K 2300K 2500K 2600K 2700K 3000K 3500K	2100K PCB 2300K PCB 2500K PCB 2700K PCB 3000K PCB 3200K PCB 3500K PCB 4000K PCB 5000K PCB
2100K~	2200K 2300K 2400K 2600K 2700K 2800K 3000K 3600K	2300K PCB 2500K PCB 2700K PCB 3000K PCB 3200K PCB 3500K PCB 4000K PCB 5000K PCB
2300K~	2400K 2500K 2700K 2800K 2900K 3100K 3700K	2500K PCB 2700K PCB 3000K PCB 3200K PCB 3500K PCB 4000K PCB 5000K PCB
2500K~	2600K 2800K 2800K 3000K 3200K 3800K	2700K PCB 3000K PCB 3200K PCB 3500K PCB 4000K PCB 5000K PCB
2700K~	2900K 3000K 3100K 3400K 3900K	3000K PCB 3200K PCB 3500K PCB 4000K PCB 5000K PCB
3000K~	3100K 3300K 3500K 4000K	3200K PCB 3500K PCB 4000K PCB 5000K PCB
3200K~	3300K 3600K 4100K	3500K PCB 4000K PCB 5000K PCB
3500K~	3700K 4300K	4000K PCB 5000K PCB
4000K~	5100K	5000K PCB

Tuneable white

Channel Mix Ratio %

min DIM1 Input Level max

— CH1 (Warmer)
— CH2 (Cooler)

LEDmix 207

CCT Selection 1 CCT Selection 2

LEDmix 209

CCT Selection 1 CCT Selection 2

LEDmix **tunable white** enables two different LED colour temperatures (CCTs) to be specified within the same LEDmix strip.

Each CCT selection can then be independently controlled (via your dimming control system) to adjust the warm & cool light output (CCT selections) and thus tailor a blended light colour of your choosing.

CCT Selection 1	CCT Selection 2
1900K~	2100K 2300K 2500K 2700K 3000K 3200K 3500K 4000K 5000K
2100K~	2300K 2500K 2700K 3000K 3200K 3500K 4000K 5000K
2300K~	2500K 2700K 3000K 3200K 3500K 4000K 5000K
2500K~	2700K 3000K 3200K 3500K 4000K 5000K
2700K~	3000K 3200K 3500K 4000K 5000K
3000K~	3200K 3500K 4000K 5000K
3200K~	3500K 4000K 5000K
3500K~	4000K 5000K
4000K~	5000K

Linear

MiMi 207

Specification sheet

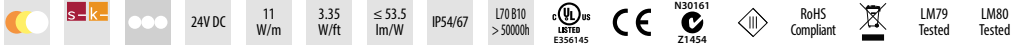

Dimension	H15/W13/L103.3-2020mm* (H0.59/W0.51/L4.07-79.53in*) *Nano Louvre = 1020mm/40.16in Max
PCB increment	83.3mm increment/2000mm* (3.28in increment/78.74in*) *Nano Louvre = 1000mm/39.37in Max
LED pitch	13.9mm - 144 LED/m (0.55in - 44LED/ft) between same coloured LEDs
Chip	s-line Toyoda Gosei k-line Toyoda Gosei or Equivalent
Beam angle	75° (Clear Cover)/95° (Diffused cover)/35° (Nano Louvre)/63° (Black Cover)
Colours	s-line 1900K/2100K/2300K/2500K/2700K/3000K/3500K/4000K/5000K k-line 1900K/2100K/2300K/2500K/2700K/3000K/3500K/4000K/5000K
Bin/Step	s-line 2.5-step MacAdam ellipse k-line 3-step MacAdam ellipse
CRI	≥ 90
Lifetime	50,000 hours @ 25°C (50,000 hours @ 77°F)
Operating temp	T _a = -25 to 60°C (T _C max = 69.4°C) T _a = -13 to 140°F (T _C max = 156.9°F)
IP rating	IP54/IP67
Finish	Silver anodised
Cover/lens	Clear/Diffused/Diffused+Nano Louvre/Black
Mounting	Surface mounting via clips or brackets
Power feed	Sheathed hardwire tails or male/female connectors
Control	0-10V/1-10V/DMX/DALI



LED Grading Key

Exclusive Grade

s-line*	*KKDC tuned CCT range
2.5-step CCT range	CCT range

Base Grade

k-line	3-step commercial range Energy Star CCTs
---------------	---

PERFORMANCE DATA @ 2100K + 5000K

Power consumption	Supply voltage	Supply current
11W/m (3.35W/ft)	24V DC	0.46A/m (0.14A/ft)

Colour Rendering Index (CRI)

	R1	R2	R3	R4	R5	R6	R7	R8	R9	R10	R11	R12	R13	R14
k-line	94	97	98	93	93	96	92	83	60	93	94	82	95	99

	Clear	Diffused	Diffused + Nano Louvre	Black	CRI	R9	Rf	Rg
s-line	590lm/m (180lm/ft) 53.5lm/W	470lm/m (142lm/ft) 42.5lm/W	121lm/m (37lm/ft) 11lm/W	350lm/m (107lm/ft) 31.8lm/W	93	62	-	-
k-line	580lm/m (177lm/ft) 52.7lm/W	460lm/m (140lm/ft) 41.9lm/W	118lm/m (36lm/ft) 10.7lm/W	345lm/m (105lm/ft) 31.4lm/W	92	60	-	-

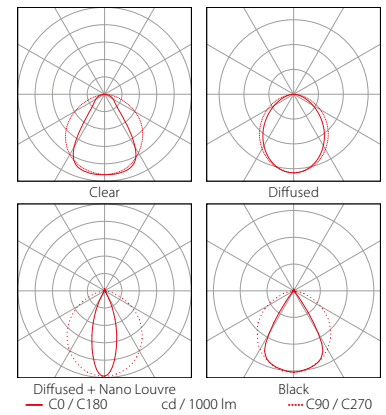
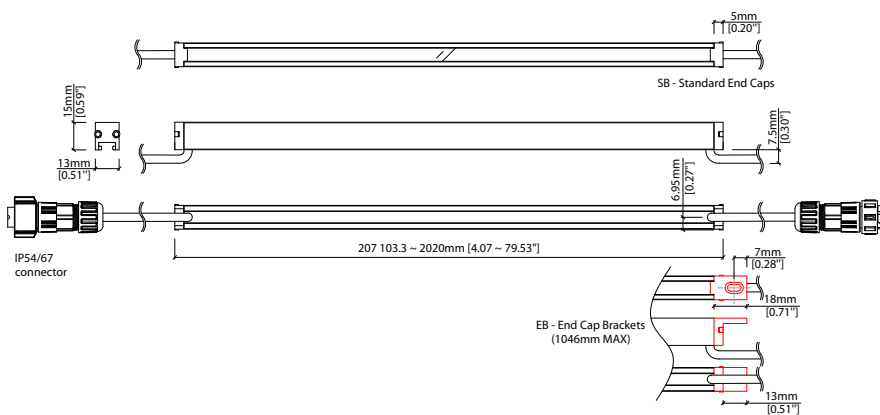

Data derived from independent UKAS/IESNA LM-79-08 accredited testing of production samples.

FIXTURE

Model	Finish	Cover ¹	Grade ²	LED	Colour (CCT)	Length Availability ³	IP	Cable Length	Power Feed ⁴	Fixing	Input																																																																																																																																																					
MiMi	MI	Silver Anodised	SA	Clear	B	s	s	207	1900K	19	m	103.3-2020mm 83.3mm increments	IP54	54	300mm/ 11.81"	0300	Single ø4.3mm sheath tail	S00A	Standard End Cap	SB	DC 24V	g																																																																																																																																										
																							Diffused	C	k	k	2100K	21	i	4.07-79.53in 3.28in increments	IP67 ⁸	67	Double ø4.3mm sheath tail	D00A	End Cap Bracket	EB																																																																																																																												
																																					Diffused + Nano Louvre ^{5,6}	CN	Y	2300K	23	2500K	25	2700K	27	3000K	30	3500K	35	4000K	40	5000K	50	(Specify length code OR total run length)	Single ø4.3mm sheath IP67 connector ⁹	S67A	Double ø4.3mm sheath IP67 connector ⁹	D67A																																																																																																						
																																																											Black	Y	2700K	27	3000K	30	3500K	35	4000K	40	5000K	50	(Specify length code OR total run length)	Single ø4.3mm sheath IP67 connector ⁹	S67A	Double ø4.3mm sheath IP67 connector ⁹	D67A																																																																																					
																																																																												2100K	21	2300K	23	2500K	25	2700K	27	3000K	30	3500K	35	4000K	40	5000K	50	(Specify length code OR total run length)	Single ø4.3mm sheath IP67 connector ⁹	S67A	Double ø4.3mm sheath IP67 connector ⁹	D67A																																																																
																																																																																																	2300K	23	2500K	25	2700K	27	3000K	30	3500K	35	4000K	40	5000K	50	(Specify length code OR total run length)	Single ø4.3mm sheath IP67 connector ⁹	S67A	Double ø4.3mm sheath IP67 connector ⁹	D67A																																													
																																																																																																																				2500K	25	2700K	27	3000K	30	3500K	35	4000K	40	5000K	50	(Specify length code OR total run length)	Single ø4.3mm sheath IP67 connector ⁹	S67A	Double ø4.3mm sheath IP67 connector ⁹	D67A																												
																																																																																																																																					2700K	27	3000K	30	3500K	35	4000K	40	5000K	50	(Specify length code OR total run length)	Single ø4.3mm sheath IP67 connector ⁹	S67A	Double ø4.3mm sheath IP67 connector ⁹	D67A													
																																																																																																																																																				3000K	30	3500K	35	4000K	40	5000K	50	(Specify length code OR total run length)	Single ø4.3mm sheath IP67 connector ⁹	S67A	Double ø4.3mm sheath IP67 connector ⁹	D67A
4000K	40	5000K	50	(Specify length code OR total run length)	Single ø4.3mm sheath IP67 connector ⁹	S67A	Double ø4.3mm sheath IP67 connector ⁹	D67A																																																																																																																																																								
									5000K	50	(Specify length code OR total run length)	Single ø4.3mm sheath IP67 connector ⁹	S67A	Double ø4.3mm sheath IP67 connector ⁹	D67A																																																																																																																																																	

¹ Refer to **Cover Options** on **Options** pages ² Refer to **LED Grading Key** on **Specification sheet** page ³ Refer to **Length Availability List** or enter total run length instead of length code

⁴ Refer to **Power Feed Options** on **Options** pages ⁵ Nano Louvre only available with IP54 option ⁶ Max length available with Nano Louvre is 1020mm

⁷ LEDmix requires two colour temperature choices ⁸ Due to the clear, flush potted polyurethane top layer on IP67 MiMi a colour shift of +/-20K should be expected

⁹ IP67 connectors are used for both IP67 and IP54 product housings

Code Example:

MI	-	SA	-	CN	-	s	-	207	-	2150	-	m	-	520	-	67	-	0300	-	S00A	-	EB	-	g
MiMi		Silver Anodised		Diffused + Nano Louvre				207		2100K+5000K		519.8mm		IP67		300mm/11.81"		Single ø4.3mm sheath tail		End Cap Bracket		DC 24V		

ACCESSORIES

Mounting Accessories

KKCP-02	Clip (1no.)
KKCP-52	Clip (500no.)
KKCP-14	Lock Clip
KKBK-06	Fixed bracket
KKBK-05	Adjustable bracket

* Refer to **Mounting accessories** on **Accessories** pages

Connection Accessories

CN67-4P-0300	IP67 4 PIN LEDmix male & female 300mm/11.81" pair
CN67-4P-1000	IP67 4 PIN LEDmix male & female 1000mm/39.37" pair
CN67-4P-3000	IP67 4 PIN LEDmix male & female 3000mm/118.11" pair

* Refer to **Power feed** on **Accessories** pages

Exterior Junction Boxes

KKJB-07	IP67 Slim J-Box
KKJB-07R	Potting Resin for IP67 Slim J-Box

* Refer to **Exterior Junction Boxes** on **Accessories** pages

PSU/Driver

0-10V/1-10V/DALI/DMX

* Refer to **Driver/PSU Options** page for details or provide requirement and KKDC to offer the suitable option

LED ENGINE VARIANTS (LED STRIP TYPE)

Colour	Output	LED	Lumen/m	Lumen/ft	W/m	W/ft	Spec Doc	Length	Increment
Single CCT	Low	352	340	103	5.5	1.67	MiMi 352	103.3-2020mm (4.07-79.53in)	83.3mm (3.28in)
	Mid	504	820	250	12.5	3.81	MiMi 504	120-2020mm (4.72-79.53in)	100mm (3.94in)
	Mid	508	1130	344	17.5	5.33	MiMi 508	91.4-2020mm (3.60-79.53in)	71.4mm (2.81in)
	Mid	007	620	189	10.9	3.32	MiMi 007	103.4-2020mm (4.07-79.53in)	41.7mm (1.64in)
	Mid	010	920	280	10	3.05	MiMi A010	97-2020mm (3.82-79.53in)	38.46mm (1.51in)
	Max	020	1840	561	20	6.10	MiMi A020	97-2020mm (3.82-79.53in)	38.46mm (1.51in)
	Warm Dim/Dynamic White	Mid	207	590	180	11	3.35	MiMi 207	103.3-2020mm (4.07-79.53in)
RGB	Mid	208	1000	338	15.6	4.75	MiMi 208	186.7-2020mm (7.35-79.53in)	166.7mm (6.56in)
		501	Red 98 Green 210 Blue 35 RGB 305	Red 30 Green 64 Blue 11 RGB 93	15.6	4.75	MiMi RGB	103.3-2020mm (4.07-79.53in)	83.3mm (3.28in)

* Performance data: s-line, clear cover, 2100K + 5000K

MiMi 207

Length Availability List



Length Code		Fixture Length ¹		LED Strip ²		End Cap Dimension ³		Wattage (W)	Output (lm)
Metric	Imperial(US)	Metric	Imperial(US)	Metric	Imperial(US)	Metric	Imperial(US)		MIX (Test Data)
m0103	i0004	103mm	4.07in	83mm	3.28in	10mm	0.39in	0.92	49
m0187	i0007	187mm	7.35in	167mm	6.56in	10mm	0.39in	1.83	98
m0270	i0011	270mm	10.63in	250mm	9.84in	10mm	0.39in	2.75	147
m0353	i0014	353mm	13.91in	333mm	13.12in	10mm	0.39in	3.67	196
m0437	i0017	437mm	17.19in	417mm	16.41in	10mm	0.39in	4.58	245
m0520	i0020	520mm	20.47in	500mm	19.69in	10mm	0.39in	5.50	294
m0603	i0024	603mm	23.76in	583mm	22.97in	10mm	0.39in	6.42	343
m0687	i0027	687mm	27.04in	667mm	26.25in	10mm	0.39in	7.33	392
m0770	i0030	770mm	30.32in	750mm	29.53in	10mm	0.39in	8.25	441
m0853	i0034	853mm	33.60in	833mm	32.81in	10mm	0.39in	9.17	490
m0937	i0037	937mm	36.88in	917mm	36.09in	10mm	0.39in	10.08	539
m1020	i0040	1020mm	40.16in	1000mm	39.37in	10mm	0.39in	11.00	589
m1103	i0043	1103mm	43.44in	1083mm	42.65in	10mm	0.39in	11.92	638
m1187	i0047	1187mm	46.72in	1167mm	45.94in	10mm	0.39in	12.83	687
m1270	i0050	1270mm	50.00in	1250mm	49.22in	10mm	0.39in	13.75	736
m1353	i0053	1353mm	53.29in	1333mm	52.50in	10mm	0.39in	14.67	785
m1437	i0057	1437mm	56.57in	1417mm	55.78in	10mm	0.39in	15.58	834
m1520	i0060	1520mm	59.85in	1500mm	59.06in	10mm	0.39in	16.50	883
m1603	i0063	1603mm	63.13in	1583mm	62.34in	10mm	0.39in	17.42	932
m1687	i0066	1687mm	66.41in	1667mm	65.62in	10mm	0.39in	18.33	981
m1770	i0070	1770mm	69.69in	1750mm	68.90in	10mm	0.39in	19.25	1030
m1853	i0073	1853mm	72.97in	1833mm	72.18in	10mm	0.39in	20.17	1079
m1937	i0076	1937mm	76.25in	1917mm	75.47in	10mm	0.39in	21.08	1128
m2020	i0080	2020mm	79.53in	2000mm	78.75in	10mm	0.39in	22.00	1177

¹ Actual total overall length of light fixture (LED strip + end caps + void/wire hole)

² Actual length of PCB strip

³ Actual length of 2x end caps

Standard End Caps (SB)

*Bracket End Caps (EB)
Increases overall standard length by 26mm (2x13mm)

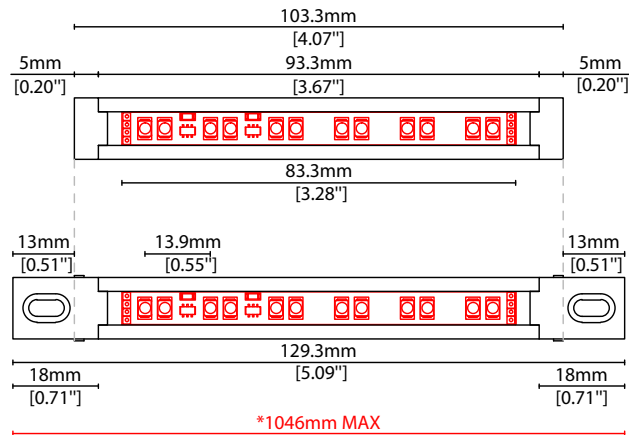

***IMPORTANT NOTE:**
DUE TO POTENTIAL PROFILE 'SAGGING' THE MAX LENGTH AVAILABLE WITH END CAP BRACKETS IS 1046mm.

COVER OPTIONS

* Options are an integral part of the fixture ordering codes. Please refer to **Code Table** pages.

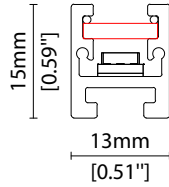

B Clear Cover
Polycarbonate
W13/H15mm (W0.51"/H0.59")

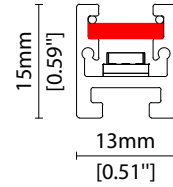

C Diffused Cover
Polycarbonate finish
W13/H15mm (W0.51"/H0.59")

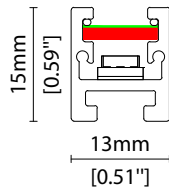

CN Diffused Cover + Nano Louvre
Polycarbonate cover with anti-glare, 30° cut-off view angle
W13/H15mm (W0.51"/H0.59")

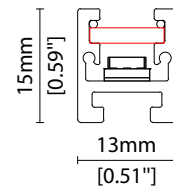

Y Black Clear Cover
Dark tinted translucent polycarbonate
60% light output
W13/H15mm (W0.51"/H0.59")

END CAP OPTION

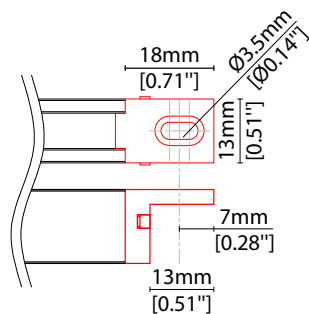

EB End Cap Bracket (Pair)
Handrail installation
Compatible up to 1m/40"
L18/W13/H15mm
(L0.7/W0.51/H0.59")

POWER FEED OPTIONS

* Options are an integral part of the fixture ordering codes. Please refer to **Code Table** pages.

0300 S00A 300mm (11.81") Single \varnothing 4.3mm sheath tail

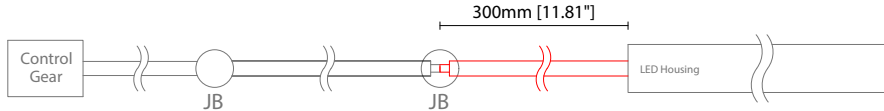

0300 D00A 300mm (11.81") Double \varnothing 4.3mm sheath tail

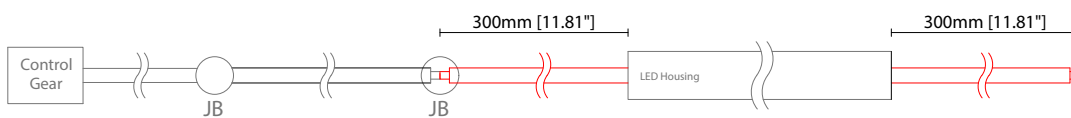

0300 S67A 300mm (11.81") Single \varnothing 4.3mm sheath IP67 connector

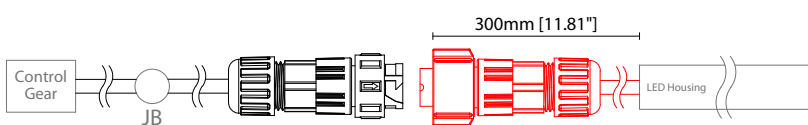

0300 D67A 300mm (11.81") Double \varnothing 4.3mm sheath IP67 connector

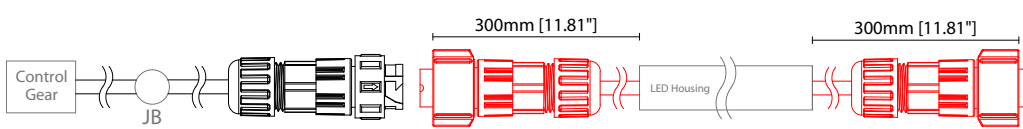

IP67 4 Pin Connector

Female connector
4 PIN (IP67)

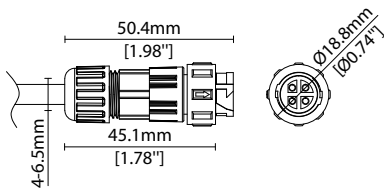

Male connector
4 PIN (IP67)

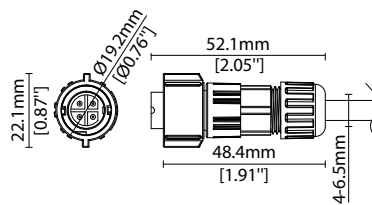

Key

- Control Gear Power supply, sub-controllers & control systems
- JB Junction box / cable connection

MOUNTING ACCESSORIES

Note: Accessories are to be ordered separately with corresponding code shown below.

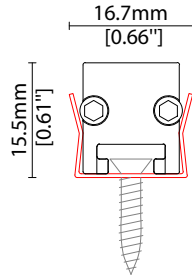

KKCP-02 (1no.)
KKCP-52 (500no.)
 Clip (allow 3 per metre/40in)
 S/Steel finish
 L25/W16.7/H15.5mm
 (L0.98/W0.66/H0.61")

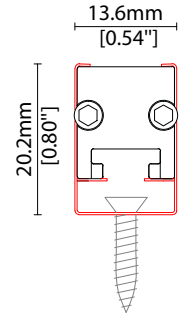

KKCP-14
 Lock clip (allow 2 per metre/40in)
 S/Steel finish
 L25/W14/H21mm
 (L0.98/W0.55/H0.83")

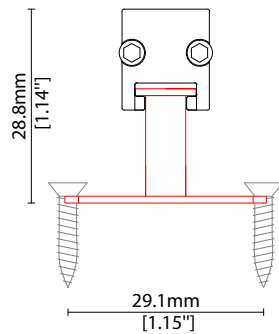

KKBK-06
 Fixed bracket (allow 3 per metre/40in)
 S/Steel finish
 L20/W29.1/H28.8mm
 L0.79/W1.15/H1.13"

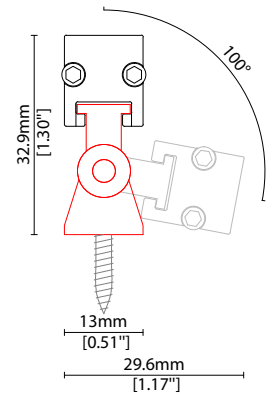

KKBK-05
 Adjustable bracket
 (allow 2 per metre/40in)
 S/Steel finish
 W13/H32.9mm
 W0.51/H1.3"

POWER FEED

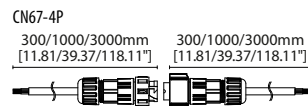

CN67-4P-0300 300mm (11.81in) pair
CN67-4P-1000 1000mm (39.37in) pair
CN67-4P-3000 3000mm (118.11in) pair

IP67
 4 PIN male + female (RGB/LEDmix) connector set

EXTERIOR JUNCTION BOXES



KKJB-07

IP67 Slim J-Box
(including type A,B,C, D bushings)



KKJB-07R

Potting resin for IP67 Slim J-Box

KKDC CONTROL



KKDM-06 1-10V

visDIM dimmable sub-controller
(4 x 8A max @ 12-36V)

IP20
Plastic housing
L170/W59/H29mm
(L6.69/W2.32/H1.14in)



KKSC-05 DMX

visDIM dimmable sub-controller
(4 x 5A max @ 12-36V)

IP20
Plastic housing
L170/W53.4/H28mm
(L6.69/W2.10/H1.10in)



KKDL-02 DALI

visDIM dimmable sub-controller
(4 x 8A max @ 12-36V)

IP20
Plastic housing
L170/W59/H29mm
(L6.69/W2.32/H1.14in)



KKDL-03 DALI

visDIM dimmable sub-controller
(4 x 5A max @ 12-36V)

IP20
Plastic housing
L166/W53.4/H23mm
(L6.54/W2.10/H0.91in)

AVAILABLE PSU OPTIONS

Control Mode	PSU (Order Code)	Input Voltage AC	Output Voltage DC	Rated Output Current	Rated Power	Dim %	IP Rating
Switched	CEN-60-24	90-295V	24V	2.5A	60W	-	IP67
	HLG-60H-24	90-305V	24V	2.5A	60W	-	IP67
	HLG-100H-24	90-305V	24V	4.0A	100W	-	IP67
	HLG-150H-24	90-305V	24V	6.3A	150W	-	IP67
	HLG-240H-24	90-305V	24V	10A	240W	-	IP67
0-10V (1-10V)	PWM-40-24	90-305V	24V	1.67A	40W	100-0.15 (100-10)	IP67
	PWM-60-24	90-305V	24V	2.5A	60W	100-0.15 (100-10)	IP67
	PWM-90-24	90-305V	24V	3.67A	90W	100-0.15 (100-10)	IP67
	PWM-120-24	90-305V	24V	5.0A	120W	100-0.15 (100-10)	IP67
DALI	LIN100A1	120-277V	24V	1A per channel	100W	100-0.1	IP66/IP40
DMX RGB	LIN100A1	120-277V	24V	1.33A per channel	100W	100-0.1	IP66/IP40
DMX RGBW	LIN100A1	120-277A	24V	1A per channel	100W	100-0.1	IP66/IP40

Flicker Free Options - Combination of PSU+ sub-controller

Control Mode	PSU (Order Code)	Sub-controller (Order Code)	Input Voltage AC	Output Voltage DC	Rated Output Current	Rated Power	Dim %	IP Rating PSU/ Sub-controller
0-10V or 1-10V	CEN-60-24	KKDM-06	90-295V	24V	2.5A	60W	100-0.9	IP67/IP20
	HLG-60H-24	KKDM-06	90-295V	24V	2.5A	60W	100-0.9	IP67/IP20
	HLG-100H-24	KKDM-06	90-295V	24V	4.0A	100W	100-0.9	IP67/IP20
	HLG-150H-24	KKDM-06	90-295V	24V	6.3A	150W	100-0.9	IP67/IP20
	HLG-240H-24	KKDM-06	90-295V	24V	10.0A	240W	100-0.9	IP67/IP20
DALI	CEN-60-24	KKDL-02/03	90-295V	24V	2.5A	60W	100-0.1	IP67/IP20
	HLG-60H-24	KKDL-02/03	90-305V	24V	2.5A	60W	100-0.1	IP67/IP20
	HLG-100H-24	KKDL-02/03	90-305V	24V	4.0A	100W	100-0.1	IP67/IP20
	HLG-150H-24	KKDL-02/03	90-305V	24V	6.3A	150W	100-0.1	IP67/IP20
	HLG-240H-24	KKDL-02/03	90-305V	24V	10.0A	240W	100-0.1	IP67/IP20
DMX RGB	CEN-60-24	KKSC-05	90-295V	24V	2.5A	60W	100-0.9	IP67/IP20
	HLG-60H-24	KKSC-05	90-305V	24V	2.5A	60W	100-0.9	IP67/IP20
	HLG-100H-24	KKSC-05	90-305V	24V	4A	100W	100-0.9	IP67/IP20
	HLG-150H-24	KKSC-05	90-305V	24V	6.3A	150W	100-0.9	IP67/IP20
	HLG-240H-24	KKSC-05	90-305V	24V	10.0A	240W	100-0.9	IP67/IP20

¹ The items shown above cover the most frequently used specification but does not exhaust the possible options

² PSU and/or driver can be chosen from the table, or KKDC may recommend the best option upon receipt of the controls requirement and installation environment

³ Electrical shop drawing will include detailed information of PSU and relevant control drivers

⁴ Cut sheets are available on the controls section of www.kkdc.lighting or upon request