

Linear

MiMi RGB Fixture Guide

KKDÖ

Indoor/Outdoor | Surface | RGB output



Key applications

- ✓ Architectural detail
- ✓ Bathrooms
- ✓ Cove lighting
- ✓ Hand rail
- ✓ Indirect lighting
- ✓ Interior/Exterior
- ✓ Mirror back lighting
- ✓ Shelving display
- ✓ Special effect
- ✓ Under bench

Key features

- ✓ Custom lengths
- ✓ Diffusion: Spotting
- ✓ Form factor: Small
- ✓ IP54
- ✓ IP67
- ✓ RGB

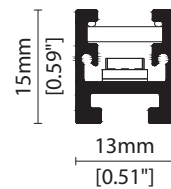

MOUNTING METHODS



KKCP-02 Clip



KKCP-14 Locking clip



KKBK-06 Fixed bracket



KKBK-05 Adjustable bracket



EB End Cap Bracket

Linear

MiMi RGB

Specification sheet



| | |
|-----------------------|--|
| Dimension | H15/W13/L103.4-2020mm* (H0.59/W0.51/L4.07-79.53in*) *Nano Louvre = 1020mm/40.16in Max |
| PCB increment | 83.3mm increment/2000mm* (3.28in increment/78.74in*) *Nano Louvre = 1000mm/39.37in Max |
| LED pitch | 13.9mm - 72LED/m (0.55in - 22LED/ft) |
| Chip | Red TEKCORE/Green EPILEDS/Blue 3E |
| Beam angle | 75° (Clear Cover)/95° (Diffused cover)/35° (Nano Louvre)/63° (Black Cover) |
| Colours | Red 620-625nm/Blue 455-460nm/Green 520-525nm |
| Bin/Step | 5nm tolerance |
| CRI | N/A |
| Lifetime | 50,000 hours @ 25°C (50,000 hours @ 77°F) |
| Operating temp | T _a = -25 to 55°C (T _c max = 70°C) T _a = -13 to 131°F (T _c max = 158°F) |
| IP rating | IP54/IP67 |
| Finish | Silver anodised |
| Cover/lens | Clear/Diffused/Diffused+Nano Louvre/Black |
| Mounting | Surface mounting via clips or brackets |
| Power feed | Sheathed hardwire tails or male/female connectors |
| Control | DMX/DALI |



PERFORMANCE DATA

| Power consumption | Supply voltage | Supply current |
|--------------------|----------------|--------------------|
| 15.6W/m (4.75W/ft) | 24V DC | 0.65A/m (0.20A/ft) |

| Clear | Diffused | Diffused + Nano Louvre | Black |
|---|--|--|--|
| Red: 98lm/m (30lm/ft) Green: 210lm/m (64lm/ft) Blue: 35lm/m (11lm/ft) RGB: 305lm/m (93lm/ft) | Red: 80lm/m (24lm/ft) Green: 172lm/m (52lm/ft) Blue: 29lm/m (9lm/ft) RGB: 250lm/m (76lm/ft) | Red: 21lm/m (6lm/ft) Green: 44lm/m (13lm/ft) Blue: 7lm/m (2lm/ft) RGB: 64lm/m (19lm/ft) | Red: 58lm/m (18lm/ft) Green: 126lm/m (38lm/ft) Blue: 21lm/m (6lm/ft) RGB: 183lm/m (56lm/ft) |

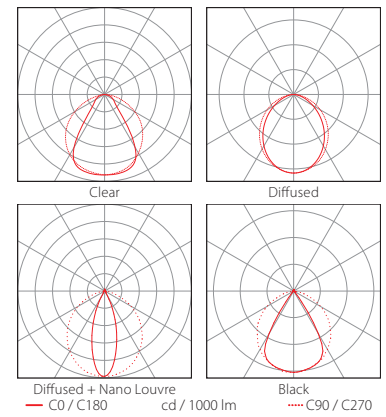
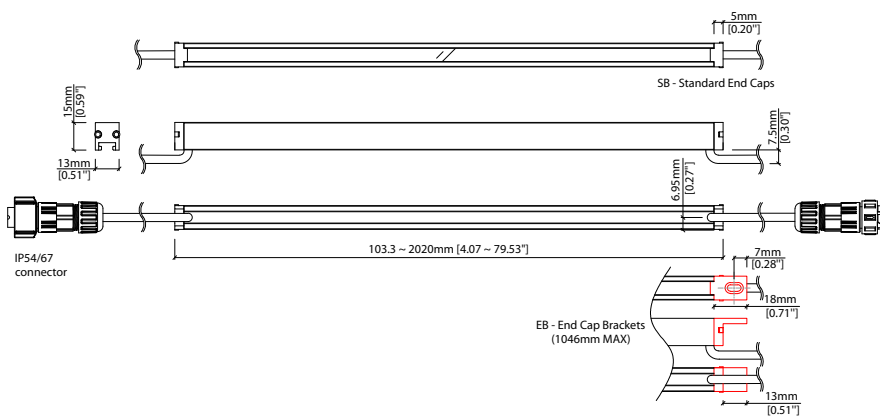

Data derived from production samples tested to UKAS/IESNA LM-79-08 standards.

See KKDC website for product document updates.

www.kkdc.lighting

MiMiRGBS-02.07EN-20220809

FIXTURE

| Model | Finish | Cover ¹ | Grade | LED | Colour (CCT) | Length Availability ² | IP | Cable Length | Power Feed ³ | Fixing | Input |
|---------|-----------------|---|-------------------|---|--------------|---|---------------------------------|--------------------------|--|---|----------|
| MiMi MI | Silver Anodised | SA Clear Diffused Diffused + Nano Louvre ⁴ Black | B C CN Y |  s | 501 RGB | m 103.3-2020mm 83.3mm increments i 4.07-79.53in 3.28in increments (Specify length code OR total run length) | IP54 54 IP67 ⁵ 67 | 300mm/ 11.81" 0300 | Single ø4.3mm sheath tail S00A Double ø4.3mm sheath tail D00A Single ø4.3mm sheath IP67 connector ⁶ S67A Double ø4.3mm sheath IP67 connector ⁶ D67A | Standard End Cap SB End Cap Bracket EB | DC 24V g |

¹ Refer to **Cover Options** on **Options** pages

² Refer to **Length Availability List** or enter total run length instead of length code

³ Refer to **Power Feed Options** on **Options** pages

⁴ Max length available with Nano Louvre is 1020mm

⁵ Due to the clear, flush potted polyurethane top layer on IP67 MiMi a colour shift of +/-20K should be expected

⁶ IP67 connectors are used for both IP67 and IP54 product housings

Code Example:

| | | | | | | | | | | | | | | | | | | | | | | | |
|------|---|-----------------|---|------------------------|---|---|---|-----|---|-----|---|---------|-----|------|----|--------------|------|---------------------------|------|-----------------|----|--------|---|
| MI | - | SA | - | CN | - | s | - | 501 | - | RGB | - | m | 520 | - | 67 | - | 0300 | - | S00A | - | EB | - | g |
| MiMi | | Silver Anodised | | Diffused + Nano Louvre | |  | | 501 | | RGB | | 519.8mm | | IP67 | | 300mm/11.81" | | Single ø4.3mm sheath tail | | End Cap Bracket | | DC 24V | |

ACCESSORIES

Mounting Accessories

| | |
|---------|--------------------|
| KKCP-02 | Clip (1no.) |
| KKCP-52 | Clip (500no.) |
| KKCP-14 | Lock Clip |
| KKBK-06 | Fixed bracket |
| KKBK-05 | Adjustable bracket |

* Refer to **Mounting accessories** on **Accessories** pages

Connection Accessories

| | |
|--------------|--|
| CN67-4P-0300 | IP67 4 PIN RGB male & female 300mm/11.81" pair |
| CN67-4P-1000 | IP67 4 PIN RGB male & female 1000mm/39.37" pair |
| CN67-4P-3000 | IP67 4 PIN RGB male & female 3000mm/118.11" pair |

* Refer to **Power feed** on **Accessories** pages

Exterior Junction Boxes

| | |
|----------|-----------------------------------|
| KKJB-07 | IP67 Slim J-Box |
| KKJB-07R | Potting Resin for IP67 Slim J-Box |

* Refer to **Exterior Junction Boxes** on **Accessories** pages

PSU/Driver

0-10V/1-10V/DALI/DMX

* Refer to **Driver/PSU Options** page for details or provide requirement and KKDC to offer the suitable option

LED ENGINE VARIANTS (LED STRIP TYPE)

| Colour | Output | LED | Lumen/m | Lumen/ft | W/m | W/ft | Spec Doc | Length | Increment |
|------------|------------------------|-----|---|---|------|------|-----------|-----------------------------|-----------------------------|
| Single CCT | Low | 352 | 340 | 103 | 5.5 | 1.67 | MiMi 352 | 103.3-2020mm (4.07-79.53in) | 83.3mm (3.28in) |
| | Mid | 504 | 820 | 250 | 12.5 | 3.81 | MiMi 504 | 120-2020mm (4.72-79.53in) | 100mm (3.94in) |
| | Mid | 508 | 1130 | 344 | 17.5 | 5.33 | MiMi 508 | 91.4-2020mm (3.60-79.53in) | 71.4mm (2.81in) |
| | Mid | 007 | 620 | 189 | 10.9 | 3.32 | MiMi 007 | 103.4-2020mm (4.07-79.53in) | 41.7mm (1.64in) |
| | Mid | 010 | 920 | 280 | 10 | 3.05 | MiMi A010 | 97-2020mm (3.82-79.53in) | 38.46mm (1.51in) |
| | Max | 020 | 1840 | 561 | 20 | 6.10 | MiMi A020 | 97-2020mm (3.82-79.53in) | 38.46mm (1.51in) |
| | Warm Dim/Dynamic White | Mid | 207 | 590 | 180 | 11 | 3.35 | MiMi 207 | 103.3-2020mm (4.07-79.53in) |
| Mid | | 208 | 1000 | 338 | 15.6 | 4.75 | MiMi 208 | 186.7-2020mm (7.35-79.53in) | 166.7mm (6.56in) |
| RGB | | 501 | Red 98 Green 210 Blue 35 RGB 305 | Red 30 Green 64 Blue 11 RGB 93 | 15.6 | 4.75 | MiMi RGB | 103.3-2020mm (4.07-79.53in) | 83.3mm (3.28in) |

* Performance data: clear cover, RGB

| Length Code | | Fixture Length ¹ | | LED Strip ² | | End Cap Dimension ³ | | Wattage (W) | Output (lm) | | | |
|-------------|--------------|-----------------------------|--------------|------------------------|--------------|--------------------------------|--------------|-------------|-------------|-----|----|-----|
| Metric | Imperial(US) | Metric | Imperial(US) | Metric | Imperial(US) | Metric | Imperial(US) | | R | G | B | W |
| m0103 | i0004 | 103mm | 4.07in | 83mm | 3.28in | 10mm | 0.39in | 1.30 | 8 | 18 | 3 | 25 |
| m0187 | i0007 | 187mm | 7.35in | 167mm | 6.56in | 10mm | 0.39in | 2.60 | 16 | 35 | 6 | 51 |
| m0270 | i0011 | 270mm | 10.63in | 250mm | 9.84in | 10mm | 0.39in | 3.90 | 25 | 53 | 9 | 76 |
| m0353 | i0014 | 353mm | 13.91in | 333mm | 13.12in | 10mm | 0.39in | 5.20 | 33 | 70 | 12 | 102 |
| m0437 | i0017 | 437mm | 17.19in | 417mm | 16.41in | 10mm | 0.39in | 6.50 | 41 | 88 | 15 | 127 |
| m0520 | i0020 | 520mm | 20.47in | 500mm | 19.69in | 10mm | 0.39in | 7.80 | 49 | 105 | 18 | 153 |
| m0603 | i0024 | 603mm | 23.76in | 583mm | 22.97in | 10mm | 0.39in | 9.10 | 57 | 123 | 20 | 178 |
| m0687 | i0027 | 687mm | 27.04in | 667mm | 26.25in | 10mm | 0.39in | 10.40 | 65 | 140 | 23 | 203 |
| m0770 | i0030 | 770mm | 30.32in | 750mm | 29.53in | 10mm | 0.39in | 11.70 | 74 | 158 | 26 | 229 |
| m0853 | i0034 | 853mm | 33.60in | 833mm | 32.81in | 10mm | 0.39in | 13.00 | 82 | 175 | 29 | 254 |
| m0937 | i0037 | 937mm | 36.88in | 917mm | 36.09in | 10mm | 0.39in | 14.30 | 90 | 193 | 32 | 280 |
| m1020 | i0040 | 1020mm | 40.16in | 1000mm | 39.37in | 10mm | 0.39in | 15.60 | 98 | 210 | 35 | 305 |
| m1103 | i0043 | 1103mm | 43.44in | 1083mm | 42.65in | 10mm | 0.39in | 16.90 | 106 | 228 | 38 | 330 |
| m1187 | i0047 | 1187mm | 46.72in | 1167mm | 45.94in | 10mm | 0.39in | 18.20 | 114 | 245 | 41 | 356 |
| m1270 | i0050 | 1270mm | 50.00in | 1250mm | 49.22in | 10mm | 0.39in | 19.50 | 123 | 263 | 44 | 381 |
| m1353 | i0053 | 1353mm | 53.29in | 1333mm | 52.50in | 10mm | 0.39in | 20.80 | 131 | 280 | 47 | 407 |
| m1437 | i0057 | 1437mm | 56.57in | 1417mm | 55.78in | 10mm | 0.39in | 22.10 | 139 | 298 | 50 | 432 |
| m1520 | i0060 | 1520mm | 59.85in | 1500mm | 59.06in | 10mm | 0.39in | 23.40 | 147 | 315 | 53 | 458 |
| m1603 | i0063 | 1603mm | 63.13in | 1583mm | 62.34in | 10mm | 0.39in | 24.70 | 155 | 333 | 55 | 483 |
| m1687 | i0066 | 1687mm | 66.41in | 1667mm | 65.62in | 10mm | 0.39in | 26.00 | 163 | 350 | 58 | 508 |
| m1770 | i0070 | 1770mm | 69.69in | 1750mm | 68.90in | 10mm | 0.39in | 27.30 | 172 | 368 | 61 | 534 |
| m1853 | i0073 | 1853mm | 72.97in | 1833mm | 72.18in | 10mm | 0.39in | 28.60 | 180 | 385 | 64 | 559 |
| m1937 | i0076 | 1937mm | 76.25in | 1917mm | 75.47in | 10mm | 0.39in | 29.90 | 188 | 403 | 67 | 585 |
| m2020 | i0080 | 2020mm | 79.53in | 2000mm | 78.75in | 10mm | 0.39in | 31.20 | 196 | 420 | 70 | 610 |

¹ Actual total overall length of light fixture (LED strip + end caps + void/wire hole)

² Actual length of PCB strip

³ Actual length of 2x end caps

Standard End Caps (SB)

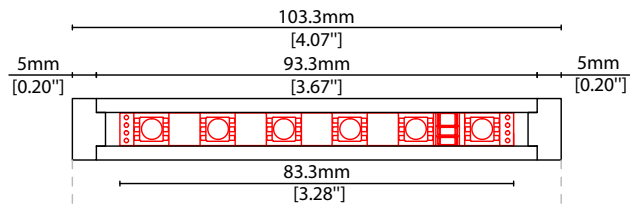

*Bracket End Caps (EB)
Increases overall standard length by 26mm (2x13mm)

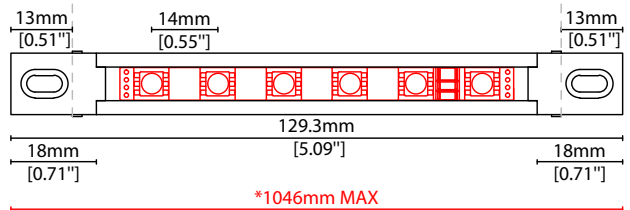

***IMPORTANT NOTE:**
DUE TO POTENTIAL PROFILE 'SAGGING' THE MAX LENGTH AVAILABLE WITH END CAP BRACKETS IS 1046mm.

COVER OPTIONS

* Options are an integral part of the fixture ordering codes. Please refer to **Code Table** pages.

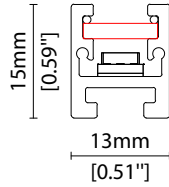

B Clear Cover
Polycarbonate
W13/H15mm (W0.51"/H0.59")

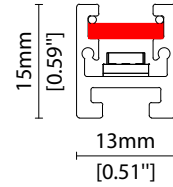

C Diffused Cover
Polycarbonate finish
W13/H15mm (W0.51"/H0.59")

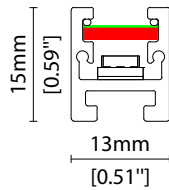
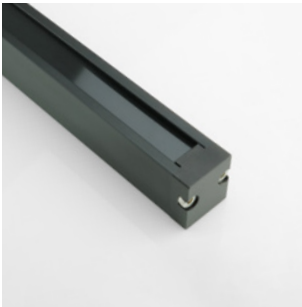

CN Diffused Cover + Nano Louvre
Polycarbonate cover with anti-glare, 30° cut-off view angle
W13/H15mm (W0.51"/H0.59")

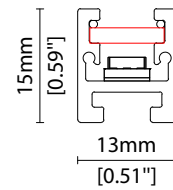

Y Black Clear Cover
Dark tinted translucent polycarbonate
60% light output
W13/H15mm (W0.51"/H0.59")

END CAP OPTION

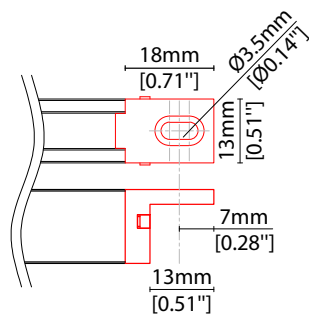

EB End Cap Bracket (Pair)
Handrail installation
Compatible up to 1m/40"
L18/W13/H15mm
(L0.7/W0.51/H0.59")

POWER FEED OPTIONS

* Options are an integral part of the fixture ordering codes. Please refer to **Code Table** pages.

0300 S00A 300mm (11.81") Single \varnothing 4.3mm sheath tail

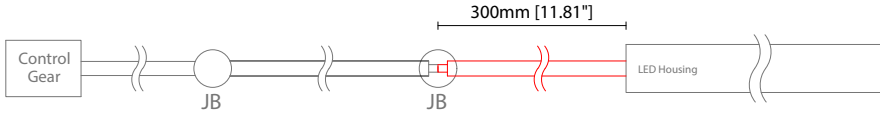

0300 D00A 300mm (11.81") Double \varnothing 4.3mm sheath tail

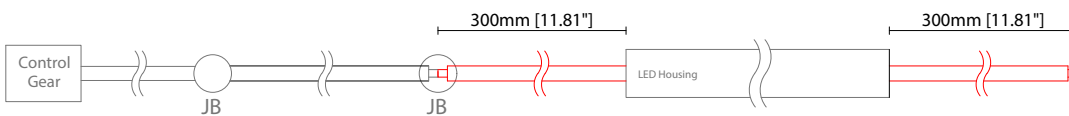

0300 S67A 300mm (11.81") Single \varnothing 4.3mm sheath IP67 connector

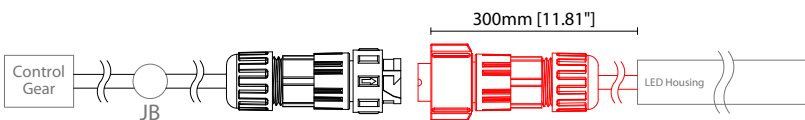

0300 D67A 300mm (11.81") Double \varnothing 4.3mm sheath IP67 connector

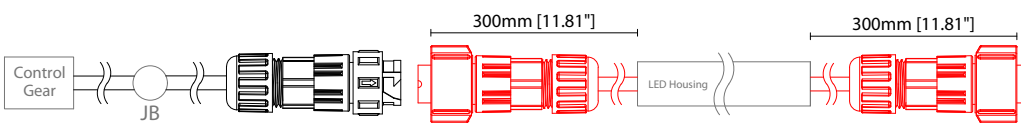

IP67 4 Pin Connector

Female connector
4 PIN (IP67)

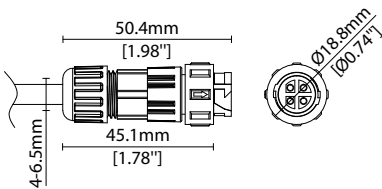

Male connector
4 PIN (IP67)

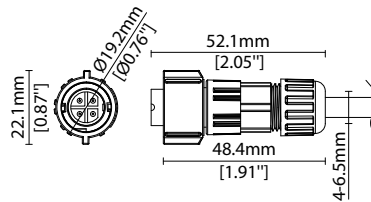

Key

Control Gear Power supply, sub-controllers & control systems

JB Junction box / cable connection

MOUNTING ACCESSORIES

Note: Accessories are to be ordered separately with corresponding code shown below.

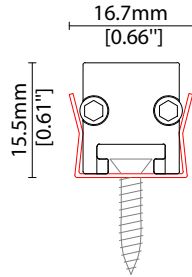

KKCP-02 (1no.)
KKCP-52 (500no.)
Clip (allow 3 per metre/40in)
S/Steel finish
L25/W16.7/H15.5mm
(L0.98/W0.66/H0.61")

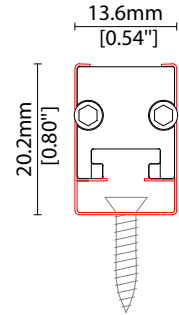

KKCP-14
Lock clip (allow 2 per metre/40in)
S/Steel finish
L25/W14/H21mm
(L0.98/W0.55/H0.83")

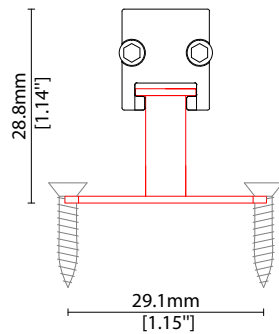

KKBK-06
Fixed bracket (allow 3 per metre/40in)
S/Steel finish
L20/W29.1/H28.8mm
L0.79/W1.15/H1.13"

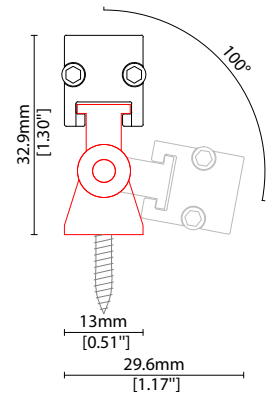

KKBK-05
Adjustable bracket
(allow 2 per metre/40in)
S/Steel finish
W13/H32.9mm
W0.51/H1.3"

POWER FEED

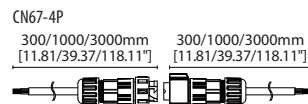

CN67-4P-0300 300mm (11.81in) pair
CN67-4P-1000 1000mm (39.37in) pair
CN67-4P-3000 3000mm (118.11in) pair

IP67
4 PIN male + female (RGB/LEDmix) connector set

EXTERIOR JUNCTION BOXES



KKJB-07

IP67 Slim J-Box
(including type A,B,C, D bushings)



KKJB-07R

Potting resin for IP67 Slim J-Box

KKDC CONTROL



IP20
Plastic housing
L170/W59/H29mm
(L6.69/W2.32/H1.14in)

KKDM-06 1-10V

visDIM dimmable sub-controller
(4 x 8A max @ 12-36V)



IP20
Plastic housing
L170/W53.4/H28mm
(L6.69/W2.10/H1.10in)

KKSC-05 DMX

visDIM dimmable sub-controller
(4 x 5A max @ 12-36V)



IP20
Plastic housing
L170/W59/H29mm
(L6.69/W2.32/H1.14in)

KKDL-02 DALI

visDIM dimmable sub-controller
(4 x 8A max @ 12-36V)



IP20
Plastic housing
L166/W53.4/H23mm
(L6.54/W2.10/H0.91in)

KKDL-03 DALI

visDIM dimmable sub-controller
(4 x 5A max @ 12-36V)

AVAILABLE PSU OPTIONS

| Control Mode | PSU (Order Code) | Input Voltage AC | Output Voltage DC | Rated Output Current | Rated Power | Dim % | IP Rating |
|---------------|------------------|------------------|-------------------|----------------------|-------------|-------------------|-----------|
| Switched | CEN-60-24 | 90-295V | 24V | 2.5A | 60W | - | IP67 |
| | HLG-60H-24 | 90-305V | 24V | 2.5A | 60W | - | IP67 |
| | HLG-100H-24 | 90-305V | 24V | 4.0A | 100W | - | IP67 |
| | HLG-150H-24 | 90-305V | 24V | 6.3A | 150W | - | IP67 |
| | HLG-240H-24 | 90-305V | 24V | 10A | 240W | - | IP67 |
| 0-10V (1-10V) | PWM-40-24 | 90-305V | 24V | 1.67A | 40W | 100-0.15 (100-10) | IP67 |
| | PWM-60-24 | 90-305V | 24V | 2.5A | 60W | 100-0.15 (100-10) | IP67 |
| | PWM-90-24 | 90-305V | 24V | 3.67A | 90W | 100-0.15 (100-10) | IP67 |
| | PWM-120-24 | 90-305V | 24V | 5.0A | 120W | 100-0.15 (100-10) | IP67 |
| DALI | LIN100A1 | 120-277V | 24V | 1A per channel | 100W | 100-0.1 | IP66/IP40 |
| DMX RGB | LIN100A1 | 120-277V | 24V | 1.33A per channel | 100W | 100-0.1 | IP66/IP40 |
| DMX RGBW | LIN100A1 | 120-277A | 24V | 1A per channel | 100W | 100-0.1 | IP66/IP40 |

Flicker Free Options - Combination of PSU+ sub-controller

| Control Mode | PSU (Order Code) | Sub-controller (Order Code) | Input Voltage AC | Output Voltage DC | Rated Output Current | Rated Power | Dim % | IP Rating PSU/ Sub-controller |
|----------------|------------------|-----------------------------|------------------|-------------------|----------------------|-------------|---------|-------------------------------|
| 0-10V or 1-10V | CEN-60-24 | KKDM-06 | 90-295V | 24V | 2.5A | 60W | 100-0.9 | IP67/IP20 |
| | HLG-60H-24 | KKDM-06 | 90-295V | 24V | 2.5A | 60W | 100-0.9 | IP67/IP20 |
| | HLG-100H-24 | KKDM-06 | 90-295V | 24V | 4.0A | 100W | 100-0.9 | IP67/IP20 |
| | HLG-150H-24 | KKDM-06 | 90-295V | 24V | 6.3A | 150W | 100-0.9 | IP67/IP20 |
| | HLG-240H-24 | KKDM-06 | 90-295V | 24V | 10.0A | 240W | 100-0.9 | IP67/IP20 |
| DALI | CEN-60-24 | KKDL-02/03 | 90-295V | 24V | 2.5A | 60W | 100-0.1 | IP67/IP20 |
| | HLG-60H-24 | KKDL-02/03 | 90-305V | 24V | 2.5A | 60W | 100-0.1 | IP67/IP20 |
| | HLG-100H-24 | KKDL-02/03 | 90-305V | 24V | 4.0A | 100W | 100-0.1 | IP67/IP20 |
| | HLG-150H-24 | KKDL-02/03 | 90-305V | 24V | 6.3A | 150W | 100-0.1 | IP67/IP20 |
| | HLG-240H-24 | KKDL-02/03 | 90-305V | 24V | 10.0A | 240W | 100-0.1 | IP67/IP20 |
| DMX RGB | CEN-60-24 | KKSC-05 | 90-295V | 24V | 2.5A | 60W | 100-0.9 | IP67/IP20 |
| | HLG-60H-24 | KKSC-05 | 90-305V | 24V | 2.5A | 60W | 100-0.9 | IP67/IP20 |
| | HLG-100H-24 | KKSC-05 | 90-305V | 24V | 4A | 100W | 100-0.9 | IP67/IP20 |
| | HLG-150H-24 | KKSC-05 | 90-305V | 24V | 6.3A | 150W | 100-0.9 | IP67/IP20 |
| | HLG-240H-24 | KKSC-05 | 90-305V | 24V | 10.0A | 240W | 100-0.9 | IP67/IP20 |

¹ The items shown above cover the most frequently used specification but does not exhaust the possible options

² PSU and/or driver can be chosen from the table, or KKDC may recommend the best option upon receipt of the controls requirement and installation environment

³ Electrical shop drawing will include detailed information of PSU and relevant control drivers

⁴ Cut sheets are available on the controls section of www.kkdc.lighting or upon request