

Linear

MoMo-L 512

Fixture Guide

KKDC

Indoor/Outdoor | Surface | Max output up to 1800lm/m (548lm/ft)

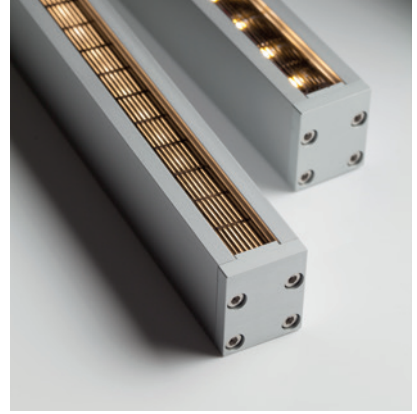

Key applications

- ✓ Bathrooms
- ✓ Building façades
- ✓ Ceiling
- ✓ Downlighting
- ✓ Interior/Exterior
- ✓ Public spaces
- ✓ Retail display
- ✓ Wall grazing
- ✓ Window Reveal

Key features

- ✓ Custom lengths
- ✓ Diffusion: Homogenous
- ✓ Direct view
- ✓ Extensive CCT range
- ✓ Form factor: Medium
- ✓ Glare Control
- ✓ IP54
- ✓ IP67
- ✓ Lensed
- ✓ Output max

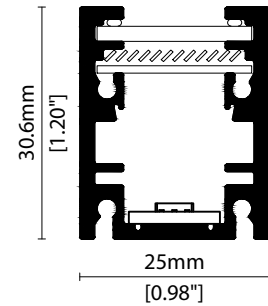

MOUNTING METHODS

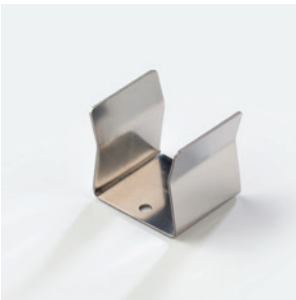

KKCP-03 Clip



KKCP-17 Lock clip



KKBK-07 Fixing plate



KKBK-21 Adjustable bracket

Linear

MoMo-L 512

Specification sheet



Dimension	H30/W25/L91.4-2020mm* (H1.18/W0.98/L3.60-79.53in*) *Nano Louvre = 1020mm/40.16in Max
PCB increment	71.4mm increment/2000mm* (2.81in increment/78.74in*) *Nano Louvre = 1000mm/39.37in Max
LED pitch	11.9mm - 84LED/m (0.47in - 26LED/ft)
Chip	s/e-line Toyoda Gosei k-line Toyoda Gosei or Equivalent
Beam angle	70° (Clear)/95° (Diffused)/35° (Diffused + Nano Louvre)
Colours	s/e-line 1900K/2100K/2300K/2500K/2700K/3000K/3500K/4000K/5000K k-line 1900K/2100K/2300K/2500K/2700K/3000K/3500K/4000K/5000K
Bin/Step	s-line 2-step MacAdam ellipse e/k-line 3-step MacAdam ellipse
CRI	≥ 90
Lifetime	50,000 hours @ 25°C (50,000 hours @ 77°F)
Operating temp	T _a = -20 to 40°C (T _c max = 62.6°C) T _a = -13 to 113°F (T _c max = 149°F)
IP rating	IP54/IP67
Finish	Silver anodised
Cover/lens	Clear/Clear + 23° (KKLN-03)/Clear + 23° (KKLN-03) + Micro Louvre/Clear + Micro Louvre/ Diffused/Diffused + Nano Louvre
Mounting	Surface mounting via clips or brackets
Power feed	Sheathed hardwire tails or male/female connectors
Control	0-10V/1-10V/DMX/DALI



LED Grading Key

Exclusive Grade

- s** s-line* 2-step CCT range *KKDC tuned CCT range
- e** e-line* 3-step CCT range

Base Grade

- k** k-line 3-step commercial range Energy Star CCTs

PERFORMANCE DATA @ 3000K

Power consumption	Supply voltage	Supply current
30.2W/m (9.2W/ft)	24V DC	1.26A/m (0.38A/ft)

Colour Rendering Index (CRI)

	R1	R2	R3	R4	R5	R6	R7	R8	R9	R10	R11	R12	R13	R14
k-line	94	97	98	93	93	96	92	83	60	93	94	82	95	99

	Clear	Clear + 23° (KKLN-03)	Clear + 23° (KKLN-03) + Micro Louvre	Clear + Micro Louvre	Diffused	Diffused + Nano Louvre	CRI	R9	Rf	Rg
s/e-line	1800lm/m (548lm/ft) 59.5lm/W	1006lm/m (307lm/ft) 33.3lm/W	483lm/m (147lm/ft) 16lm/W	700lm/m (213lm/ft) 23lm/W	760lm/m (230lm/ft) 25lm/W	192lm/m (58lm/ft) 6.3lm/W	91	55	-	-
k-line	1660lm/m (506lm/ft) 55lm/W	847lm/m (258lm/ft) 28.1lm/W	393lm/m (120lm/ft) 13lm/W	570lm/m (173lm/ft) 18.9lm/W	700lm/m (214lm/ft) 23.2lm/W	176lm/m (54lm/ft) 5.8lm/W	92	60	-	-

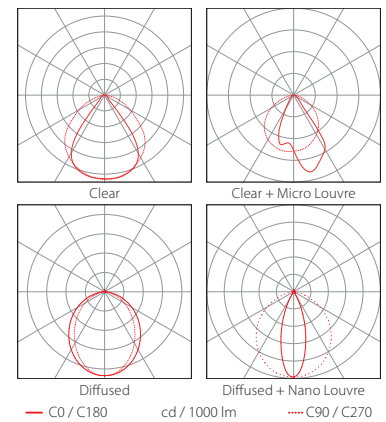
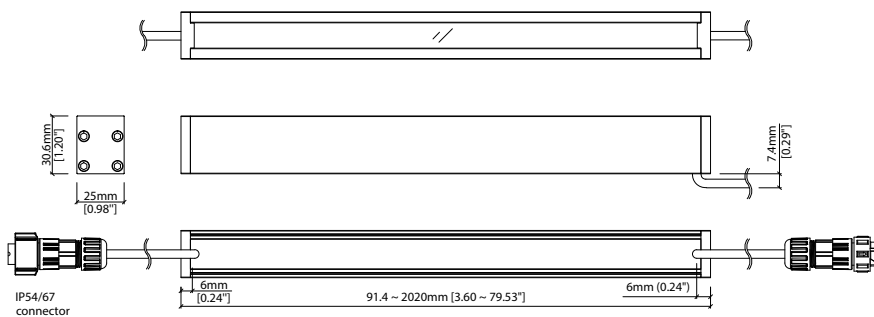

Data derived from independent UKAS/IESNA LM-79-08 accredited testing of production samples.

FIXTURE

Model	Finish	Cover/Lens ¹	Grade ²	LED	Colour (CCT)	Length Availability ³	IP	Cable Length	Power Feed ⁴	Input										
MoMo-L	MO	Silver Anodised	SA	Clear	B	s	s	512	1900K	19	m	91.4-2020mm 71.4mm increments	IP54	54	300mm/11.81"	0300	Single ø4.3mm sheath tail	S00A	DC 24V	g
					K	e	e	2100K	21											
					A	k	k	2300K	23											
								2500K	25											
					AK	k	k	2700K	27											
								3000K	30											
					C	k	k	3500K	35											
								4000K	40											
CN	k	k	5000K	50																

¹ Refer to **Cover/Lens Options** on **Options** pages ² Refer to **LED Grading Key** on **Specification sheet** page ³ Refer to **Length Availability List** or enter total run length instead of length code

⁴ Refer to **Power Feed Options** on **Options** pages ⁵ Max length available with Nano Louvre is 1020mm

⁶ Due to the clear, flush potted polyurethane top layer on IP67 MoMo-L a colour shift of +/- 20K should be expected

⁷ IP67 connectors are used for both IP67 and IP54 product housings

Code Example:

MO	-	SA	-	C	-	s	-	512	-	35	-	m	520	-	67	-	0300	-	D67A	-	g
MoMo-L		Silver Anodised		Diffused		s		512		3500K		m	519.8mm		IP67		300mm/11.81"		Double ø4.3mm sheath IP67 connector		DC 24V

ACCESSORIES

Mounting Accessories

KKCP-03	Clip (1no.)
KKCP-53	Clip (500no.)
KKCP-17	Lock Clip
KKBK-07	Fixing plate
KKBK-21	Adjustable bracket

* Refer to **Mounting accessories** on **Accessories** pages

Connection Accessories

CN67-2P-0300	IP67 2 PIN male & female 300mm/11.81" pair
CN67-2P-1000	IP67 2 PIN male & female 1000mm/39.37" pair
CN67-2P-3000	IP67 2 PIN male & female 3000mm/118.11" pair

* Refer to **Power feed** on **Accessories** pages

Exterior Junction Boxes

KKJB-07	IP67 Slim J-Box
KKJB-07R	Potting Resin for IP67 Slim J-Box

* Refer to **Exterior Junction Boxes** on **Accessories** pages

PSU/Driver

0-10V/1-10V/DALI/DMX

* Refer to **Driver/PSU Options** page for details or provide requirement and KKDC to offer the suitable option

LED ENGINE VARIANTS (LED STRIP TYPE)

Colour	Output	LED	Lumen/m	Lumen/ft	W/m	W/ft	Spec Doc	Length	Increment
Single CCT	Low	352	320	100	5.5	1.67	MoMo-L 352	103.3-2020mm (4.07-79.53in)	83.3mm (3.28in)
	Mid	504	760	232	12.5	3.81	MoMo-L 504	120-2020mm (4.72-79.53in)	100mm (3.94in)
	Mid	508	1040	317	17.5	5.33	MoMo-L 508	91.4-2020mm (3.60-79.53in)	71.4mm (2.81in)
	Max	512	1800	548	30.2	9.2	MoMo-L 512	91.4-2020mm (3.60-79.53in)	71.4mm (2.81in)
Warm Dim/Dynamic White	Max	040	3160	963	40	12.19	MoMo-L A040	97-1520mm (3.82-59.84in)	38.46mm (1.51in)
	Mid	207	570	171	11	3.35	MoMo-L 207	103.3-2020mm (4.07-79.53in)	83.3mm (3.28in)
	Mid	208	920	311	15.6	4.75	MoMo-L 208	186.7-2020mm (7.35-79.53in)	166.7mm (6.56in)
RGB		501	Red 95 Green 206 Blue 34 RGB 318	Red 29 Green 63 Blue 10 RGB 97	15.6	4.75	MoMo-L RGB	103.3-2020mm (4.07-79.53in)	83.3mm (3.28in)

* Performance data: A/s/e-line, clear cover, 3000K

MoMo-L 512

Length Availability List



Length Code		Fixture Length ¹		LED Strip ²		End Cap Dimension ³		Wattage (W)	Output (lm)	
Metric	Imperial(US)	Metric	Imperial(US)	Metric	Imperial(US)	Metric	Imperial(US)		3000K (Test Data)	Range Data
m0091	i0004	91mm	3.60in	71mm	2.81in	10mm	0.39in	2.16	129	10-176
m0163	i0006	163mm	6.41in	143mm	5.62in	10mm	0.39in	4.32	257	20-352
m0234	i0009	234mm	9.22in	214mm	8.44in	10mm	0.39in	6.48	386	30-528
m0306	i0012	306mm	12.04in	286mm	11.25in	10mm	0.39in	8.64	514	40-704
m0377	i0015	377mm	14.85in	357mm	14.06in	10mm	0.39in	10.80	643	50-879
m0448	i0018	449mm	17.66in	429mm	16.87in	10mm	0.39in	12.96	771	60-1055
m0520	i0020	520mm	20.47in	500mm	19.69in	10mm	0.39in	15.12	900	70-1231
m0591	i0023	591mm	23.29in	571mm	22.50in	10mm	0.39in	17.28	1028	80-1407
m0663	i0026	663mm	26.10in	643mm	25.31in	10mm	0.39in	19.44	1157	90-1583
m0734	i0029	734mm	28.91in	714mm	28.12in	10mm	0.39in	21.60	1285	100-1759
m0806	i0032	806mm	31.72in	786mm	30.93in	10mm	0.39in	23.76	1414	110-1935
m0877	i0035	877mm	34.53in	857mm	33.75in	10mm	0.39in	25.92	1542	120-2111
m0948	i0037	949mm	37.35in	929mm	36.56in	10mm	0.39in	28.08	1671	130-2287
m1020	i0040	1020mm	40.16in	1000mm	39.37in	10mm	0.39in	30.24	1799	140-2463
m1091	i0043	1091mm	42.97in	1071mm	42.18in	10mm	0.39in	32.40	1928	150-2638
m1163	i0046	1163mm	45.78in	1143mm	45.00in	10mm	0.39in	34.56	2056	160-2814
m1234	i0049	1234mm	48.59in	1214mm	47.81in	10mm	0.39in	36.72	2185	170-2990
m1306	i0051	1306mm	51.41in	1286mm	50.62in	10mm	0.39in	38.88	2313	180-3166
m1377	i0054	1377mm	54.22in	1357mm	53.43in	10mm	0.39in	41.04	2442	190-3342
m1448	i0057	1449mm	57.03in	1429mm	56.24in	10mm	0.39in	43.20	2570	200-3518
m1520	i0060	1520mm	59.84in	1500mm	59.06in	10mm	0.39in	45.36	2699	210-3694
m1591	i0063	1591mm	62.66in	1571mm	61.87in	10mm	0.39in	47.52	2827	220-3870
m1663	i0065	1663mm	65.47in	1643mm	64.68in	10mm	0.39in	49.68	2956	231-4046
m1734	i0068	1734mm	68.28in	1714mm	67.49in	10mm	0.39in	51.84	3084	241-4221
m1806	i0071	1806mm	71.09in	1786mm	70.31in	10mm	0.39in	54.00	3213	251-4397
m1877	i0074	1877mm	73.90in	1857mm	73.12in	10mm	0.39in	56.16	3342	261-4573
m1948	i0077	1949mm	76.72in	1929mm	75.93in	10mm	0.39in	58.32	3470	271-4749
m2020	i0080	2020mm	79.53in	2000mm	78.74in	10mm	0.39in	60.48	3599	281-4925

¹ Actual total overall length of light fixture (LED strip + end caps + void/wire hole)

² Actual length of PCB strip

³ Actual length of 2x end caps

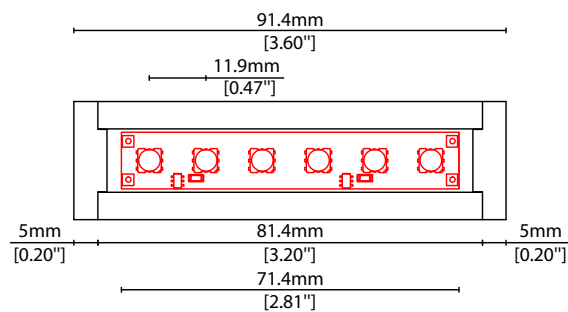

COVER/LENS OPTIONS

* Options are an integral part of the fixture ordering codes. Please refer to **Code Table** pages.

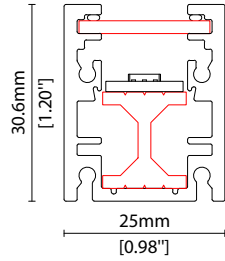

B Clear Cover

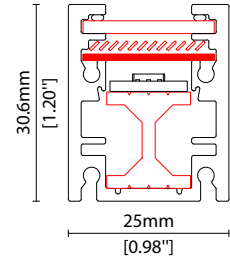
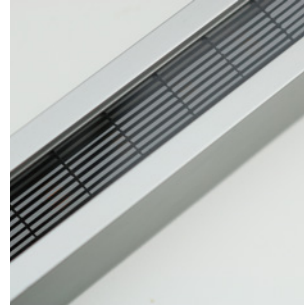

K Clear Cover + Micro Louvre
(diffused internal cover)

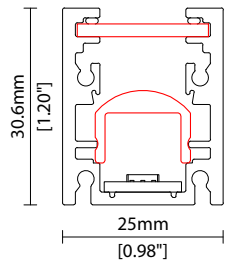
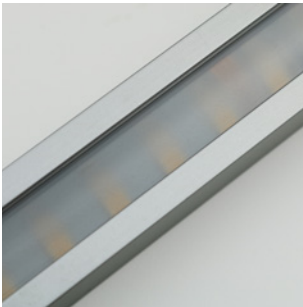

A Clear Cover +
23° (KKLN-03) lens

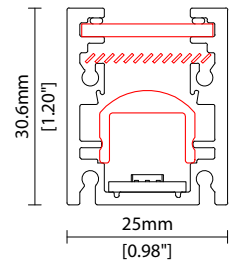
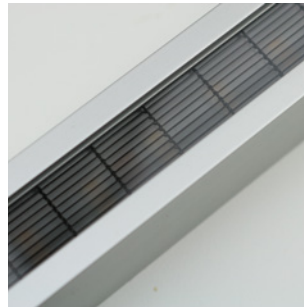

AK Clear Cover + 23° (KKLN-03)
lens + Micro Louvre

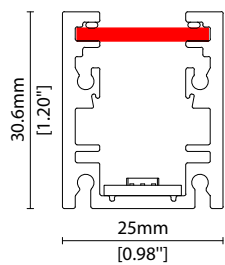

C Diffused Cover

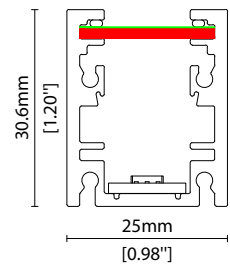
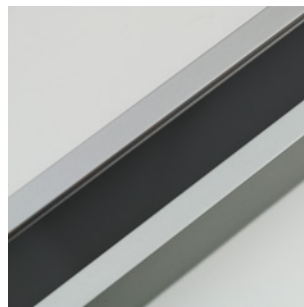

CN Diffused Cover + Nano Louvre

POWER FEED OPTIONS

* Options are an integral part of the fixture ordering codes. Please refer to **Code Table** pages.

0300 S00A 300mm (11.81") Single Ø4.3mm sheath tail

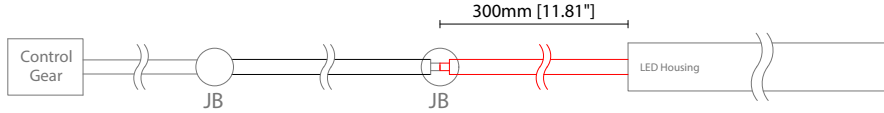

0300 D00A 300mm (11.81") Double Ø4.3mm sheath tail

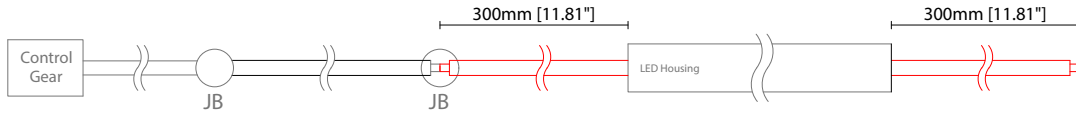

0300 S67A 300mm (11.81") Single ø4.3mm sheath IP67 connector

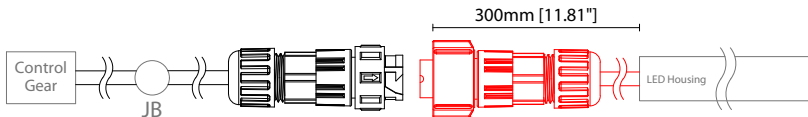

0300 D67A 300mm (11.81") Double ø4.3mm sheath IP67 connector

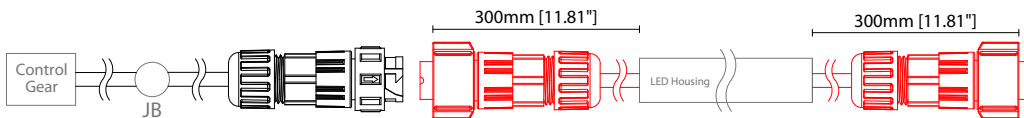

IP67 2 Pin Connector

Female connector
2 PIN (IP67)

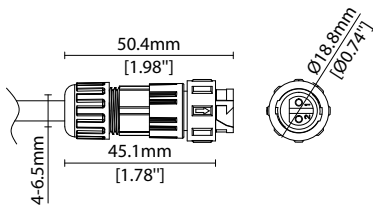

Male connector
2 PIN (IP67)

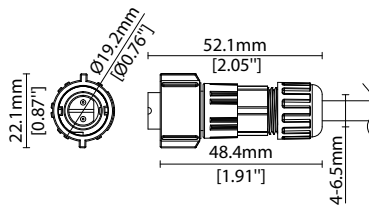

Key

- Control Gear Power supply, sub-controllers & control systems
- JB Junction box / cable connection

MOUNTING ACCESSORIES

Note: Accessories are to be ordered separately with corresponding code shown below.



KKCP-03 (1no.)
KKCP-53 (500no.)
Clip (allow 3 per metre/40in)
S/Steel finish
L25/W33.1/H33.5mm
(L0.98/W1.3/H1.32")

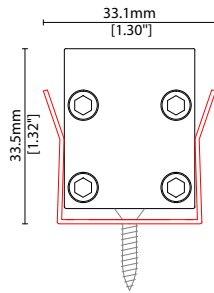

KKCP-17
Lock clip (allow 2 per metre/40in)
S/Steel finish
L25/W26.1/H45mm
(L0.98/W1.03/H1.77")

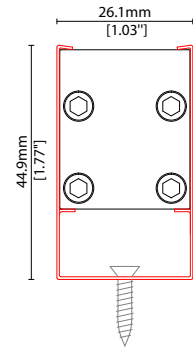

KKBK-07
Fixing plate (allow 2 per metre/40in)
Anodised aluminium finish
L50/W25/H38mm
(L1.97/W0.98/H1.5")
Pre-assembled in factory

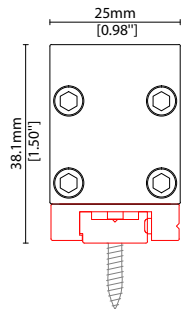

KKBK-21
Adjustable bracket
(allow 2 per metre/40in)
Anodised aluminium finish
L34/W25/H41.9mm
(L1.34/W0.98/H1.65")
Pre-assembled in factory

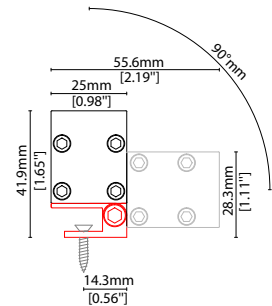

POWER FEED

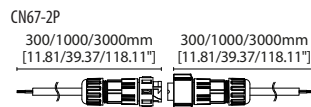

CN67-2P-0300 300mm (11.81in) pair
CN67-2P-1000 1000mm (39.37in) pair
CN67-2P-3000 3000mm (118.11in) pair
IP67
2 PIN male + female connector set

EXTERIOR JUNCTION BOXES



KKJB-07

IP67 Slim J-Box
(including type A,B,C,D bushings)



KKJB-07R

Potting resin for IP67 Slim J-Box

KKDC CONTROL



KKDM-06 1-10V

visDIM dimmable sub-controller
(4 x 8A max @ 12-36V)

IP20
Plastic housing
L170/W59/H29mm
(L6.69/W2.32/H1.14in)



KKSC-05 DMX

visDIM dimmable sub-controller
(4 x 5A max @ 12-36V)

IP20
Plastic housing
L170/W53.4/H28mm
(L6.69/W2.10/H1.10in)



KKDL-02 DALI

visDIM dimmable sub-controller
(4 x 8A max @ 12-36V)

IP20
Plastic housing
L170/W59/H29mm
(L6.69/W2.32/H1.14in)



KKDL-03 DALI

visDIM dimmable sub-controller
(4 x 5A max @ 12-36V)

IP20
Plastic housing
L166/W53.4/H23mm
(L6.54/W2.10/H0.91in)

AVAILABLE PSU OPTIONS

Control Mode	PSU (Order Code)	Input Voltage AC	Output Voltage DC	Rated Output Current	Rated Power	Dim %	IP Rating
Switched	CEN-60-24	90-295V	24V	2.5A	60W	-	IP67
	HLG-60H-24	90-305V	24V	2.5A	60W	-	IP67
	HLG-100H-24	90-305V	24V	4.0A	100W	-	IP67
	HLG-150H-24	90-305V	24V	6.3A	150W	-	IP67
	HLG-240H-24	90-305V	24V	10A	240W	-	IP67
0-10V (1-10V)	PWM-40-24	90-305V	24V	1.67A	40W	100-0.15 (100-10)	IP67
	PWM-60-24	90-305V	24V	2.5A	60W	100-0.15 (100-10)	IP67
	PWM-90-24	90-305V	24V	3.67A	90W	100-0.15 (100-10)	IP67
	PWM-120-24	90-305V	24V	5.0A	120W	100-0.15 (100-10)	IP67
DALI	LIN100A1	120-277V	24V	1A per channel	100W	100-0.1	IP66/IP40
DMX RGB	LIN100A1	120-277V	24V	1.33A per channel	100W	100-0.1	IP66/IP40
DMX RGBW	LIN100A1	120-277A	24V	1A per channel	100W	100-0.1	IP66/IP40

Flicker Free Options - Combination of PSU+ sub-controller

Control Mode	PSU (Order Code)	Sub-controller (Order Code)	Input Voltage AC	Output Voltage DC	Rated Output Current	Rated Power	Dim %	IP Rating PSU/ Sub-controller
0-10V or 1-10V	CEN-60-24	KKDM-06	90-295V	24V	2.5A	60W	100-0.9	IP67/IP20
	HLG-60H-24	KKDM-06	90-295V	24V	2.5A	60W	100-0.9	IP67/IP20
	HLG-100H-24	KKDM-06	90-295V	24V	4.0A	100W	100-0.9	IP67/IP20
	HLG-150H-24	KKDM-06	90-295V	24V	6.3A	150W	100-0.9	IP67/IP20
	HLG-240H-24	KKDM-06	90-295V	24V	10.0A	240W	100-0.9	IP67/IP20
DALI	CEN-60-24	KKDL-02/03	90-295V	24V	2.5A	60W	100-0.1	IP67/IP20
	HLG-60H-24	KKDL-02/03	90-305V	24V	2.5A	60W	100-0.1	IP67/IP20
	HLG-100H-24	KKDL-02/03	90-305V	24V	4.0A	100W	100-0.1	IP67/IP20
	HLG-150H-24	KKDL-02/03	90-305V	24V	6.3A	150W	100-0.1	IP67/IP20
	HLG-240H-24	KKDL-02/03	90-305V	24V	10.0A	240W	100-0.1	IP67/IP20
DMX RGB	CEN-60-24	KKSC-05	90-295V	24V	2.5A	60W	100-0.9	IP67/IP20
	HLG-60H-24	KKSC-05	90-305V	24V	2.5A	60W	100-0.9	IP67/IP20
	HLG-100H-24	KKSC-05	90-305V	24V	4A	100W	100-0.9	IP67/IP20
	HLG-150H-24	KKSC-05	90-305V	24V	6.3A	150W	100-0.9	IP67/IP20
	HLG-240H-24	KKSC-05	90-305V	24V	10.0A	240W	100-0.9	IP67/IP20

¹ The items shown above cover the most frequently used specification but does not exhaust the possible options

² PSU and/or driver can be chosen from the table, or KKDC may recommend the best option upon receipt of the controls requirement and installation environment

³ Electrical shop drawing will include detailed information of PSU and relevant control drivers

⁴ Cut sheets are available on the controls section of www.kkdc.lighting or upon request