

**HELIO Outdoor**  
**3-745-15**

oxygen

FIXTURE TYPE \_\_\_\_\_

LOCATION \_\_\_\_\_

PROJECT \_\_\_\_\_

DATE \_\_\_\_\_



-15 Black

**LIGHT SOURCE** 1 x 18W LED with Driver on board, 3000K, CRI 90

**LUMINAIRE POWER** 18.3W at 120V

**RATED LIFE** 50000 hr RL

**OPTIONAL COLOR TEMPERATURES** 3000K Only

**LUMEN OUTPUT** Delivered: 521 lm (LM-79)

**INPUT VOLTAGE** 120V AC, 50/60Hz

**DRIVER OUTPUT** N/A

**DIMMING** TRIAC Dimming

**CONSTRUCTION** Cast Aluminum Housing

**DIFFUSER** - Clear Glass with Painted White Interior

**FINISHES** Black (-15)

**MOUNTING** 4" Octagonal J-Box  
(Installer must provide a bead of caulk between fixture housing and mounting surface)

**STANDARDS** ETL Wet listed, ADA Compliant, Conforms to UL STD 1598, Certified CAN/CSA STD C22.2 No 250.0.

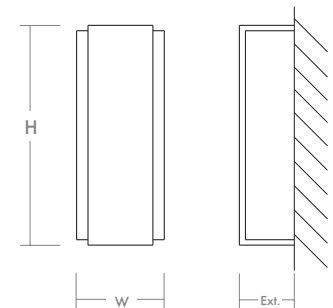
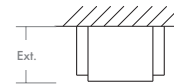

**DIMENSIONS**

**W:** 6.25"

**H:** 18.00"

**Ext:** 4.00"

**M.C:** 8.00" From top of fixture

Order example for standard fixture:

**3-745-15** (x- Voltage - xxx-Sequence # - xx-Finish)

3: 120V Only

