

HELIOS 2

2" Adjustable LED Fixture, 1000 Lumens, 13 Watts
Recessed Downlighting



Job Information	
Project Name	
Type	
Location	
Quantity	
Date	

Description

HELIOS allows one to take ultimate control over the optical performance of the fixture. Including onsite hot and cold aiming, horizontal light source adjustment, vertical height adjustment of light source, 360-degree rotation, changeable optics and layering of media. Get precise with tight beam angles down to 5 degrees. A perfect wall wash optic and goof-proof trimless options that prevents drywall errors. Feel confident using the HELIOS series in museums, art galleries, and theatres.

Technical Drawings

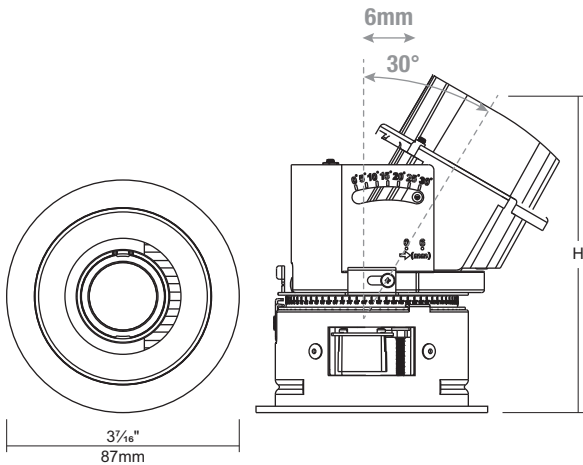

Height Position	Height (H)*
Position 1	4 1/4" (108mm)
Position 2	4 7/8" (124mm)
Position 3	5 9/16" (134mm)

* Dimension measured in vertical position, height may increase up to 4mm when angle is adjusted.



FIXTURE SPECIFICATIONS

Aperture	2 1/2" (64mm)
Approved Location	Dry
Certification	cETLus
CRI	80 / 90 / 95
Dimming	Yes
Hole Cut Size	Ø 3" (75mm)
Lumens per Watt	Typical 77
Lumen Maintenance	70% @ 50,000 Hrs
Max Ceiling Thickness	1" (25mm)
Max Mechanical Tilt	30°
Max Optical Tilt	20°
Power Factor	> 0.9
Power Supply Type	Constant Current
Rotation	365°
THD	<20%
TM-30 Annex E	P2 / V- / F1

Step 1 of 2: Light Fixture Ordering Guide

	Trimless Option	Delivered Lumens ¹	Color Temp.	Beam Angle	Media One	Media Two	Driver Options	Emergency Backup	Mounting	Shipping
H2	<input type="text"/>	<input type="text"/>	<input type="text"/>	<input type="text"/>	<input type="text"/>	<input type="text"/>	<input type="text"/>	<input type="text"/>	<input type="text"/>	<input type="text"/>
QUICKSHIP 7-DAY	T : Trim R : Round Trimless ³ Q : Square Trimless ³ C : Round Millwork ¹³ S : Square Millwork ¹³	10 : 1000 lm (13W)	27 : 2700 K (90+ CRI) 30 : 3000 K (90+ CRI) 35 : 3500 K (90+ CRI) 40 : 4000 K (90+ CRI) 50 : 5000 K (80+ CRI) 2H : 2700 K (95+ CRI) 3H : 3000 K (95+ CRI) DW : Dim-to-Warm (700lm 90+ CRI) ¹² WT : White Tunable (90+ CRI) ¹²	N : Narrow (28°) ⁹ D : Medium (36°) ⁶ (45°) M : Medium Flood (45°) W : Wide Flood (55°) ⁶ S : Spot (15°) ¹⁰ Z : Wall Wash ¹⁴	0 : No Media 1 : Honeycomb Louver 2 : Softening Lens 3 : Light Bending Lens (20°) 4 : Linear Spreading Lens 5 : Color Gel Lens	0 : No Media 3 : Light Bending Lens ² 4 : Linear Spreading Lens ² 5 : Color Gel Film ²	CX : TRIAC, ELV, 0-10V, 120-277V Input B3 : Rated -40°C, 0-10V, 347V Input ^{3,4} BX : Rated -40°C, 0-10V, 120-277V Input ^{3,4} DA : DALI, rated -40°C, 120-277V Input ³ D3 : DALI, rated -40°C, 347V Input ^{3,4} DX : DMX, 120-277V Input ³ LE : Lutron EcoSystem, 120-277V Input ³ QX : Casambi enabled driver, 120-277V & 347V Input ³	N : No Emergency Backup E : Emergency Backup, 0-10V, 90 min at 900lm (120-277V) ^{3,5}	RM : Remodel ⁷ NC : New Construction Hanger Bars AR : Architectural C-Channel Brackets IC : Type IC Box ⁸ CP : Chicago Plenum ⁹	1 : Ship Complete 2 : Ship Rough-in First ¹¹

Example housing items for "Ship Rough-in First":

First: H2T-1030N20CXN-NC2
Second: H2T-1030N202

Notes:

- Delivered lumens provided are based on 3000 K with narrow reflector.
- Media Two requires a selection from Media One and cannot be the same.
- Above ceiling access required.
- Additional Emergency Back-up not available.
- Emergency Back-up is rated only to 0°C.
- Must select softening lens as Media One.
- Remodel must ship complete.
- Only available with "CX" and "LE" driver.
- Required for wall wash trim.
- Spot beam angle available with driver CX/DX/QX only.
- Minimum order of 40 pieces to "Ship Rough-in First".
- Must select "D" or "W" Beam Angle.
- Compatible with 5/8" wooden ceiling.
- Must be paired with a Wall Wash trim/baffle, only available with No Media.

Quick Ship option is available on orders of 100 pieces or less,

and will ship within 7 business days. Options must be selected from Quick Ship section to qualify. For additional options please consult your A-Line representative. All trademarks are the property of their respective owners. Casambi is a trademark of Casambi Technologies. Due to our continued efforts to improve our products, product specifications are subject to change without notice.

Step 2 of 2: Trim/Baffle Ordering Guide

H2T - - - - -

Style **Shape** **Function** **Baffle Color** **Trim Color**

T: Trim **R**: Round **F**: Fixed **BK**: Black **BK**: Black
L: Trimless² **S**: Square **A**: Adjustable **WH**: White **WH**: White
W: Wall Wash¹ **SS**: Semi-Specular¹ **SP**: Specular **GD**: Gold **TL**: Trimless²
DS: Dark Specular **CC**: Custom Color (RAL#)

QUICKSHIP
7-DAY

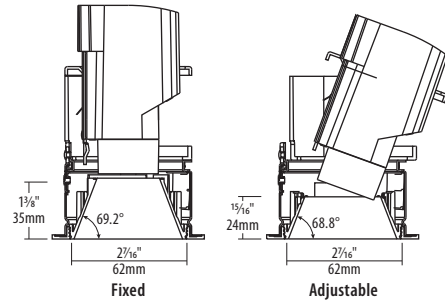

Example:
H2T-TR-ASPBK

Notes:

¹ Wall wash is only available in Semi-Specular and is to be selected with "Z" beam angle. Not available in square shape with trim (H2T-TS-xxxxx). ² Trimless has a baffle only, no trim. Quick Ship option is available on orders of 100 pieces or less, and will ship within 5 business days. Options must be selected from Quick Ship section to qualify.

Features

Housing

Painted steel carrier and collar are combined to hold and position die cast heat sink with integrated LED engine module and optics. Driver connection is made with FT6 plenum rated wire. Recessed mounting brackets adjust below the ceiling to secure the housing. Accommodates ceiling thicknesses from 3/4" (1mm) up to 1" (25mm).

Mounting

Options to configure for remodel, new construction, and architectural C-Channel mounting styles. An IC box is also available for both insulated ceilings and Chicago plenum applications tested in compliance with ASTM E283.

Hanger Bars – New Construction and IC Box

Rigid hanger bars extend up to 25" (635mm). Score lines on the hanger bars allow for tool-less shortening down to 12" (305mm). Built-in line-up foot allows for accurate housing height during installation. Integrated T-bar clips easily snap onto T-bars.

Hanger Bars – Architectural C-Channel

Architectural frame bracket accepts C-Channel and EMT conduit. Vertically adjustable.

System Protection

Integral thermal protection provided to indicate improper installations. Mounted in the heat sink and will disconnect if insulation is detected. Insulation must maintain 3" (76mm) clearance from top or sides.

Thermal Performance

Cast aluminum heat sink ensures optimal heat dissipation and LED life.

LED Optics

TIR lens for fixed CCT options, and a multifaceted reflector with integrated soft lens for Medium (36°) and Wide Flood (55°) beam angles. Optic holder can accommodate up to two additional optic media options. All beam angles other than spot are field exchangeable.

LED Characteristics

Fixed CCT high power Bridgelux® LED chips maintain uniform intensity with a typical 90 or 95 CRI. Dim-to-Warm (3000-1800K) and White Tunable (2700-5000K) are also available. White tunable requires an additional 0-10V signal to the driver to control CCT.

Optical Control

Mechanical tilt of 30°, optical tilt up to 20° with light bending lens, and rotation up to 365°. A horizontal drift of 6mm can be used to eliminate cut-off when

fixture is tilted. Tilt, drift and rotation are adjustable below the ceiling. Tilt angle can be factory set, and sprint tension will maintain angle through installation. The light source can be adjusted between three height settings to achieve max light output or max comfort for quiet ceilings.

Photometrics

See website or contact factory for IES files or additional photometry.

Trimless Option

Trimless adapter provides a flush and seamless ceiling mount. Trimless adapter is also available prefabricated in level 5 drywall for ease of installation.

LED Driver

Junction box mounted for ease of maintenance, the LED driver features a power factor larger than 0.9, and THD of less than 20%. Drivers are NEMA 410 compliant. See LED Driver Options for more specific details.

Junction Box

Listed for through branch circuit wiring. Maximum of six 12 AWG 90°C branch-circuit connections (three in and three out). Three knockouts available and compatible with Romex® cable clamp. Ground wire is provided on J-Box. Block connectors provided for

0-10V wiring.

Shipping

Fixtures can be shipped complete or with rough-in components first, and the remainder once requested. Drywall options ship separately.

Environment

Suitable for use in dry locations.

Warranty

7-Year warranty.

LED Driver Options

	Driver	Dimming Level	Controls	Notes
Fixed CCT	(CX) Standard	1%	TRIAC/ELV/0-10V	1% Only available in 0-10V, 10% otherwise
	(BX/B3) Rated -40°C	1%	0-10V	Low Temperature Driver
	(DA/D3) DALI	1%	DALI	Rated to -40°C
	(DX) DMX	0.10%	DMX/RDM	Rated to -40°C
	(LE) Lutron EcoSystem	1%	Lutron EcoSystem	Hi-lume 1% EcoSystem w/Soft-on, Fade-to-Black
	(PE) PoE	–	Constant Current	No Driver Provided
	(EX) Emergency Backup	1%	0-10V	90 min backup uptime at 900lm
Tunable White	(KX) Dual 0-10V	0.10%	Dual 0-10V	2 Channels isolated 0-10V control
	(TX) Lutron T-series	0.10%	T-series 2-channel	T-series 2-Channel Tunable White 1%
	(WX) OnCloud Enabled	1%	OnCloud Wi-Fi	OnCloud tunable white Wi-Fi control
	(QX) Casambi Enabled	1%	Casambi Bluetooth	Casambi Module included (CBU-ASR)

Accessories



HELIOS-EXT-10-3W

10' Flexible FT6 extension, for use with Helios fixtures.



HELIOS-EXT-50-3W

50' Flexible FT6 extension, for use with Helios fixtures.

Mounting: Remodel (Square)

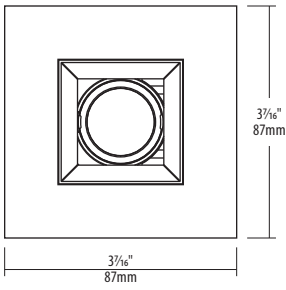

Mounting: IC BOX

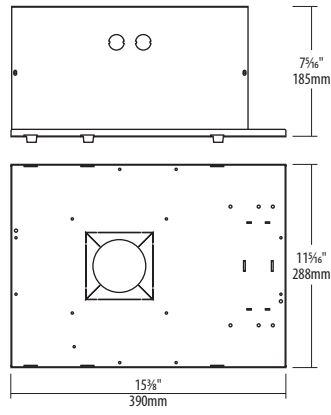

Mounting: New Construction

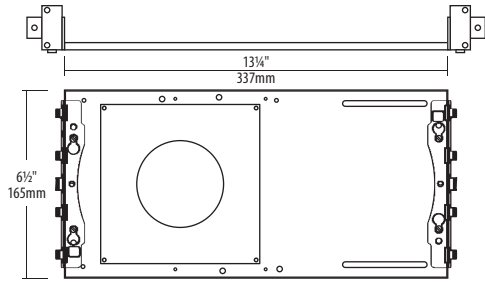

Mounting: Trimless Adapter in Drywall

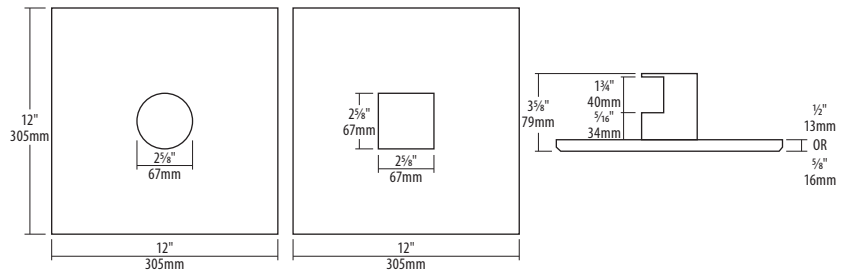

Mounting: Architectural C-Channel Brackets



Mounting: Trimless Adapter

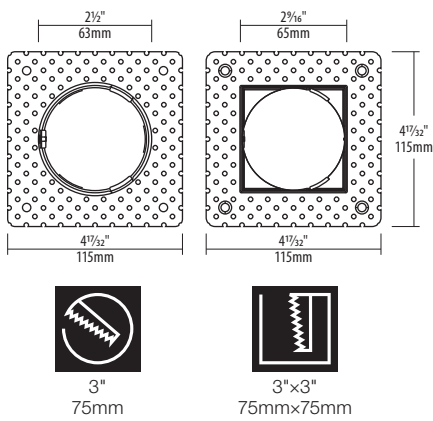

Mounting: Trimless for Millwork Adapter

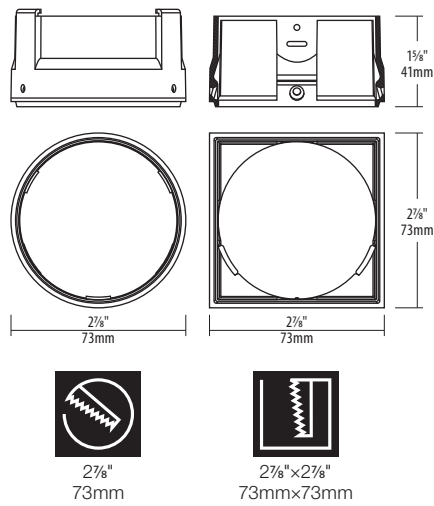

Photometry

CCT Correction Factors :

Baseline lumens = 3000 K

Multiply 3000 K lumen values by:

0.95 for 2700 K

1.10 for 3500 K

1.15 for 4000 K

1.20 for 5000 K

H2Q-1030W00xN-N-xxx + H2T-LS-WSSTL : HELIOS, 13W, wide flood beam spread, square wall wash semi-specular trim – Minimum height / No tilt

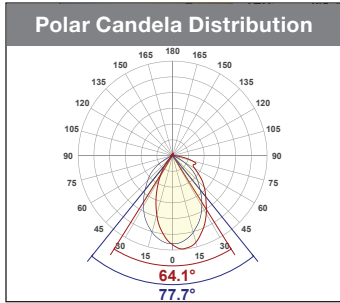

Beam Details				
D	Lux	FC	L	W
4'	187	17	5.6'	5.6'
8'	47	4	11.3'	11.3'
12'	21	2	16.9'	16.9'
16'	12	1	22.6'	22.6'
20'	7	1	28.2'	28.2'

Zonal Lumen Summary		
Zone	Lumens	% Luminaire
0-30	181	38.51%
0-40	267	56.81%
0-60	391	83.19%
60-90	58.2	12.38%
70-100	31.0	6.60%
90-120	9.92	2.11%
0-90	449	95.53%
90-180	20.5	4.36%
0-180	470	100%

H2x-1030D00xN-N-xxx + H2T-TR-FWHWH : HELIOS, 13W, medium beam spread, round fixed white trim – Minimum height / No tilt

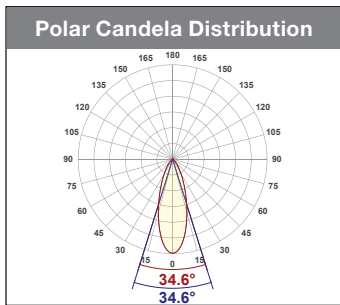

Beam Details				
D	Lux	FC	L	W
4'	1126	105	2.5'	2.5'
8'	282	26	5'	5'
12'	125	12	7.5'	7.5'
16'	70	7	10'	10'
20'	45	4	12.5'	12.5'

Zonal Lumen Summary		
Zone	Lumens	% Luminaire
0-30	623	72.53%
0-40	744	86.61%
0-60	810	94.30%
60-90	20.4	2.37%
70-100	16.9	1.97%
90-120	12.9	1.50%
0-90	831	96.74%
90-180	27.8	3.24%
0-180	859	100%

H2x-1030D00xN-N-xxx + H2T-TR-AWHWH : HELIOS, 13W, medium beam spread, round adjustable white trim – Minimum height / Maximum tilt / Maximum drift

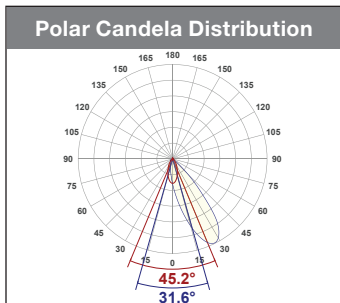

Beam Details				
D	Lux	FC	L	W
4'	298	28	2.9'	2.9'
8'	74	7	5.7'	5.7'
12'	33	3	8.6'	8.6'
16'	19	2	11.4'	11.4'
20'	12	1	14.3'	14.3'

Zonal Lumen Summary		
Zone	Lumens	% Luminaire
0-30	395	50.19%
0-40	603	76.62%
0-60	718	91.23%
60-90	41.5	5.27%
70-100	25.3	3.21%
90-120	13.0	1.65%
0-90	759	96.44%
90-180	28.0	3.56%
0-180	787	100%

H2x-1030M00xN-N-xxx + H2T-TR-FWHWH : HELIOS, 13W, medium flood beam spread, round fixed white trim – Minimum height / No tilt

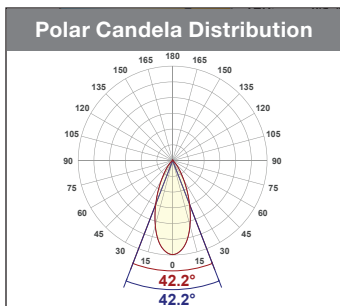

Beam Details				
D	Lux	FC	L	W
4'	1129	105	3.1'	3.1'
8'	282	26	6.2'	6.2'
12'	125	12	9.3'	9.3'
16'	71	7	12.4'	12.4'
20'	45	4	15.4'	15.4'

Zonal Lumen Summary		
Zone	Lumens	% Luminaire
0-30	765	74.63%
0-40	917	89.46%
0-60	978	95.41%
60-90	19.0	1.85%
70-100	16.6	1.62%
90-120	13.2	1.29%
0-90	997	97.27%
90-180	28.6	2.79%
0-180	1025	100%

H2x-1030M00xN-N-xxx + H2T-TR-AWHWH : HELIOS, 13W, medium flood beam spread, round adjustable white trim – Minimum height / Maximum tilt / Maximum drift

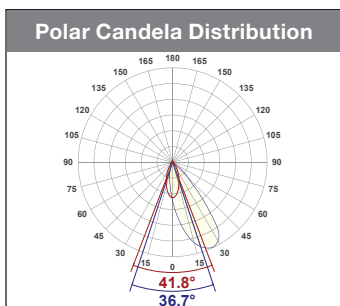

Beam Details				
D	Lux	FC	L	W
4'	442	41	2.9'	2.9'
8'	110	10	5.8'	5.8'
12'	49	5	8.7'	8.7'
16'	28	3	11.7'	11.7'
20'	18	2	14.6'	14.6'

Zonal Lumen Summary		
Zone	Lumens	% Luminaire
0-30	497	53.10%
0-40	732	78.21%
0-60	859	91.77%
60-90	48.6	5.19%
70-100	29.3	3.13%
90-120	13.2	1.41%
0-90	907	96.90%
90-180	28.9	3.09%
0-180	936	100%

H2x-1030N00xN-xxx + H2T-TR-FWHWH : HELIOS, 13W, narrow beam spread, round fixed white trim – Minimum height / No tilt

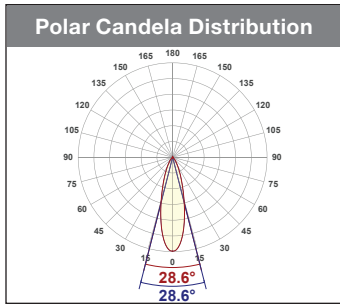

Beam Details				
D	Lux	FC	L	W
4'	1810	168	2'	2'
8'	453	42	4.1'	4.1'
12'	201	19	6.1'	6.1'
16'	113	11	8.1'	8.1'
20'	72	7	10.2'	10.2'

Zonal Lumen Summary		
Zone	Lumens	% Luminaire
0-30	787	79.25%
0-40	899	90.53%
0-60	948	95.47%
60-90	17.2	1.73%
70-100	14.6	1.47%
90-120	12.3	1.24%
0-90	966	97.28%
90-180	27.4	2.76%
0-180	993	100%

H2x-1030N00xN-xxx + H2T-TR-AWHWH : HELIOS, 13W, narrow beam spread, round adjustable white trim – Minimum height / Maximum tilt / Maximum drift

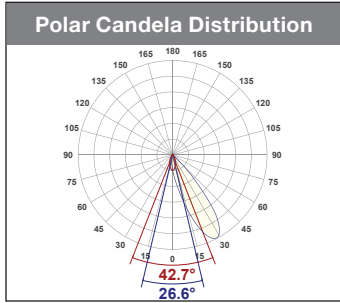

Beam Details				
D	Lux	FC	L	W
4'	302	28	2.6'	2.6'
8'	75	7	5.1'	5.1'
12'	34	3	7.7'	7.7'
16'	19	2	10.3'	10.3'
20'	12	1	12.8'	12.8'

Zonal Lumen Summary		
Zone	Lumens	% Luminaire
0-30	483	52.79%
0-40	742	81.09%
0-60	847	92.57%
60-90	40.7	4.45%
70-100	24.2	2.64%
90-120	12.4	1.36%
0-90	888	97.05%
90-180	26.5	2.90%
0-180	915	100%

H2x-1030N00xN-xxx + H2T-TR-FWHWH : HELIOS, 13W, narrow beam spread, round fixed white trim – Medium height / No tilt

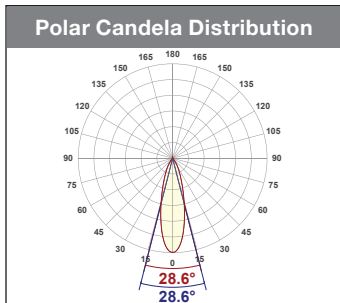

Beam Details				
D	Lux	FC	L	W
4'	1821	169	2'	2'
8'	455	42	4.1'	4.1'
12'	202	19	6.1'	6.1'
16'	114	11	8.2'	8.2'
20'	73	7	10.2'	10.2'

Zonal Lumen Summary		
Zone	Lumens	% Luminaire
0-30	794	81.52%
0-40	889	91.27%
0-60	922	94.66%
60-90	25.1	2.58%
70-100	18.2	1.87%
90-120	12.2	1.25%
0-90	947	97.23%
90-180	26.9	2.76%
0-180	974	100%

H2x-1030N00xN-xxx + H2T-TR-FWHWH : HELIOS, 13W, narrow beam spread, round fixed white trim – Maximum height / No tilt

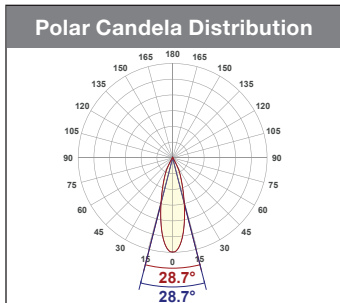

Beam Details				
D	Lux	FC	L	W
4'	1877	174	2'	2'
8'	469	44	4.1'	4.1'
12'	209	19	6.1'	6.1'
16'	117	11	8.2'	8.2'
20'	75	7	10.2'	10.2'

Zonal Lumen Summary		
Zone	Lumens	% Luminaire
0-30	811	85.46%
0-40	860	90.62%
0-60	896	94.42%
60-90	26.7	2.81%
70-100	18.5	1.95%
90-120	12.3	1.30%
0-90	923	97.26%
90-180	26.8	2.82%
0-180	949	100%

H2x-1030N30xN-xxx + H2T-TR-AWHWH : HELIOS, 13W, narrow beam spread, round adjustable white trim with light bending film – Minimum height / No tilt / Maximum drift

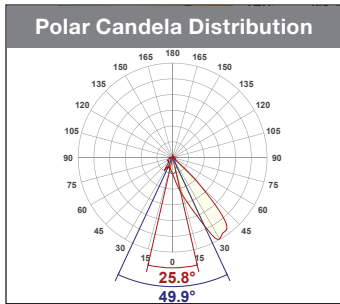

Beam Details				
D	Lux	FC	L	W
4'	107	10	2.9'	2.9'
8'	27	2	5.8'	5.8'
12'	12	1	8.7'	8.7'
16'	7	1	11.6'	11.6'
20'	4	0	14.6'	14.6'

Zonal Lumen Summary		
Zone	Lumens	% Luminaire
0-30	159	37.32%
0-40	276	64.79%
0-60	358	84.04%
60-90	46.1	10.82%
70-100	25.4	5.96%
90-120	10.5	2.46%
0-90	405	95.07%
90-180	21.6	5.07%
0-180	426	100%

H2x-1030S00xN-xxx + H2T-TR-FWHWH : HELIOS, 13W, spot beam spread, round fixed white trim – Minimum height / No tilt

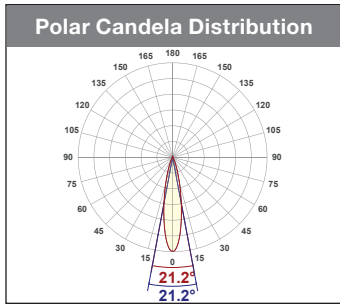

Beam Details				
D	Lux	FC	L	W
4'	1861	173	1.5'	1.5'
8'	465	43	3'	3'
12'	207	19	4.5'	4.5'
16'	116	11	6'	6'
20'	74	7	7.5'	7.5'

Zonal Lumen Summary		
Zone	Lumens	% Luminaire
0-30	490	84.34%
0-40	518	89.16%
0-60	540	92.94%
60-90	14.2	2.44%
70-100	13.6	2.34%
90-120	12.3	2.12%
0-90	554	95.35%
90-180	26.4	4.54%
0-180	581	100%

H2x-1030S00xN-xxx + H2T-TR-AWHWH : HELIOS, 13W, spot beam spread, round adjustable white trim – Minimum height / Maximum tilt / Maximum drift

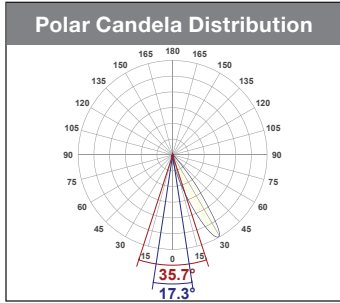

Beam Details				
D	Lux	FC	L	W
4'	87	8	2.1'	2.1'
8'	22	2	4.2'	4.2'
12'	10	1	6.3'	6.3'
16'	5	1	8.4'	8.4'
20'	3	0	10.5'	10.5'

Zonal Lumen Summary		
Zone	Lumens	% Luminaire
0-30	259	48.05%
0-40	431	79.96%
0-60	483	89.61%
60-90	30.5	5.66%
70-100	20.5	3.80%
90-120	12.3	2.28%
0-90	513	95.18%
90-180	25.8	4.79%
0-180	539	100%

H2x-1030W00xN-xxx + H2T-TR-FWHWH : HELIOS, 13W, wide flood beam spread, round fixed white trim – Minimum height / No tilt

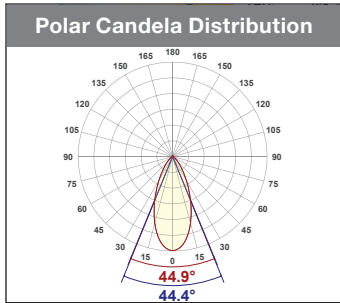

Beam Details				
D	Lux	FC	L	W
4'	804	75	3.3'	3.3'
8'	201	19	6.6'	6.6'
12'	89	8	9.8'	9.8'
16'	50	5	13.1'	13.1'
20'	32	3	16.4'	16.4'

Zonal Lumen Summary		
Zone	Lumens	% Luminaire
0-30	578	64.37%
0-40	723	80.51%
0-60	831	92.54%
60-90	29.4	3.27%
70-100	17.1	1.90%
90-120	14.0	1.56%
0-90	860	95.77%
90-180	37.7	4.20%
0-180	898	100%

H2x-1030W00xN-xxx + H2T-TR-AWHWH : HELIOS, 13W, wide flood beam spread, round adjustable white trim – Minimum height / Maximum tilt / Maximum drift

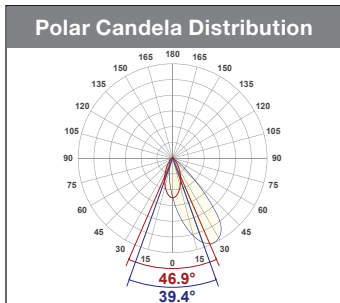

Beam Details				
D	Lux	FC	L	W
4'	366	34	3.2'	3.2'
8'	91	8	6.5'	6.5'
12'	41	4	9.7'	9.7'
16'	23	2	12.9'	12.9'
20'	15	1	16.1'	16.1'

Zonal Lumen Summary		
Zone	Lumens	% Luminaire
0-30	400	48.60%
0-40	610	74.12%
0-60	750	91.13%
60-90	44.6	5.42%
70-100	27.1	3.29%
90-120	13.1	1.59%
0-90	795	96.60%
90-180	28.4	3.45%
0-180	823	100%

H2x-1030W00xN-xxx + H2T-xR-WSSxx : HELIOS, 13W, wide flood beam spread, round wall wash semi-specular trim – Minimum height / No tilt

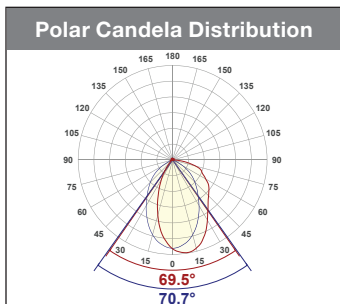

Beam Details				
D	Lux	FC	L	W
4'	185	17	5.5'	5.5'
8'	46	4	10.9'	10.9'
12'	21	2	16.4'	16.4'
16'	12	1	21.9'	21.9'
20'	7	1	27.3'	27.3'

Zonal Lumen Summary		
Zone	Lumens	% Luminaire
0-30	174	37.83%
0-40	254	55.22%
0-60	375	81.52%
60-90	64.2	13.96%
70-100	33.8	7.35%
90-120	9.69	2.11%
0-90	440	95.65%
90-180	20.1	4.37%
0-180	460	100%