

MXG2PSD

3.5" MX G2 LED Square Downlight Cylinder

JOB NAME		CATALOG NUMBER	
NOTES		TYPE	

ELECTRICAL DATA

LED Light Engine	System Wattage *	CCT / CRI	Nominal Delivered Lumens **
L0	10W	3000K / 82 CRI	850lm
L1	16W	3000K / 82 CRI	1200lm
L2	20W	3000K / 82 CRI	1400lm

* System Wattage include driver and LED Module consumption. / ** Delivered lumens will vary depending on CCT, CRI and optic selection

FEATURES

- Sleek, high performance pendant complements MX downlighting family
- Offered in various mounting options including cable, stem and surface
- Utilizes MX trims to ensure aesthetic consistency across the product line
- Unique flush, surface mount design allows for precise alignment and adjustment
- Dedicated 9° optic with field changeable 12°, 24°, 36° & 50° optics

LED LIGHT ENGINE

- 92 CRI & 82 CRI in 2700K, 3000K, 3500K and 4100K with 2 SDCM binning
- 50,000 hours L70 (rated life at 70% output)

ELECTRICAL SYSTEM

- 120/277V 50/60Hz input
- Class 2 power supply
- Over voltage/current and short circuit protection with auto recovery

REMOTE BOX

- Remote box included when required by specification
- Galvanized steel construction
- Separate line voltage and low voltage wiring compartments
- 50ft remote distance maximum

DIMMING

- Phase dimming: Forward 1% & Reversed 5% (120V only)
- 0-10V Dimming 1%
- eldoLED 0-10V 0.1% or 1%
- Lutron® LDE1 Hi-Lume 1% EcoSystem LED driver with Soft-on, Fade-to-Black dimming technology
- Lutron® LTEA2W Hi-lume 1% 2-wire LED driver (120V forward phase only)
- DMX512 RDM 0.1%

TRIM SPECIFICATION

High quality trims are die-cast using A380 aluminum with durable powder coat available in multiple finishes.

MOUNTING

- 9-inch model requires remote driver box for L2 lumen package
- 0-10V & Lutron EcoSystem options require remote driver box for cable mount option
- DMXR option requires remote driver box for cable and pendant mount options
- Cable / Pendant mount supplied with complete canopy assembly and matched to housing finish
- Cables mount option is adjustable in the field

ACCESSORIES

Luminaire will accommodate (2) accessories, accessory holder required. Accessory holder not compatible with lensed trims

LISTING / WARRANTY

- ETL Listed to US and Canadian standards for damp locations
- ETL Listed to US and Canadian standards for wet locations. Available with lensed surface mount options only.
- 5-Year Intense LED Limited Warranty



MX



Pendant Size Options

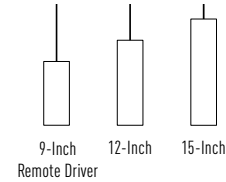

Dimensions see Page 2

Cylinder Part Number (Example: MXG2PSD2L13024WWR12)

Cylinder	Height	Wattage	CCT / CRI	Dimming (120-277V)
MXG2PSD	1 (9")	L0 (10 Watts)	27 (2700K / 82 CRI)	blank (Non-Dimming)
	2 (12")	L1 (16 Watts)	279 (2700K / 92 CRI)	DELV ² (Phase Dimming)
		L2 ¹ (20 Watts)	30 (3000K / 82 CRI)	D101 ³ (0-10V Dimming 1%)
	3 ⁶ (15")	L2 ¹ (20 Watts)	309 (3000K / 92 CRI)	ED10V1 ³ (eldoLED 0-10V 1%)
			35 (3500K / 82 CRI)	ED10V01 ³ (eldoLED 0-10V 0.1%)
		L2 ¹ (20 Watts)	359 (3500K / 92 CRI)	LUT ^{3,4} (Lutron® LDE1 EcoSystem 1%)
			41 (4100K / 82 CRI)	LUT2 ² (Lutron® LTEA2W 2-Wire 1%)
	419 (4100K / 92 CRI)	DMXR ⁵ (DMX512 RDM 0.1%)		

Optic	Housing Finish	Trim Finish	Lens	Mounting
09 ⁵ (9° Narrow Spot)	B (Black)	B (Black)	blank (None)	C48 (48" Cable)
12 (12° Spot)	W (White)	W (White)	SL ⁸ (Solite)	C96 (96" Cable)
24 (24° Narrow Flood)	SV (Silver)	SN (Satin Nickel)	CR ⁸ (Clear)	R12 (12" Rigid Pendant)
36 (36° Flood)		AB (Antique Bronze)	FR ⁸ (Frosted)	R18 (18" Rigid Pendant)
50 (50° Wide Flood)		WH (Wheat)		R24 (24" Rigid Pendant)
				R36 (36" Rigid Pendant)
				R48 (48" Rigid Pendant)
				S ⁷ (Surface)

Accessories

- LH47** (Accessory Holder, Black)
- LH47W** (Accessory Holder, White)
- PFLMB-47** (Hex Louver, Black)
- PFL1-47** (Prismatic Spread Lens)
- PFL2-47** (Linear Spread Lens)
- PFL4-47** (Solite Lens)

Notes:

1. Remote driver required for 9" with L2 Option
2. Available only in 120V
3. 0-10V & Lutron EcoSystem options require remote driver box for cable mount option
4. Not available in L2
5. Surface mount or remote driver box required, L2 & 279 only
6. Special order, consult factory for lead times
7. A lens option must be selected for wet location applications. Surface mount can be used in wet locations, see instruction sheet for proper installation instructions.
8. Accessories can not be used with lensed options

CYLINDERS-MX LUM-1012.22 P-5

Intense Lighting

3340 E La Palma Ave, Anaheim, CA 92806 | tel 714 630-9877 | fax 714 630-9883

©2022 Intense Lighting, LLC. All rights reserved. Subject to change without notice.

intense[®] | a LEVITON[®] company

MXG2PSD

3.5" MX G2 LED Square Downlight Cylinder

JOB NAME		CATALOG NUMBER	
NOTES		TYPE	

Surface Mount

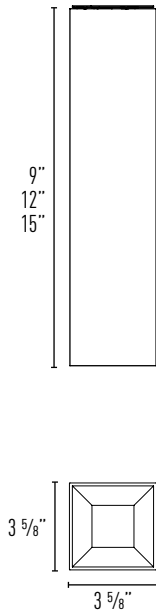

Rigid Pendant Mount

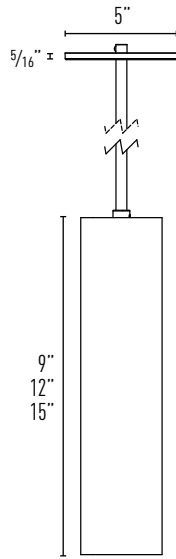

Remote Mounted driver options

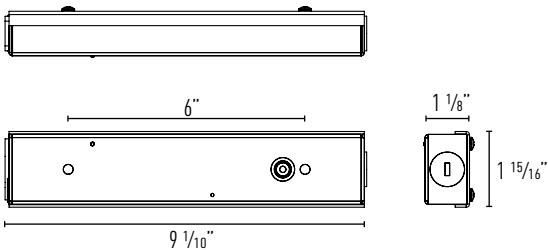

Remote Driver Box For

9-inch 0-10V Dimming 1%

12 & 15-inch 0-10V Dimming 1% (Cable)

Note: Wires for class 2 LED driver require a minimum of 18 AWG wire at a maximum of 50 feet length per local and national electrical regulations.

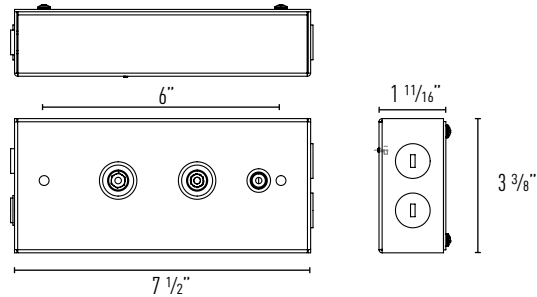

Remote Driver Box For

9-inch eldoLED 0-10V 1%
 eldoLED 0-10V 0.1%
 Lutron® LTEA2W 2-Wire 1%
 Lutron® LDE1 EcoSystem 1%
 DMX512 RDM 0.1%

12 & 15-inch eldoLED 0-10V 1% (Cable Only)
 eldoLED 0-10V 0.1% (Cable Only)
 Lutron® LDE1 EcoSystem 1% (Cable Only)
 DMX512 (Cable & Rigid Pendant)

Note: Wires for class 2 LED driver require a minimum of 18 AWG wire at a maximum of 50 feet length per local and national electrical regulations.

JOB NAME		CATALOG NUMBER	
NOTES		TYPE	

MXG2PSD3L030

Report #: ILL-20170428-04.001 (12)
 ILL-20170428-01.001 (24)
 ILL-20170428-02.001 (36)
 ILL-20170428-02.001 (50)

CCT MULTIPLIERS:

	82 CRI	92 CRI
2700K	(x 0.93)	(x 0.76)
3000K	(x 1.00)	(x 0.87)
3500K	(x 1.00)	(x 0.87)
4100K	(x 1.00)	(x 0.87)

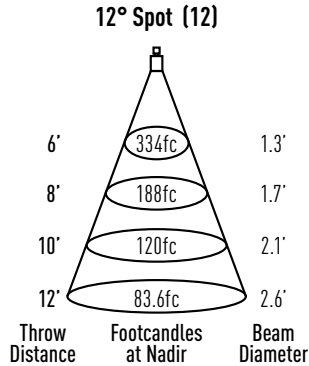

Watts: 10
 Lumens: 777
 LPW: 78
 CCT: 3000K

Candelas at Nadir

Degree	CBCP
0°	12039
5°	7471
15°	568
25°	88
35°	22
45°	3

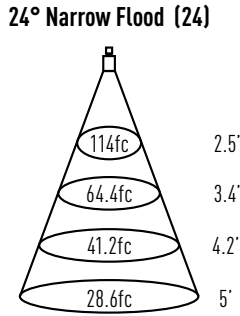

Watts: 10
 Lumens: 808
 LPW: 81
 CCT: 3000K

Candelas at Nadir

Degree	CBCP
0°	4121
5°	3702
15°	1314
25°	229
35°	12
45°	2

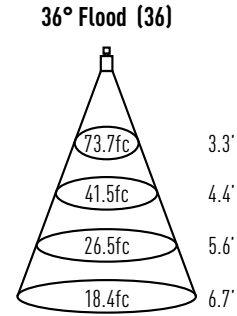

Watts: 10
 Lumens: 845
 LPW: 85
 CCT: 3000K

Candelas at Nadir

Degree	CBCP
0°	2654
5°	2530
15°	1399
25°	438
35°	39
45°	4

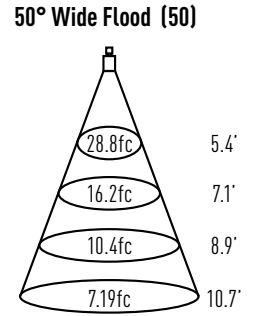

Watts: 10
 Lumens: 731
 LPW: 73
 CCT: 3000K

Candelas at Nadir

Degree	CBCP
0°	1038
5°	1020
15°	843
25°	520
35°	170
45°	43

MXG2PRD3L130

Report #: ILL-20170428-04.002 (12)
 ILL-20170428-01.002 (24)
 ILL-20170428-02.002 (36)
 ILL-20170428-05.002 (50)

CCT MULTIPLIERS:

	82 CRI	92 CRI
2700K	(x 0.93)	(x 0.76)
3000K	(x 1.00)	(x 0.87)
3500K	(x 1.00)	(x 0.87)
4100K	(x 1.00)	(x 0.87)

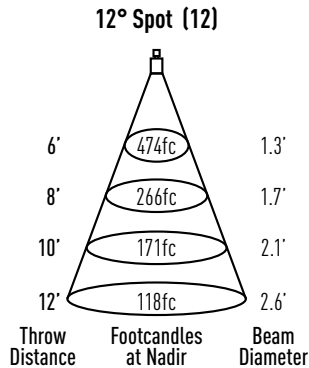

Watts: 16
 Lumens: 1101
 LPW: 69
 CCT: 3000K

Candelas at Nadir

Degree	CBCP
0°	17055
5°	10583
15°	805
25°	125
35°	31
45°	4

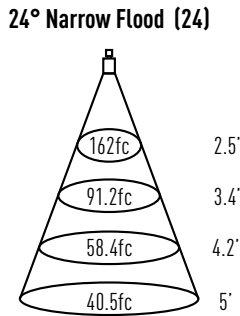

Watts: 16
 Lumens: 1144
 LPW: 72
 CCT: 3000K

Candelas at Nadir

Degree	CBCP
0°	5837
5°	5244
15°	1861
25°	324
35°	17
45°	2

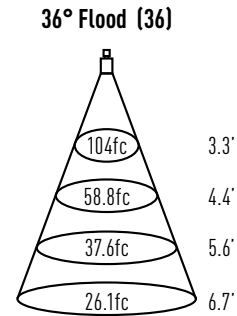

Watts: 16
 Lumens: 1197
 LPW: 75
 CCT: 3000K

Candelas at Nadir

Degree	CBCP
0°	3760
5°	3585
15°	1981
25°	621
35°	55
45°	6

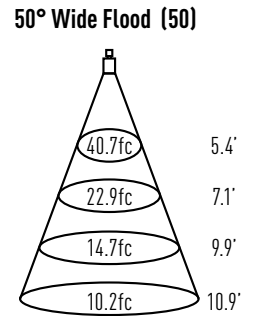

Watts: 16
 Lumens: 1035
 LPW: 65
 CCT: 3000K

Candelas at Nadir

Degree	CBCP
0°	1466
5°	1445
15°	1195
25°	737
35°	241
45°	62

JOB NAME		CATALOG NUMBER	
NOTES		TYPE	

MXG2PSD3L230

Report #:
 ILL-20170428-04.003 (12)
 ILL-20170428-01.003 (24)
 ILL-20170428-02.003 (36)
 ILL-20170428-05.0023(50)

CCT MULTIPLIERS:

	82 CRI	92 CRI
2700K	(x 0.93)	(x 0.76)
3000K	(x 1.00)	(x 0.87)
3500K	(x 1.00)	(x 0.87)
4100K	(x 1.00)	(x 0.87)

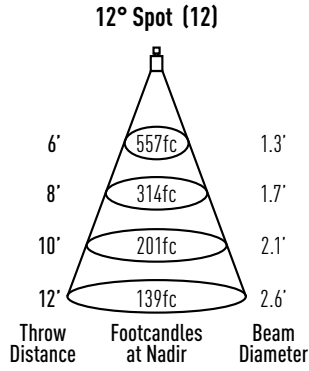

Watts: 20
 Lumens: 1295
 LPW: 65
 CCT: 3000K

Candelas at Nadir

Degree	CBCP
0°	20065
5°	12451
15°	947
25°	147
35°	36
45°	4

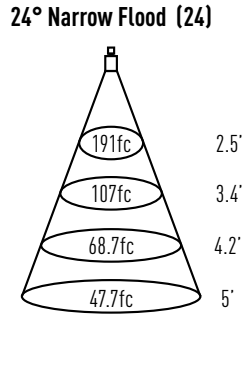

Watts: 20
 Lumens: 1346
 LPW: 67
 CCT: 3000K

Candelas at Nadir

Degree	CBCP
0°	6868
5°	6170
15°	2189
25°	382
35°	20
45°	3

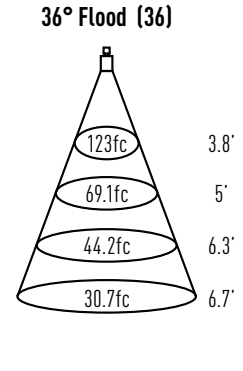

Watts: 20
 Lumens: 1407
 LPW: 70
 CCT: 3000K

Candelas at Nadir

Degree	CBCP
0°	4424
5°	4217
15°	2331
25°	731
35°	65
45°	7

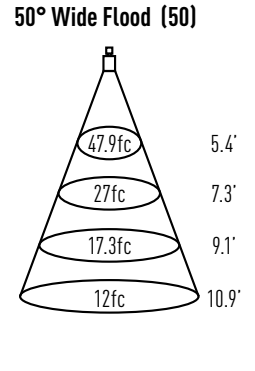

Watts: 20
 Lumens: 1218
 LPW: 61
 CCT: 3000K

Candelas at Nadir

Degree	CBCP
0°	1730
5°	1700
15°	1406
25°	867
35°	284
45°	72