

DATE: _____ PROJECT: _____ TYPE: _____

CATALOG NUMBER LOGIC:



CATALOG NUMBER LOGIC

Example: SN - 18 - C - MR - 359 - BLP - 9 - 11 - A - PC75-120

MATERIAL

Aluminum

SERIES

SN - Sign Star

STEM LENGTH

18" (Standard), 24", 30", 36", *42", or *48"

STYLE

C - Straight Mount

SOURCE

MR - MR16 Lamp**

LAMP TYPE

0 - MR16 HALOGEN LAMP (Furnished by others)

MR16 LED (This choice requires lamp number selection)***

FINISH

Standard Finishes (BZP, BZW, BLP, BLW, WHP, WHW, SAP, VER)

Premium Finish (ABP, AMG, AQW, BCM, BGE, BPP, CAP, CMG, CRI, CRM, HUG, MDS, NBP, OCP, RMG, SDS, SMG, TXF, WCP, WIR)

(Also available in RAL Finishes. See submittal SUB-1439-00)

LENS TYPE

9 - Clear (Standard)

10 - Spread 12 - Soft Focus 13 - Rectilinear

SHIELDING

11 - Honeycomb Baffle

CAP STYLE

A - 45°

B - 90°

C - Flush

D - 45° Less Weephole (Interior use only)

E - 90° Less Weephole (Interior use only)

F - 90° with Flush Lens

OPTIONS

PC75-120 - Power Canopy with 75VA Electronic 120V Transformer*

PC75-230 - Power Canopy with 75VA Electronic 230V Transformer*

PC75-277 - Power Canopy with 75VA Electronic 277V Transformer*

UPM - Universal Power Module

*36" maximum stem length with Power Canopy option.

**Designed for use with 12 VAC. LED transformer.

***Lamp details available on the next page.

DATE:

PROJECT:

TYPE:

CANOPY - SIDE VIEW

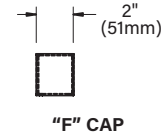
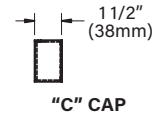
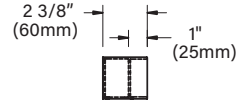
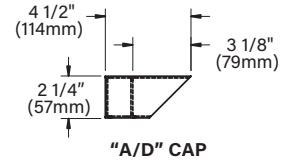
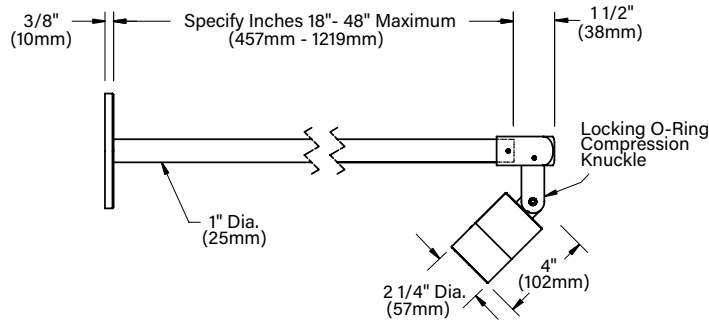

PC - SIDE VIEW

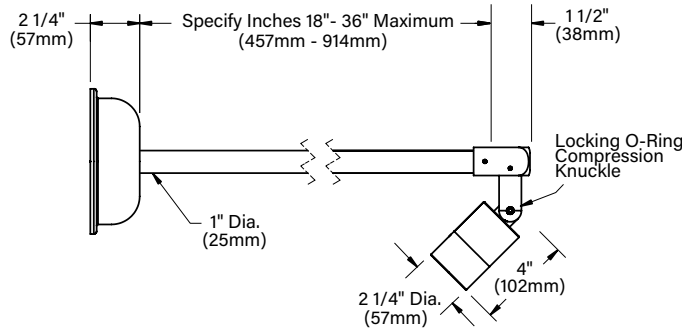

UPM - SIDE VIEW

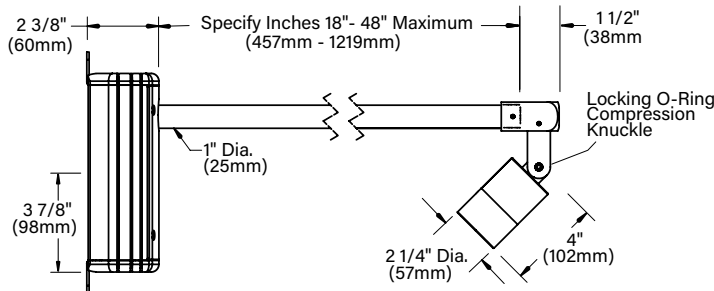

STANDARD FINISHES



PREMIUM FINISHES

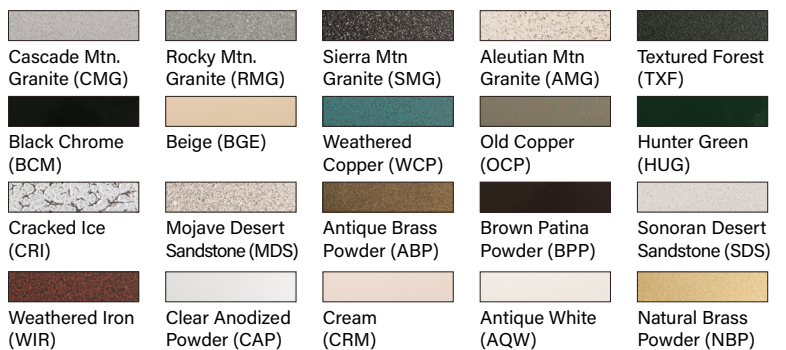





[Click Here](#) to view larger, full-color swatches of all available finishes on our website.

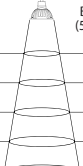

By SORAA™

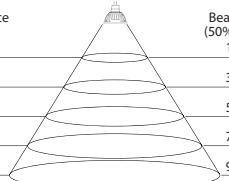
MR16 LED LAMP

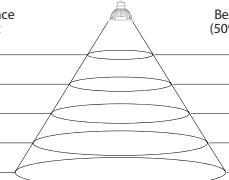
<p>B-K Lamp # 359 Base: GU5.3 Bi-Pin Input Voltage: 12V CCT: 2700K Beam: 10° Spot</p>	<p>Mfg. #: MR16- SM16-07-10D-827-H1 Wattage: 7.5W Lamp Efficacy: 77 (Lm/W) Rated Life: 35,000 hrs</p>	<p>CBCP (cd): 8000 CRI: >90 Power Factor: 0.92 Dimmable: Yes Lumens: 575</p>	 <table border="1"> <thead> <tr> <th>Distance feet</th> <th>Beam Dia. (50% CBCP)</th> <th>Footcandles</th> </tr> </thead> <tbody> <tr><td>3'</td><td>0.5'</td><td>634</td></tr> <tr><td>6'</td><td>1.0'</td><td>160</td></tr> <tr><td>9'</td><td>1.6'</td><td>69</td></tr> <tr><td>12'</td><td>2.1'</td><td>40</td></tr> <tr><td>15'</td><td>2.6'</td><td>23</td></tr> </tbody> </table>	Distance feet	Beam Dia. (50% CBCP)	Footcandles	3'	0.5'	634	6'	1.0'	160	9'	1.6'	69	12'	2.1'	40	15'	2.6'	23
Distance feet	Beam Dia. (50% CBCP)	Footcandles																			
3'	0.5'	634																			
6'	1.0'	160																			
9'	1.6'	69																			
12'	2.1'	40																			
15'	2.6'	23																			
<p>B-K Lamp # 361 Base: GU5.3 Bi-Pin Input Voltage: 12V CCT: 2700K Beam: 25° Narrow Flood</p>	<p>Mfg. #: MR16- SM16-07-25D-827-H1 Wattage: 7.5W Lamp Efficacy: 80 (Lm/W) Rated Life: 35,000 hrs</p>	<p>CBCP (cd): 3170 CRI: >90 Power Factor: 0.92 Dimmable: Yes Lumens: 600</p>	 <table border="1"> <thead> <tr> <th>Distance feet</th> <th>Beam Dia. (50% CBCP)</th> <th>Footcandles</th> </tr> </thead> <tbody> <tr><td>3'</td><td>1.3'</td><td>251</td></tr> <tr><td>6'</td><td>2.7'</td><td>63</td></tr> <tr><td>9'</td><td>4.0'</td><td>27</td></tr> <tr><td>12'</td><td>5.3'</td><td>16</td></tr> <tr><td>15'</td><td>6.7'</td><td>9</td></tr> </tbody> </table>	Distance feet	Beam Dia. (50% CBCP)	Footcandles	3'	1.3'	251	6'	2.7'	63	9'	4.0'	27	12'	5.3'	16	15'	6.7'	9
Distance feet	Beam Dia. (50% CBCP)	Footcandles																			
3'	1.3'	251																			
6'	2.7'	63																			
9'	4.0'	27																			
12'	5.3'	16																			
15'	6.7'	9																			
<p>B-K Lamp # 362 Base: GU5.3 Bi-Pin Input Voltage: 12V CCT: 2700K Beam: 36° Flood</p>	<p>Mfg. #: MR16- SM16-07-36D-827-H1 Wattage: 7.5W Lamp Efficacy: 80 (Lm/W) Rated Life: 35,000 hrs</p>	<p>CBCP (cd): 1550 CRI: >90 Power Factor: 0.92 Dimmable: Yes Lumens: 600</p>	 <table border="1"> <thead> <tr> <th>Distance feet</th> <th>Beam Dia. (50% CBCP)</th> <th>Footcandles</th> </tr> </thead> <tbody> <tr><td>3'</td><td>1.9'</td><td>119</td></tr> <tr><td>6'</td><td>3.9'</td><td>30</td></tr> <tr><td>9'</td><td>5.8'</td><td>13</td></tr> <tr><td>12'</td><td>7.8'</td><td>7</td></tr> <tr><td>15'</td><td>9.7'</td><td>4</td></tr> </tbody> </table>	Distance feet	Beam Dia. (50% CBCP)	Footcandles	3'	1.9'	119	6'	3.9'	30	9'	5.8'	13	12'	7.8'	7	15'	9.7'	4
Distance feet	Beam Dia. (50% CBCP)	Footcandles																			
3'	1.9'	119																			
6'	3.9'	30																			
9'	5.8'	13																			
12'	7.8'	7																			
15'	9.7'	4																			
<p>B-K Lamp # 363 Base: GU5.3 Bi-Pin Input Voltage: 12V CCT: 3000K Beam: 10° Spot</p>	<p>Mfg. #: MR16- SM16-07-10D-830-H1 Wattage: 7.5W Lamp Efficacy: 80 (Lm/W) Rated Life: 35,000 hrs</p>	<p>CBCP (cd): 8400 CRI: >90 Power Factor: 0.92 Dimmable: Yes Lumens: 600</p>	 <table border="1"> <thead> <tr> <th>Distance feet</th> <th>Beam Dia. (50% CBCP)</th> <th>Footcandles</th> </tr> </thead> <tbody> <tr><td>3'</td><td>0.5'</td><td>666</td></tr> <tr><td>6'</td><td>1.0'</td><td>168</td></tr> <tr><td>9'</td><td>1.6'</td><td>72</td></tr> <tr><td>12'</td><td>2.1'</td><td>42</td></tr> <tr><td>15'</td><td>2.6'</td><td>24</td></tr> </tbody> </table>	Distance feet	Beam Dia. (50% CBCP)	Footcandles	3'	0.5'	666	6'	1.0'	168	9'	1.6'	72	12'	2.1'	42	15'	2.6'	24
Distance feet	Beam Dia. (50% CBCP)	Footcandles																			
3'	0.5'	666																			
6'	1.0'	168																			
9'	1.6'	72																			
12'	2.1'	42																			
15'	2.6'	24																			
<p>B-K Lamp # 365 Base: GU5.3 Bi-Pin Input Voltage: 12V CCT: 3000K Beam: 25° Narrow Flood</p>	<p>Mfg. #: MR16- SM16-07-25D-830-H1 Wattage: 7.5W Lamp Efficacy: 84 (Lm/W) Rated Life: 35,000 hrs</p>	<p>CBCP (cd): 3300 CRI: >90 Power Factor: 0.92 Dimmable: Yes Lumens: 630</p>	 <table border="1"> <thead> <tr> <th>Distance feet</th> <th>Beam Dia. (50% CBCP)</th> <th>Footcandles</th> </tr> </thead> <tbody> <tr><td>3'</td><td>1.3'</td><td>266</td></tr> <tr><td>6'</td><td>2.7'</td><td>67</td></tr> <tr><td>9'</td><td>4.0'</td><td>29</td></tr> <tr><td>12'</td><td>5.3'</td><td>17</td></tr> <tr><td>15'</td><td>6.7'</td><td>10</td></tr> </tbody> </table>	Distance feet	Beam Dia. (50% CBCP)	Footcandles	3'	1.3'	266	6'	2.7'	67	9'	4.0'	29	12'	5.3'	17	15'	6.7'	10
Distance feet	Beam Dia. (50% CBCP)	Footcandles																			
3'	1.3'	266																			
6'	2.7'	67																			
9'	4.0'	29																			
12'	5.3'	17																			
15'	6.7'	10																			
<p>B-K Lamp # 366 Base: GU5.3 Bi-Pin Input Voltage: 12V CCT: 3000K Beam: 36° Flood</p>	<p>Mfg. #: MR16- SM16-07-36D-830-H1 Wattage: 7.5W Lamp Efficacy: 84 (Lm/W) Rated Life: 35,000 hrs</p>	<p>CBCP (cd): 1650 CRI: >90 Power Factor: 0.92 Dimmable: Yes Lumens: 630</p>	 <table border="1"> <thead> <tr> <th>Distance feet</th> <th>Beam Dia. (50% CBCP)</th> <th>Footcandles</th> </tr> </thead> <tbody> <tr><td>3'</td><td>1.9'</td><td>125</td></tr> <tr><td>6'</td><td>3.9'</td><td>32</td></tr> <tr><td>9'</td><td>5.8'</td><td>14</td></tr> <tr><td>12'</td><td>7.8'</td><td>8</td></tr> <tr><td>15'</td><td>9.7'</td><td>5</td></tr> </tbody> </table>	Distance feet	Beam Dia. (50% CBCP)	Footcandles	3'	1.9'	125	6'	3.9'	32	9'	5.8'	14	12'	7.8'	8	15'	9.7'	5
Distance feet	Beam Dia. (50% CBCP)	Footcandles																			
3'	1.9'	125																			
6'	3.9'	32																			
9'	5.8'	14																			
12'	7.8'	8																			
15'	9.7'	5																			

B-K LIGHTING

MADE IN THE USA

559.438.5800 | INFO@BKLIGHTING.COM | BKLIGHTING.COM

THIS DOCUMENT CONTAINS PROPRIETARY INFORMATION OF B-K LIGHTING, INC. AND ITS RECEIPT OR POSSESSION DOES NOT CONVEY ANY RIGHTS TO REPRODUCE, DISCLOSE ITS CONTENTS, OR TO MANUFACTURE, USE OR SELL ANYTHING IT MAY DESCRIBE. REPRODUCTION, DISCLOSURE OR USE WITHOUT SPECIFIC WRITTEN AUTHORIZATION OF B-K LIGHTING, INC. IS STRICTLY FORBIDDEN.

DATE: _____ PROJECT: _____ TYPE: _____

ACCESSORIES (Configure separately)

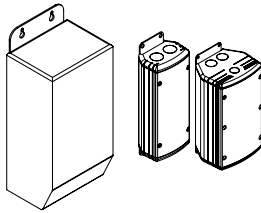

TR Series

UPMRM

SPECIFICATIONS

ELECTRICAL	<p>WATTAGE WIRING REMOTE TRANSFORMER</p>	<p>50W MAX PVC coated, 18AWG, 150V, 60°C rated and certified to UL 1838 standard. For use with 12VAC remote transformer.</p>
PHYSICAL	<p>MATERIALS STYLE BODY KNUCKLE CAP STEM LENS LAMP INSTALLATION HARDWARE FINISH WARRANTY CERTIFICATION & LISTING</p>	<p>Furnished in copper-free aluminum (6061-T6). C style features straight profile with machined adapter for 90° transition from fixture to stem. Unibody design is fully machined from solid billet and provides enclosed, water-proof wireway and integral heat sink for maximum component life. Integral knuckle for maximum mechanical strength. High temperature, silicone 'O' Ring provides water-tight seal. LOCK Knuckle is integral to the body and features an interior taper machined from solid billet and a second, reverse angle taper allowing full 180° vertical adjustment without the use of aim-limiting serrated teeth. High temperature, silicone 'O' Ring provides water-tight seal and compressive resistance to maintain fixture position. Design withstands 73 lbs. static load prior to movement for optical alignment with a ½" pipe thread for mounting. Fully machined and accommodates two (2) lens or louver media. Fully machined, 1" dia. with internal threads for maximum visual appeal. Available in configurable lengths to 48" maximum. Shock-resistant, tempered glass lens is factory adhered to fixture cap and provides hermetically sealed optical compartment. For use with 50W maximum, MR16 lamp.* Not for use with IR technology lamps. Halogen sourced by others. *Except GE Light Q42MR16/C/VNSP9 (EZY). 5" dia., machined canopy permits mounting to 4" octagonal junction box. Junction box installation must be designed to hold full fulcrum weight of fixture (junction box and gasket by others). Tamper-resistant, stainless steel hardware. LOCK aiming screw and canopy mounting screws are black oxide treated for additional corrosion resistance. StarGuard, our 15-stage chromate-free process cleans and conversion coats aluminum components prior to application of Class 'A' TGIC polyester powder coating and is RoHS compliant. Powder coat or metal finish options available for brass material and metal finish option only for stainless steel material. 5-year limited warranty. UL tested to IESNA LM-79. UL listed. Certified to CAN/CSA/ANSI standards. RoHS compliant. Suitable for indoor or outdoor use, in wet locations, and for installation within 4' of the ground. IP66 Rated. Made in the USA with sustainable materials.</p>

