

CTL800

18W and 27W LED Cylinder Track Fixture

Specifications/Features

Fixture

18W and 27W high performance, dimmable LED track fixture. Sleek, cylindrical shape with integral driver housing. Decorative extruded aluminum heat sink with vertically oriented fins for optimal heat dissipation. LEDs are available in spot, medium or flood beam distributions and three color temperatures: 2700K, 3000K and 3500K. Standard dimming driver provides smooth, flicker free dimming down to 10%. Lockable, precision aiming. Fixtures features 350° horizontal rotation and 180° vertical lockable, aiming adjustment. ConTech track adapter with polarity indicator and integral ON/OFF switch is standard. Includes 1/2" snoot for glare control and as an accessory holder. Will accept one (1) LF18 lens or louver.

Lamp

LED light engine consists of seven (7) high brightness LEDs with highly efficient, individual TIR optics providing consistent, uniform beam distributions. System designed and rated for 50,000 hours at 70% lumen maintenance. Color Temperature: 2700K (2725 ± 145)
3000K (3045 ± 175)
3500K (3465 ± 245)

Electrical

18W Dimming Driver Specifications: Input Voltage: 90-135VAC, 47-63Hz
Input Current: <0.30A @ 120VAC
27W Dimming Driver Specifications: Input Voltage: 110-220VAC, 47-63Hz
Input Current: 0.30A @ 120VAC,
0.15A @ 220VAC

Warranty

This complete fixture is covered by ConTech's full five (5) year replacement guarantee after date of purchase.

Listing

cCSAus Certified to UL Standards. Suitable for dry locations.

Fixture Compatibility

Standard ConTech track fixtures are cCSAus Certified as-is for use with ConTech's many track systems, as well as with Juno^{®1} Lighting track. By changing the prefix in the part number, ConTech can install inserts which make our fixtures compatible with other manufacturers. Replace "CTL" with "HTL" for Halo^{®2} track, "LTL" for Lightolier^{®3} track, and "PTL" for Capri^{®4} track. For more information, please consult our factory.

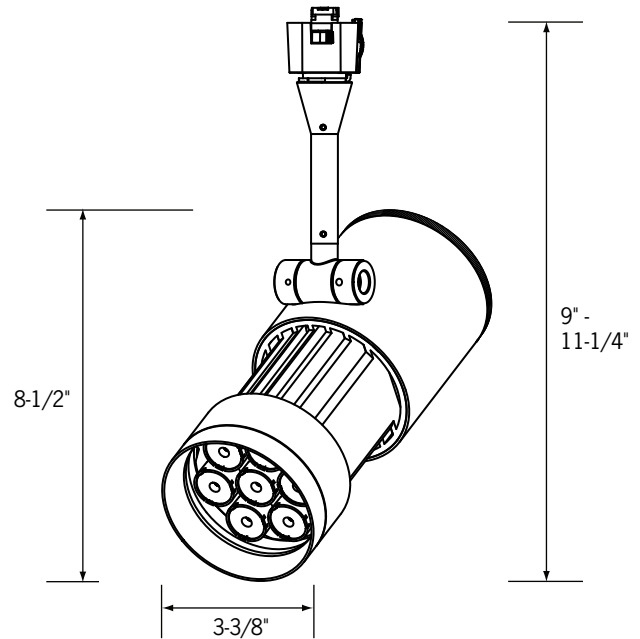

Ordering Information

Example Order: -

Track System	Fixture	Wattage	Beam	Color Temp	Dimming	Finish	Accessories
CTL - ConTech HTL - Halo LTL - Lightolier PTL - Capri	800	1 - 18W/ 1300Lm 2 - 27W/ 1700Lm	S - Spot M - Medium F - Flood	27 - 2700K 3 - 3000K 35 - 3500K	D - Dimming	B - Black P - White S - Silver	LA-35 - Black Honeycomb Louver LA-44-(B,P,S) - Egg Crate Louver LF18 - A, B, CL, G, LB, R, RO, Y, 73, LS, SL, UV 3-1/16" Dia. Tempered Glass Lenses

1. Juno is a registered trademark of Juno Lighting
2. Halo is a registered trademark of Cooper Lighting
3. Lightolier is a registered trademark of Philips Lighting
4. Capri is a registered trademark of Philips Lighting

Color/Pattern Legend
-A (Amber), -B (Blue), -CL (Clear),
-G (Green), -LB (Light Blue), -R (Red),
-RO (Rose), -Y (Yellow), -73 (Spread Lens),
-LS (Linear Spread Lens), -SL (Soft Light),
-UV (Optivex UV Filter)

CTL800

18W and 27W LED Cylinder Track Fixture

Photometrics

CTL8001M3

Designed for 50,000 Hour Lamp Life*; LM-63Test No. 80828

Light Output (Fixture Lumens): 1319
 Total Watts@120V: 17
 Lumens Per Watt: 78
 Color Rendering Index (CRI)¹: 82
 Color Temperature (CCT)²: 3022K Warm White
 Spectral Power Distribution Chart³
 LM-79 Test No. 80840

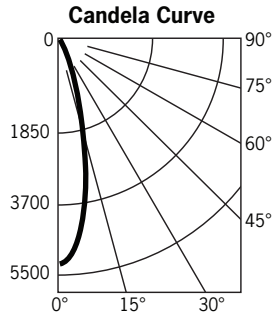
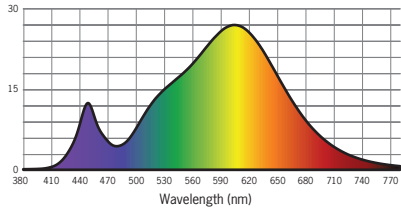

Candlepower Summary

FROM 0	CANDELA	LUMENS
0	5452	
5	4862	420
15	2099	574
25	454	227
35	82	58
45	29	23
55	13	12
65	3	3
75	1	1
85	1	1
95	0	

Intensity Distribution

DISTANCE (FT.)	FOOTCANDLES (FC)	BEAM DIAMETER (FT.)
6'	151.4	2.5
8'	85.2	3.4
10'	54.5	4.2
12'	37.9	5.1
14'	27.8	5.9
16'	21.3	6.8

Beam Distribution: 25°
 Spacing Criterion: 0.42

CTL8002S3

Designed for 50,000 Hour Lamp Life*; LM-63Test No. 80824

Light Output (Fixture Lumens): 1710
 Total Watts@120V: 26
 Lumens Per Watt: 66
 Color Rendering Index (CRI)¹: 81
 Color Temperature (CCT)²: 2992K Warm White
 Spectral Power Distribution Chart³
 LM-79 Test No. 80836

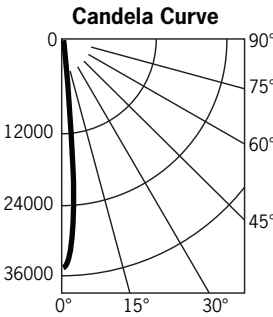
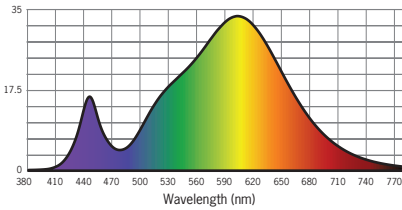

Candlepower Summary

FROM 0	CANDELA	LUMENS
0	34569	1330
5	20594	294
15	924	40
25	78	23
35	34	13
45	16	8
55	9	2
65	2	1
75	1	0
85	0	0
95	0	

Intensity Distribution

DISTANCE (FT.)	FOOTCANDLES (FC)	BEAM DIAMETER (FT.)
6'	960.3	1.2
8'	540.1	1.6
10'	345.7	2.0
12'	240.1	2.4
14'	176.4	2.7
16'	135.0	3.1

Beam Distribution: 11°
 Spacing Criterion: 0.19

CTL8002M3

Designed for 50,000 Hour Lamp Life*; LM-63Test No. 80825

Light Output (Fixture Lumens): 1731
 Total Watts@120V: 27
 Lumens Per Watt: 65
 Color Rendering Index (CRI)¹: 80
 Color Temperature (CCT)²: 3029K Warm White
 Spectral Power Distribution Chart³
 LM-79 Test No. 80837

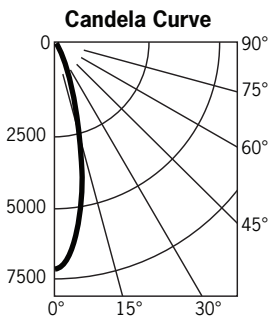
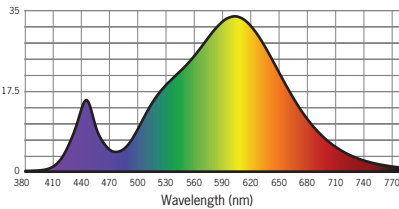

Candlepower Summary

FROM 0	CANDELA	LUMENS
0	6982	542
5	6256	760
15	2780	302
25	605	74
35	105	29
45	36	15
55	16	5
65	4	2
75	2	2
85	2	2
95	0	

Intensity Distribution

DISTANCE (FT.)	FOOTCANDLES (FC)	BEAM DIAMETER (FT.)
6'	193.9	2.6
8'	109.1	3.5
10'	69.8	4.3
12'	48.5	5.2
14'	35.6	6.1
16'	27.3	7.0

Beam Distribution: 26°
 Spacing Criterion: 0.43

1. Accuracy of rendering colors
 2. Color appearance of light source
 3. Colors present within the light source

*Dependent on surrounding temperatures

CTL800

18W and 27W LED Cylinder Track Fixture

Photometrics

CTL8002F3

Designed for 50,000 Hour Lamp Life*; LM-63 Test No. 80826

Light Output (Fixture Lumens): 1494
 Total Watts@120V: 26
 Lumens Per Watt: 58
 Color Rendering Index (CRI)¹: 82
 Color Temperature (CCT)²: 3066K Warm White
 Spectral Power Distribution Chart³
 LM-79 Test No. 80838

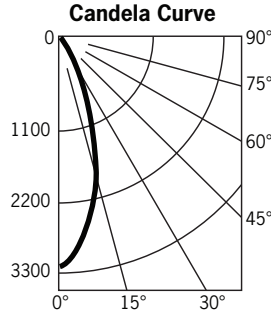
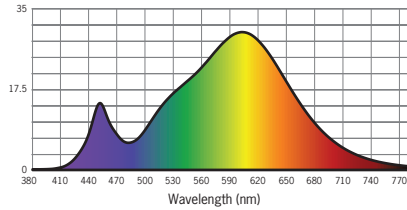

Candlepower Summary

FROM 0	CANDELA	LUMENS
0	3205	
5	3027	275
15	2008	550
25	851	397
35	258	171
45	79	64
55	28	25
65	7	8
75	3	3
85	2	2
95	0	

Intensity Distribution

DISTANCE (FT.)	FOOTCANDLES (FC)	BEAM DIAMETER (FT.)
6'	89.0	3.6
8'	50.1	4.8
10'	32.1	5.9
12'	22.3	7.1
14'	16.4	8.3
16'	12.5	9.5

Beam Distribution: 37°
 Spacing Criterion: 0.59

1. Accuracy of rendering colors
 2. Color appearance of light source
 3. Colors present within the light source

*Dependent on surrounding temperatures