

202 SurroundLite™ | Pendant

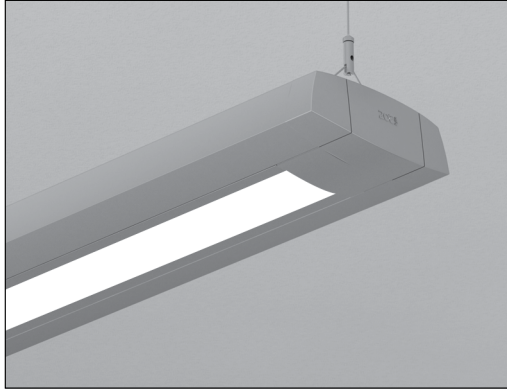

Spotless Lens

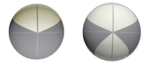
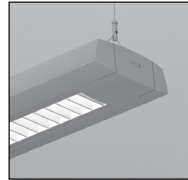

Louver

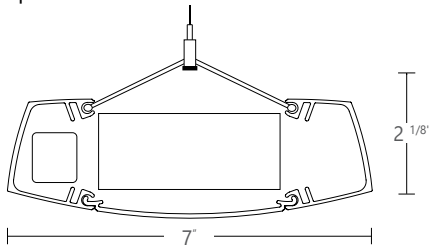

Project _____

Type _____

Notes _____

PERFORMANCE PER LINEAR FOOT AT 3500K (SO)

DISTRIBUTION	NOMINAL LUMEN OUTPUT		INPUT WATTS	EFFICACY
	UP	DOWN		
80up/20down at 1000 lm/ft	800 lm/ft	200 lm/ft	12.78 w/ft	78 lm/w
80up/20down at 800 lm/ft	640 lm/ft	160 lm/ft	10.06 w/ft	80 lm/w

* Based on a 4 foot luminaire using one driver
Please consult factory for custom lumen output and wattage



Axitune
Dim-to-Warm



Axitune
Tunable White



PoE



SurroundLite™



Control
Sensors



Ordering Guide

202LED		LIGHT ENGINE		NOMINAL LUMENS/FT		CRI		COLOR TEMP. (choose one)			
PRODUCT ID											
202LED	Pendant LED	SL 80/20	SurroundLite 80% up/20% down (semi-indirect)	800	800 lm/ft - Min	80	80 CRI	30	3000 K	TW2750	2700-5000 K - Tunable White
		SL 100/0	SurroundLite 100% up/0% down (indirect)	1000	1000 lm/ft - Max	90	90 CRI	35	3500 K	TW2765	2700-6500 K - Tunable White
								40	4000 K	DW3020	3000-2000 K - Dim to Warm
				Applies to both UP & DOWN. Outputs between listed min and max are available. Consult factory for outputs outside of the listed range. Consult factory for max output with 90 CRI		Applies to both UP & DOWN.		Applies to both UP & DOWN.			

SHIELDING		FIXTURE LENGTH		FINISH		VOLTAGE		DRIVER		
SO	spotless lens*	Semi-Indirect option only (SL 80/20)	4 4'	AP	aluminum paint	120	120 V	DP	dimming (0-10V) 1%	
PL	louver		8 8'	W	white	277	277 V	LT(#)	Lutron*	
NO	no shielding	Indirect option only (SL 100/0)	12 12'	BLK	black	347	347 V	BI	bi-level dimming	
			S(L) System Run	C	custom	UNV	universal	O(#)	other**	
						DC	low voltage*	TW(#)	tunable white drivers*	
								POE(#)	POE drivers*	
* Default lens for Color Tuning and Tunable white. Consult factory for other lens.						Applies to both UP & DOWN. * Only available with POE drivers.		Applies to both UP & DOWN. * See page 4 to specify system ** Please consult factory, see page 4.		

CIRCUITS		MOUNTING/SUSPENSION		BATTERY (OPTIONAL)		OTHER		IC CONTROLS (OPTIONAL)		CUSTOM	
1	1 circuit *	CA(L)	drywall+cable length (36" std.)	B(#)	battery pack (integral)	F	fuse	DS(#)	daylight sensor	C	custom
2	2 circuits	CT9(L)	TB/TG 9/16+cable length (36" std.)					OS(#)	occupancy sensor		
2A/B	2 circuit alternating/4ft	CT15(L)	TB/TG 15/16+cable length (36" std.)					DOS(#)	daylight & occupancy sensor		
+E(#)	emergency section	CTS(L)	ST+cable length (36" std.)					EN(#)	Enlighted integral		
+NL(#)	night light section	SA(L)	drywall+stem length >48" (18" std.)					ENR(#)	Enlighted remote		
+GTD(#)	generator transfer device	+SM	seismic option					WC(#)	wireless control dimming		
* Control UP & DOWN lights together		See Ceiling Mount Guide for further details		For minimum 36" long fixture only Not available with 347V Please consult factory		Requires 120V or 277V		Applies to both UP & DOWN. Specify quantity. Requires 8" blank See integrated controls guide for more details. Consult factory for Tunable White.		Please specify	

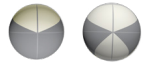

● SURROUNDLITE TECHNOLOGY

202 with SurroundLite provides the flexibility of high efficacy spherical three dimensional wide batwing distributions and shielding options that all result in true lighting effectiveness. 202 has an integral driver and a light guide with proper cutoff and no view of bugs or dust particles.

An innovative technology to get much more out of LEDs: Axis SurroundLite is based on the fundamental physics of how light interacts with matter. The specially engineered lightguide is made of precisely coded and aligned molecules that shape LED output in all three dimensions.

With SurroundLite extra-wide, multidimensional light distribution, light is directed in all three planes and sent in every corner of the room. SurroundLite brings the promise of balanced brightness, facilitating lighting design.

3D Polar Curve (SL 80/20)

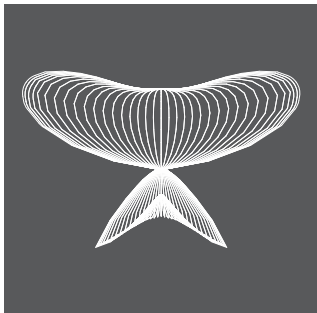

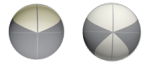

● LIGHT GUIDE

High precision light guide made of PMMA material, allows distribution of controlled light in all 3-dimensions to put light on both vertical and horizontal planes within the space. Patented lightguide design featuring molecular optics and precision-coupled optic components yield a high efficiency luminaire. In-plane mixing maximizes color uniformity while light emitting area is uniform and diffuse without 'head lighting' from the LED's.

● LENGTHS

202 SurroundLite 4ft (4)

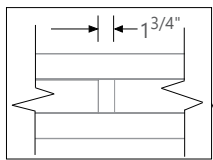
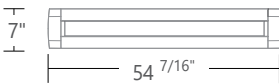

For all fixture lengths

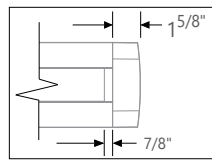

For all fixture lengths

202 SurroundLite 8ft

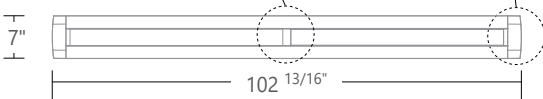

202 SurroundLite 12ft

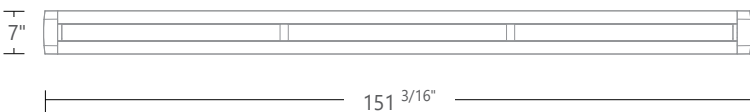

● SYSTEMS (S#)

Runs of 202 SurroundLite that are greater than 12ft in length are designated as systems (S#). This means that the run is comprised of a combination 4ft and/or 8ft and 12ft sections to be assembled on site using our joining system. For more information on systems and joining, please refer to the 202 SurroundLite installation sheets available at: www.axislighting.com under 'Downloads' tab.

● WEIGHT

202 SurroundLite 4ft	12 lbs / 5.4 kg
202 SurroundLite 8ft	24 lbs / 10.9 kg
202 SurroundLite 12ft	36 lbs / 16.3 kg

● OPTICS

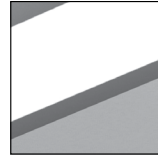

SO spotless lens

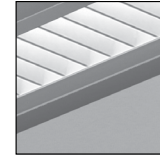

PL flat blade louvers

● SUSPENSION / MOUNTING SPACING

Standard Suspension Length:

CABLE : 36" (Adjustable length)

STEM: 18" (For 8' length maximum)

Between Mounting Points:

202 SL 4' (48")

202 SL 8' (96")

202 SL 12' (144")

NOTE: Mounting points are moveable

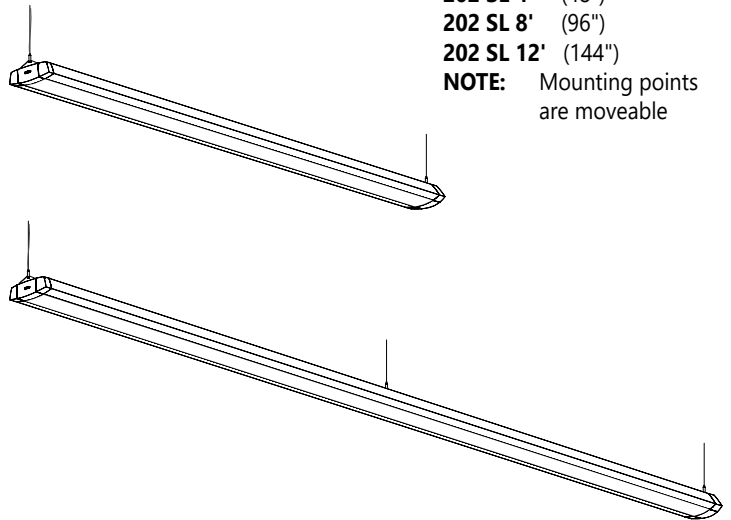

i Row configuration and mounting spacing file is available for download at: www.axislighting.com

● FINISH

Aluminum paint, powder coated and custom finishes are also available.

● APPROVALS

Certified to UL and CSA standards Suitable for damp locations.

● OTHER MOUNTING OPTIONS

202 SurroundLite is also available as a wall mount.

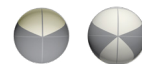

● MOUNTING OPTIONS

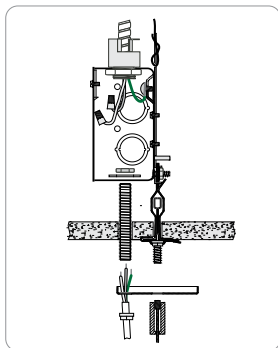

CT TILE CEILING - ON GRID

Mounting options are also available for slope ceiling and seismic bracing.

i Installation sheets for all mounting options are available at: www.axislighting.com under 'Downloads' tab.

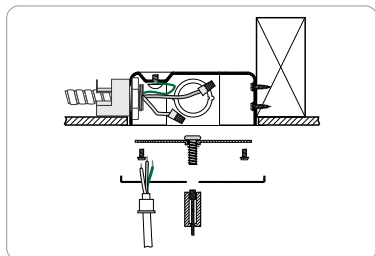

CA DRYWALL CEILING

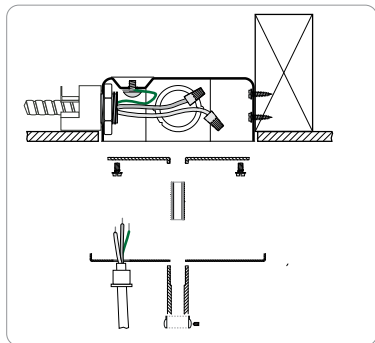

SA STEM MOUNT IN DRYWALL CEILING

i Specification sheets for pendant mounted 202 SurroundLite luminaires are available at: www.axislighting.com under 'Downloads' tab.

● CONSTRUCTION

Housing	Extruded aluminum (0.075" nominal)
End Cap	Die cast aluminum (0.10" nominal)
Joiners	Die cast aluminum (0.10" nominal)
Top Covers	Cold rolled sheet steel painted (24 gauge)
Smooth Lens	Uniform frosted acrylic lens
Flat blade louvers	Semispecular aluminum material (electronically anodized) for added visual comfort

● ELECTRICAL

Lutron driver*	LDE1 - Hi-lume 1% EcoSystem with Soft-on, Fade-to-Black LTEA - Hi-lume 1% 2-wire (120V forward phase only) *Consult factory
Other drivers**	DALI - Digital Addressable Lighting Interface DMX - Digital Multiplex LV - line voltage - Advance Mark 10 Xitanium SR - For wireless sensor
Tunable White TW drivers*	DALIDT6 - DALI Type 6 (Two DALI Addresses) DALIDT8 - DALI Type 8 (One DALI Address) LTTW - Lutron T-Series Tunable White
Power over Ethernet POE drivers*	MOLEX IGOR O - Other (Consult factory) UL2108 certified for integral or remote driver
Emergency	Integral emergency battery pack or emergency circuit optional.
Input Voltage	120V, 277V, 347V, UNV, DC.

*Choose driver from available options.

i Incorporating these components may have limitations or affect the length of the luminaire. Please contact factory for more details.

● LED SYSTEM

CRI	Minimum 80 or 90 color rendering index.
CCT Single Color	Choice of 2700K, 3000K, 3500K and 4000K color temperature with a great color consistency (within 3-step MacAdam ellipse). Both within fixture and fixture to fixture.
CCT Axitune Systems	Consult Axitune technical sheet for more information on color technology.
LED life	Minimum 50,000h with 85% of lumen maintenance in 25°C ambient temperature, in compliance with IES LM-80 testing measurements.
Thermal Management	Aluminum housing acting as the heat sink to maximize life.
Environment	Dry and damp rated in operating ambient temperatures of 0-40°C (32-104F).

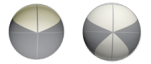

● PHOTOMETRIC DATA

SATIN RIBBED LENS (SR)

202LED-SL80_20-800-80-35-SR
80% up / 20% down at 800 lm/ft

PHOTOMETRIC CURVE

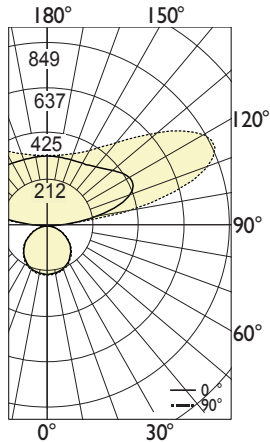

Luminaire Lumens: 3228 lm
Input Watts: 40.23 W
Efficacy: 80 lm/W
IES FILE: 202LED-SL70_30-800-80-35-SR.ies
TESTED ACCORDING TO IES LM-79-2008

CANDELA DISTRIBUTION

Vertical Angle	Horizontal Angles				
	0	22.5	45	67.5	90
0	224	224	224	224	224
5	221	223	222	225	225
15	214	217	217	219	219
25	201	203	205	207	207
35	180	182	184	185	184
45	152	155	155	156	156
55	118	120	120	121	121
65	79	80	80	81	81
75	38	39	40	41	41
85	3	4	6	9	9
90	0	1	1	3	2
95	82	85	82	77	80
105	319	344	420	538	602
115	435	476	597	764	848
125	420	456	560	696	758
135	370	395	460	539	573
145	338	351	386	427	443
155	324	330	347	365	371
165	320	321	328	336	338
175	319	321	321	323	323
180	321	321	321	321	321

ZONAL LUMENS

Zone	Lumens
0	
0-10	21
10-20	61
20-30	94
30-40	115
40-50	119
50-60	107
60-70	79
70-80	42
80-90	9
90-100	111
100-110	455
110-120	604
120-130	515
130-140	363
140-150	246
150-160	162
160-170	93
170-180	31
180	

LUMINANCE DATA (cd/m²)

Vertical Angle	Horizontal Angles		
	0	45	90
45	1986	2025	2038
55	1901	1933	1949
65	1727	1749	1771
75	1356	1428	1464
85	318	636	954

LOUVER (PL)

202LED-SL80_20-800-80-35-PL
80% up / 20% down at 800 lm/ft

PHOTOMETRIC CURVE

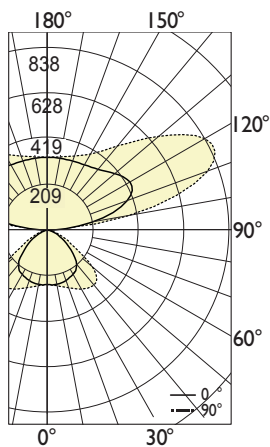

Luminaire Lumens: 3300 lm
Input Watts: 40.8 W
Efficacy: 81 lm/W
IES FILE: 202LED-SL70_30-800-80-35-PL.ies
TESTED ACCORDING TO IES LM-79-2008

CANDELA DISTRIBUTION

Vertical Angle	Horizontal Angles				
	0	22.5	45	67.5	90
0	245	245	245	245	245
5	247	247	247	247	247
15	263	262	255	248	245
25	290	280	257	241	235
35	318	290	246	225	222
45	314	263	205	179	175
55	186	155	113	100	105
65	87	59	44	48	51
75	29	19	16	17	19
85	5	4	3	3	3
90	1	1	1	0	0
95	68	75	83	82	83
105	603	534	415	338	306
115	836	751	588	467	422
125	748	684	557	450	417
135	567	532	457	394	373
145	435	418	384	356	345
155	370	364	351	338	333
165	342	340	335	330	328
175	329	329	328	327	327
180	327	327	327	327	327

ZONAL LUMENS

Zone	Lumens
0	
0-10	24
10-20	72
20-30	120
30-40	161
40-50	169
50-60	116
60-70	55
70-80	21
80-90	4
90-100	110
100-110	450
110-120	593
120-130	508
130-140	361
140-150	245
150-160	163
160-170	95
170-180	31
180	

LUMINANCE DATA (cd/m²)

Vertical Angle	Horizontal Angles		
	0	45	90
45	4954	3237	2756
55	3618	2204	2036
65	2283	1164	1349
75	1233	668	802
85	627	358	333