

Project _____

Type _____

Notes _____



A configuration drawing is required

Factory is available for assistance
See page 3 for example of how to specify

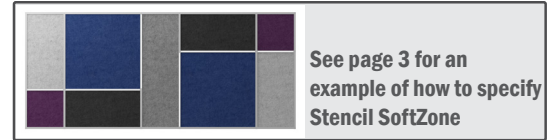

Ordering Guide

* See page 8 for more information.

STSZ		TOTAL LENGTH & NOM. LUMENS/FT - INDIRECT				TOTAL LENGTH & NOM. LUMENS/FT - DIRECT				TOTAL LENGTH - BLANK (OPT.)					
PRODUCT ID		+SLI(length, lumen)		+SLIA(length, lumen)		+DSO(length, lumen)		+DMLBK(length, lumen)		+DMLG(length, lumen)		BK(L) blank			
STSZ Stencil SoftZone		SurroundLite indirect	175	175	Im/ft	direct spotless lens	200	200	Im/ft	direct micro louver black*	300	300	Im/ft	SO lens option only	
		SurroundLite indirect asym.	250	250	Im/ft	direct micro louver grey*	400	400	Im/ft	ND no direct	150	150	Im/ft		micro louver option only
		NI no indirect	350	350	Im/ft										
			500	500	Im/ft										
			700	700	Im/ft										
			1000	1000	Im/ft										
		Lit segments are available in 1' increments. Segment length from 2' to 8' continuous.				Lit segments are available in 1' increments. Segment length from 2' to 8' continuous. * Micro louver recommended at outputs over 500 lm/ft. Louver comes in grey finish only.				Available in any length; min 7', max 8'.					

HUB QUANTITY		CRI	COLOR TEMP.	FINISH	VOLTAGE	DRIVER					
SERIES A	SERIES B										
+AL(#) L Hub (90°)	+BT(#) Triangle Hub (60°)	80	80 CRI	27	2700 K	AP aluminum paint	120	120 V	MD	integral mini driver	
+AT(#) T Hub (90°)	+BX(#) X Hub (120°)	90	90 CRI	30	3000 K	W white	277	277 V		0-10V dimming (1%)*	
+AX(#) X Hub (90°)	+BYN(#) Negative Y Hub (60°/120°)			35	3500 K	BLK black	347	347 V *	POE(#)	POE drivers**	
+AY(#) Y Hub (120°)	+BYP(#) Positive Y Hub (120°/60°)			40	4000 K	C(#) custom*	UNV	universal			
+AH(#) Hex Hub (120°)							DC	low voltage**			
+AI(#) Inline Hub (180°)											
Consult factory for compatibility when mixing series A & B.		Applies to both Up and Down		Applies to both Up and Down		* To match your housing finish with selected standard panel colors see suggested codes on page 4.		* Consult factory ** Only available with POE drivers.		* Only integral 0-10V mini driver available ** Specify system	

CIRCUITS	MOUNTING/SUSPENSION	CANOPY	BATTERY - REMOTE (OPT.)	CUSTOM (OPT.)
1 1 circuit	CA(L) drywall+cable length (36" std.)	RC round canopy	B(#) remote battery pack	C custom
2 2 circuits	CT9(L) TB/TG 9/16+cable length (36" std.)	SC square canopy		
3 3 circuits	CT15(L) TB/TG15/16+cable length (36" std.)			
+E(#) emergency circuit *	CTS(L) ST+cable length (36" std.)			
+NL(#) night light circuit				
* Specify quantity	Specify length	White canopy standard	Remote only Not available with 347V Please consult factory	Please specify

Please continue code line with elements on page 2

See page 2 for MikroLite, Accent and SoftZone Panels Ordering Guide

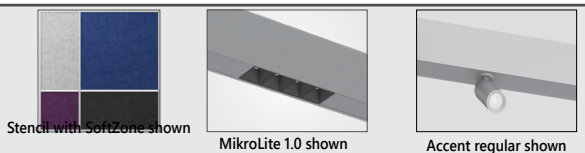

Ordering Guide - SoftZone Panels

		Panel ID (Color, QTY)						
		PANEL ID		SOFTZONE PANEL COLOR			PANEL QUANTITY	
				STANDARD PALETTE	EXTENDED CUSTOM PALETTE *			
Square	+SQ22	2'x2' square	COT	cotton	CUSFRO	frost		# panel quantity
	+SQ33	3'x3' square	TIN	tin	CUSDEN	denim		
	+SQ44	4'x4' square	CON	concrete	CUSNAV	navy		
Rectangular	+RE23	2'x3' rectangular	SLA	slate	CUSPEB	pebble		
	+RE24	2'x4' rectangular	CAR	carbon	CUSSMO	smoke		
	+RE25	2'x5' rectangular	SAN	sand	CUSAPP	apple green		
	+RE26	2'x6' rectangular	COR	cork	CUSOLI	olive		
	+RE27	2'x7' rectangular	COP	copper	CUSEME	emerald		
	+RE28	2'x8' rectangular	BAR	bark	CUSANC	anchor		
	+RE34	3'x4' rectangular	EAR	earth	CUSSHA	shadow		
	+RE35	3'x5' rectangular	PUR	purple	CUSWHE	wheat		
	+RE36	3'x6' rectangular	OCE	ocean	CUSSAC	sand castle		
	+RE37	3'x7' rectangular	LEM	lemon	CUSLEA	leather		
	+RE38	3'x8' rectangular	LIM	lime	CUSPER	peru		
	+RE45	4'x5' rectangular	BRI	brick	CUSMOS	moss		
	+RE46	4'x6' rectangular			CUSMAR	marble		
	+RE47	4'x7' rectangular			CUSMOC	moccasin		
	+RE48	4'x8' rectangular			CUSGIN	ginger ale		
Triangle- 60° only	+TR2	2' triangle- 60° only			CUSASP	asphalt		
	+TR3	3' triangle- 60° only			CUSFOS	fossil		
	+TR4	4' triangle- 60° only			CUSCRI	crimson		
Hexagon (full)	+HE2	2' hexagon (full)			CUSMAN	maroon		
Hexagon (triangle segment)	+HET2	2' hexagon (triangle segment)			CUSFIR	fire brick		
	+HET3	3' hexagon (triangle segment)			CUSIND	indigo		
	+HET4	4' hexagon (triangle segment)			CUSBUR	burnt orange		

See page 4 for more details.
* Extended custom color palette panels available per request. Consult factory for details.

Bottom views

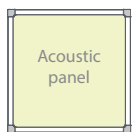

SQ - Square

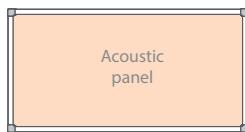

RE - Rectangular

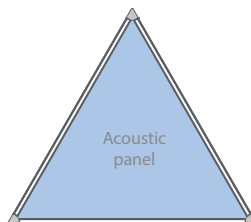

TR - Triangle (60° only)

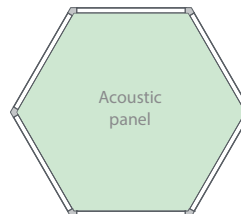

HE - Hexagon (full)

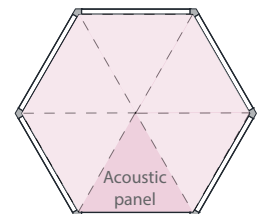

HET - Hexagon (triangle segment)

Ordering Guide-MikroLite and Accent (Optional)

* For Accent only, specify the total blank length. Specify NI and ND for total direct & indirect length.

MKL (#, Beam Angle, Finish)			AC (#, Option, Beam, Finish)			
MIKROLITE MODULE QTY	BEAM ANGLES	CELL FINISH	ACCENT QTY	OPTION	BEAM	FINISH
# MikroLite module quantity	MKL35 35 deg MKL20 20 deg	GR gray BLK black	# accent quantity	R regular	AC20 20 deg AC35 35 deg	AP aluminum paint W white BLK black
1 module contains 4 MikroLites; Module length is 4". Minimum length for MikroLite option is 3". Minimum distance from edge 3". 500 lm/module. See page 9 for more information.			Only available in 500 lumens, with 0-10V dimming (1%). Minimum spacing between Accents is 4". Accent provided on blank section by default (min length 2 ft). Also compatible with indirect segments (min length 4 ft). See page 9 for more information.		See page 6 for more information. Not available on Hub.	

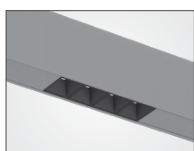

MikroLite 1.0 shown

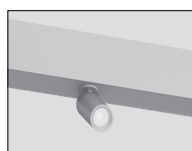

Accent regular shown

How to specify Stencil SoftZone

Example

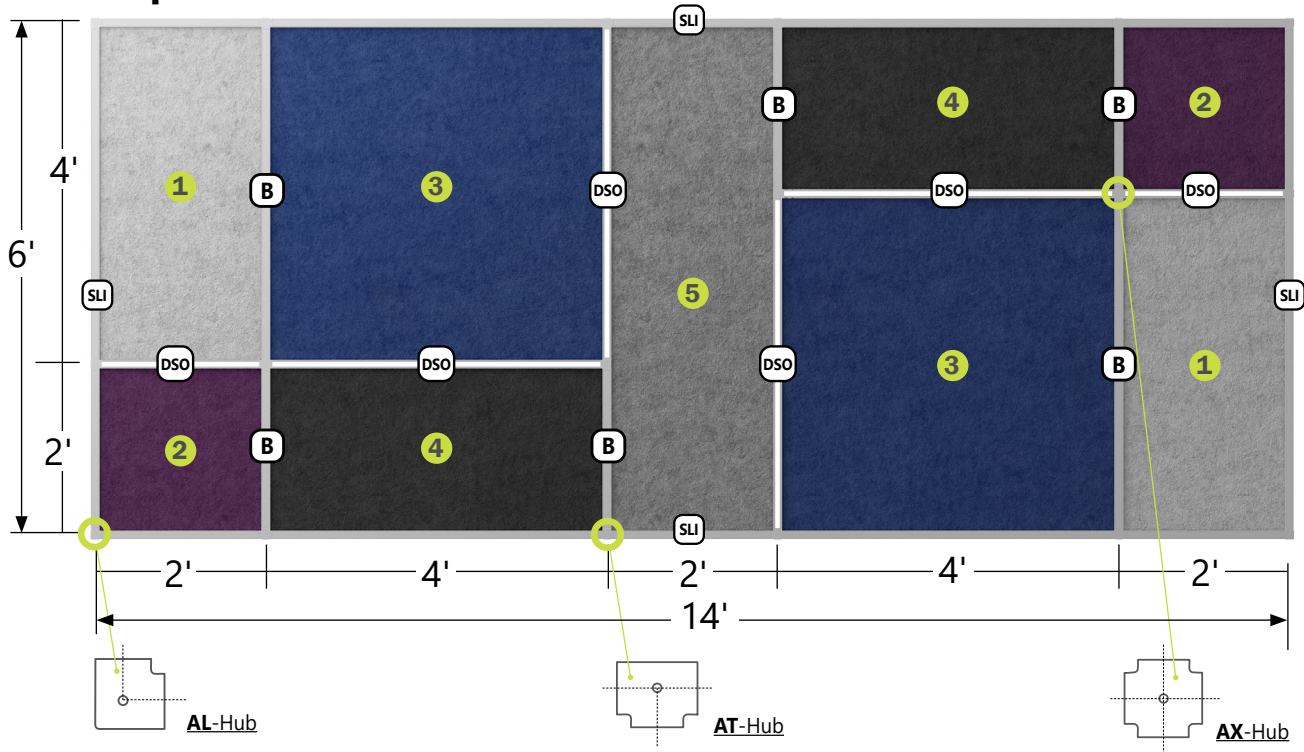

1. Specify Total Length & Lumens - Indirect

+SLI(40, 1000)
TOTAL LENGTH* & NOM. LUMENS/FT -
INDIRECT SURROUNDLITE

SLI 14'x2+6'x2

2. Specify Total Length & Lumens - Direct

+DSO(20, 400)
TOTAL LENGTH* & NOM. LUMENS/FT - DIRECT

DSO 2'x2+4'x4

3. Specify Total Length - Blank

B(16)
TOTAL LENGTH** - BLANK

B 2'x4+4'x2

4. Specify Hub Quantity

AL(4)+AT(11)+AX(2)
HUB QTY

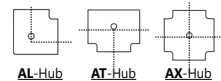

5. Specify SoftZone Panels***

**RE24 (COT, 2)+SQ22 (PUR, 2)+
SQ44 (OCE, 2)+RE24 (CAR, 2)+
RE26 (CON, 1)**
SoftZone Panel Type - Panel ID (Color, QTY)

1 + 2 + 3 + 4 + 5

*Segment length from 2' to 8' continuous in one foot increments. Specify total linear length of each distribution.

**Blank segments: available in any length; min 7", max 8'.

*** To specify all panel types, list them with "+" inside ordering code, according to the example above.

SOFTZONE PANEL COLOR PALETTE

WITH MATCHING HOUSING COLORS

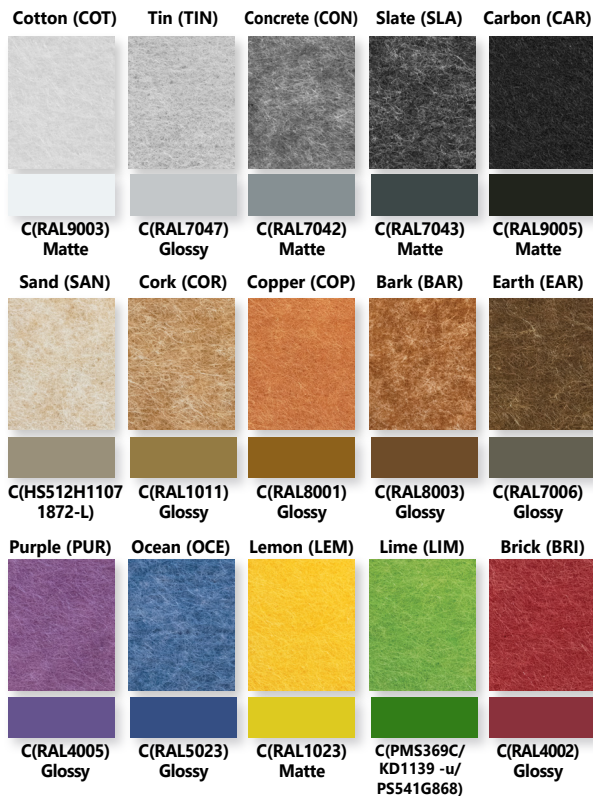

EXTENDED SOFTZONE PANEL COLOR PALETTE

Available per request. Consult factory for details.



SOFTZONE PANEL SHAPE & LUMINAIRE SEGMENT LENGTH

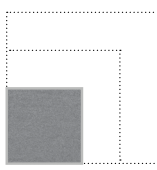

Square
2' x 2', 3' x 3', 4' x 4'

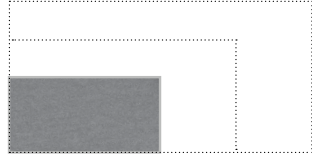

Rectangle
2' x 8' 3' x 8' 4' x 8'
2' x 7' 3' x 7' 4' x 7'
2' x 6' 3' x 6' 4' x 6'
2' x 5' 3' x 5' 4' x 5'
2' x 4' 3' x 4' 5'
2' x 3'

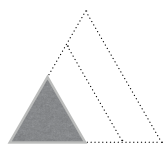

Triangle 60°
2', 3' and 4' section lengths



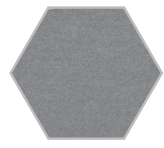

Hexagon (full)
2' full hexagon

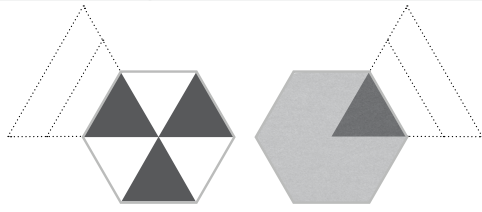

Hexagon (triangle segment)
2', 3' and 4' section lengths

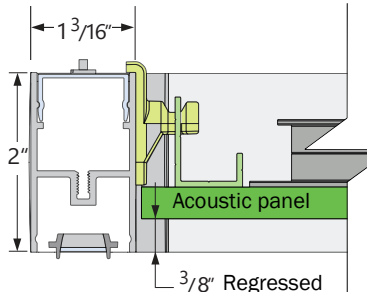

1 3/16"
2"
Acoustic panel
3/8" Regressed

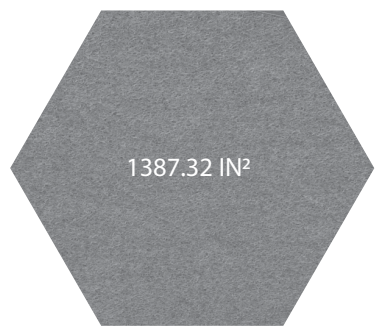
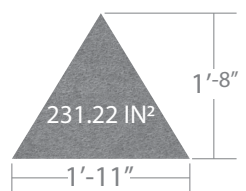
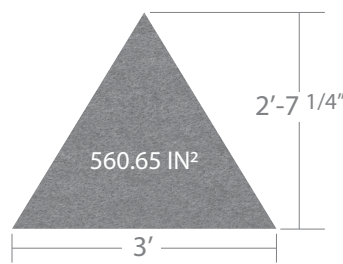
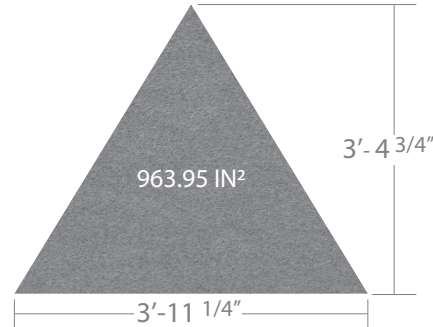
	2FT	3FT	4FT
Hexagon (full)	 1387.32 IN ²	NOT AVAILABLE	NOT AVAILABLE
Hexagon (triangle segment)	 231.22 IN ² 1'-8" 1'-11" (23.108" x 20.012")	 560.65 IN ² 2'-7 1/4" 3' (35.983" x 31.162")	 963.95 IN ² 3'-4 3/4" 3'-11 1/4" (47.182" x 40.861")

OPEN SHAPES EXAMPLES



2', 3' and 4' Stencil SoftZone triangular panels

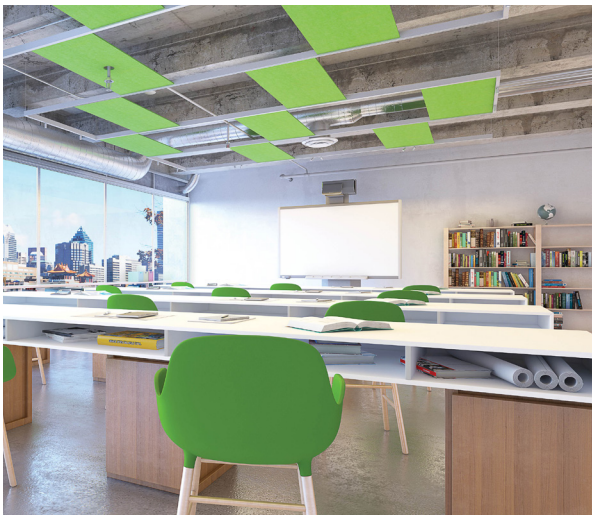
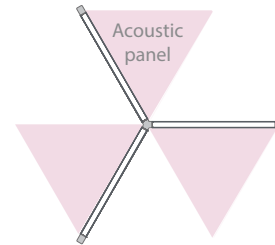

2'x4' Stencil SoftZone rectangular panels

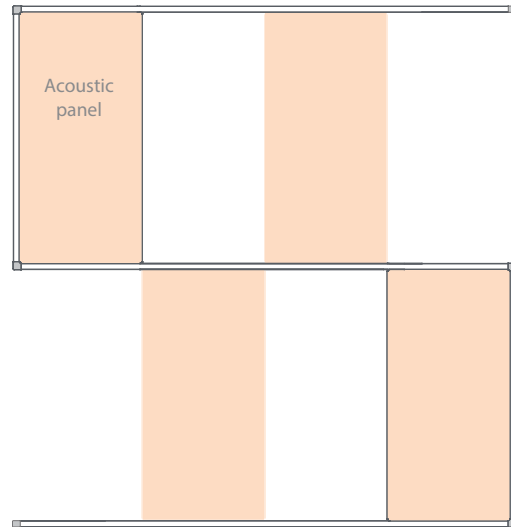

2' Stencil SoftZone hexagonal panels

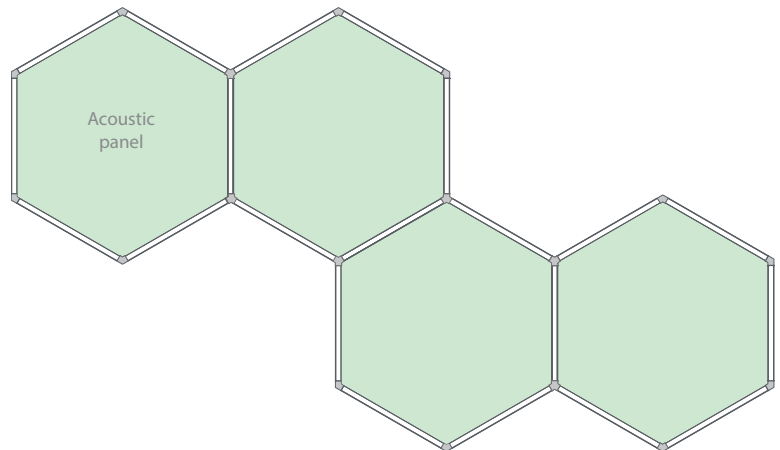

● SEGMENT LENGTHS AND MOUNTING POINTS

Segment length X1			Mounting points X2	
Feet	Inches	mm	Inches	mm
2	22.250	565	24.000	610
3	35.125	892	36.875	937
4	46.250	1175	48.000	1219
5	57.375	1457	59.125	1502
6	70.250	1784	72.000	1829
7	81.375	2067	83.125	2111
8	94.250	2394	96.000	2438

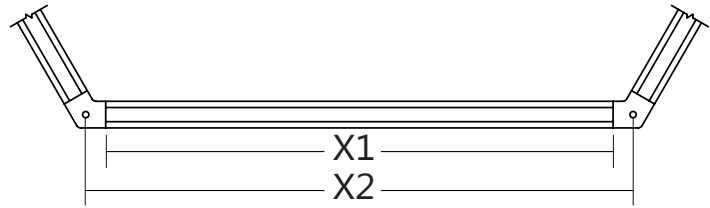

X1 - Segment length
X2 - Mounting points



i Segment length from 2' to 8' continuous.
Lengths above 8' will require Inline Hub.
Available in 1' increments.

● SECTION VIEWS

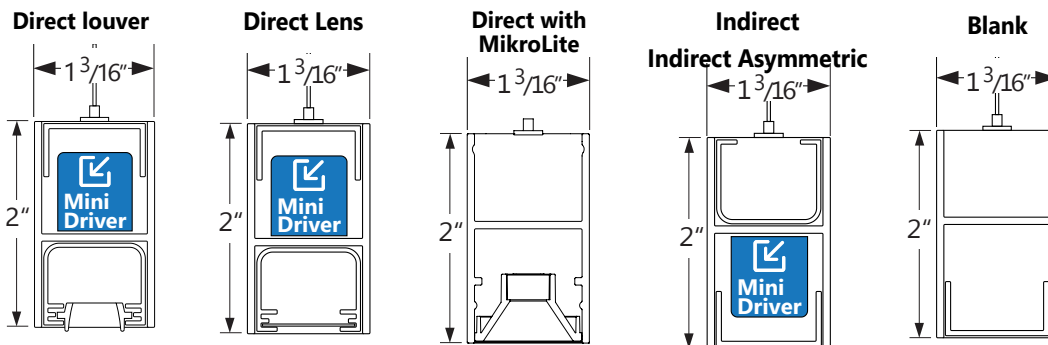

● HUB SERIES A

Patent-pending system combining mechanical, electrical and suspension functions. Non-illuminated lighting segment connectors:

L-Hub (90°), T-Hub (90°), X-Hub (90°), Y-Hub (120°), Hex-Hub (120°), Inline-Hub (180°).

L-Hub	T-Hub	X-Hub	Y-Hub-120	Hex-Hub	Inline -Hub
<p>90°</p>	<p>90°</p>	<p>90°</p>	<p>120°</p>	<p>120°</p>	<p>180°</p>

● HUB SERIES B

Patent-pending system combining mechanical, electrical and suspension functions. Non-illuminated lighting segment connectors:

Positive-Y-Hub (120°/ 60°), Negative-Y-Hub (60°/120°), X-Hub (60°/120°), and Triangle-Hub (60°).

Positive-Y-Hub	Negative-Y-Hub	X-Hub-120	Triangle-Hub
<p>60°</p> <p>120°</p>	<p>60°</p> <p>120°</p>	<p>60°</p> <p>120°</p>	<p>60°</p>

● CLEANING PROTOCOL



NOTE: Easy to clean. Made from polyester fill with natural anti-microbial properties.



Periodic dusting with vacuum or dry cloth recommended.



For stain removal, use a small amount of soap or detergent on a wet cloth.



For added disinfection, use bleach solution (5 tablespoons per Gallon of water), spray onto surface and gently wipe to spread all over.

● APPROVALS



Certified to UL and CSA standards. UL US
Suitable for damp locations.

FIRE SAFETY: Class A Fire Rated as per ASTM E84.

Flame Spread Index: 5

Smoke Development Index: 110

● LED SYSTEM

CRI	Minimum 80 or 90 color rendering index
CCT	Choice of 2700K, 3000K, 3500K and 4000K color temperature with a great color consistency (within 3.0-step MacAdam ellipse).
LED life	Minimum 50,000h with 85% of lumen maintenance in 25°C ambient temperature, in compliance with IES LM-80 testing measurements.
Thermal Management	Aluminum housing acting as the heat sink to maximize life.
Performance	Up to 101 lm/W.

● CONSTRUCTION

Housing	Extruded aluminum (0.070" nominal)
End Cap+Joiner	Die cast aluminum
Reflectors	Extruded acrylic
Suspension	1 mm Aircraft cable
Cable Grips	Quick Connecting / Release

● ELECTRICAL

Mini driver STENCIL features integral mini driver technology. 0-10V 1% dimming standard. The integral mini driver is the only driver available.

Power over Ethernet POE drivers* MOLEX
IGOR
(consult factory for more information) O - Other (Consult factory)

UL2108 certified for integral or remote driver

Emergency Remote emergency battery pack or emergency circuit optional.

Input Voltage 120V, 277V, UNV, 347V

i Incorporating these components may have limitations or affect the length of the luminaire, please contact factory for more details.

● WARRANTY

Axis Lighting will warrant defective LEDs, boards, and drivers for 5 years from date of purchase. Warranty is valid if luminaire is installed and used according to specifications. If defective, Axis will send replacement boards or drivers at no cost along with detailed replacement instructions and instructions on how to return defective components to Axis.

● STENCIL PENDANT WITH MIKROLITE 1.0



1 module contains 4 Mikrolites

● STENCIL SEGMENTS

Stencil lit segments are available in lengths of 2' to 8' in one foot increments. Unlit blank segments are available in any length from 7" to 8'. Segments exceeding 8' in length are comprised of a combination of lengths to be assembled on site with an Inline Hub. Minimum blank segment length for one Accent is 3'. Minimum segment length for Accent and Indirect is 6'. For more information on systems and joining, please refer to the Stencil installation sheets available for download at www.axislighting.com.

● LIGHT GUIDE

High precision light guide made of PMMA material, allows distribution of controlled light in all 3-dimensions to put light on both vertical and horizontal planes within the space. Patented lightguide design featuring molecular optics and precision-coupled optic components yield a high efficiency luminaire. In-plane mixing maximizes color uniformity while light emitting area is uniform and diffuse without 'head lighting' from the LED's.

● END CAPS

Stencil Forms include Hub end caps.

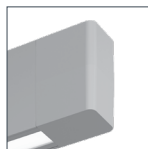

Hub End Cap

● FINISH

Powder coated and custom finishes are also available.

● ACCENT BEAM SPREADS

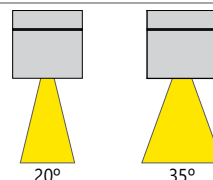

● STENCIL WITH ACCENT SECTION VIEW

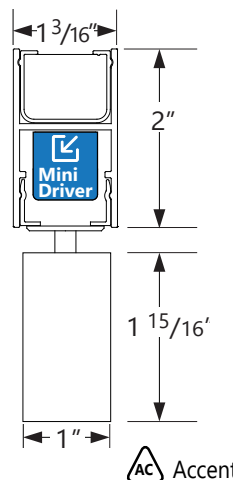

ACCENT EFFICACY

3 Accents / Driver 120V, 21W, 0.18A;
277V, 21.5W, 0.10A.

1 Accent / Driver 120V, 8W, 0.12A;
277V, 8.4W, 0.06A.

NOTE: Configuration of multiple accents with different drivers will change efficacy values.

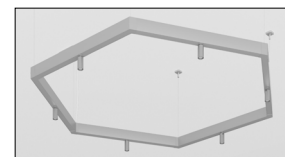

● ACCENT OPTIONS

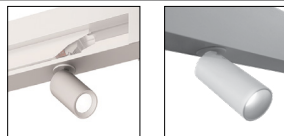

Regular shown

Snoot shown

Accent positioning options.



Accent on segment

● PHOTOMETRIC DATA - DIRECT

200 lm/ft

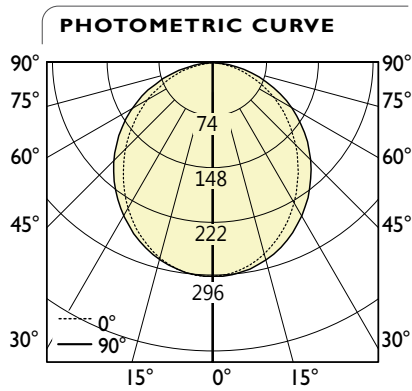

Direct Output: 200 lm/ft
Total Lumens: 781 lm (for 4ft)
Input Watts: 8.5 W
Efficacy: 92 lm/W

80 CRI shown. For 90 CRI, divide wattage by 0.8 and multiply efficacy by 0.8.
 IES FILE: STD-200-80-35-4.IES
 TESTED ACCORDING TO IES LM-79-2008

CANDELA DISTRIBUTION					
Vertical Angle	Horizontal Angles				
	0	22.5	45	67.5	90
0	296	296	296	296	296
5	292	292	293	294	294
15	273	274	277	281	282
25	242	244	250	256	259
35	203	206	215	224	228
45	161	165	176	186	190
55	118	122	133	143	148
65	75	79	89	98	102
75	35	38	45	52	55
85	5	6	8	11	12
90	0	0	0	0	0

ZONAL LUMENS	
Zone	Lumens
0	28
0-10	79
10-20	117
20-30	138
30-40	139
40-50	123
50-60	92
60-70	52
70-80	13
80-90	
90	

LUMINANCE DATA (cd/m ²)			
Vertical Angle	Horizontal Angles		
	0	45	90
45	20504	22389	24210
55	18510	20928	23220
65	16045	18879	21798
75	12317	15483	18962
85	5579	8576	12605

i All IES files are available for download at: www.axislighting.com

400 lm/ft

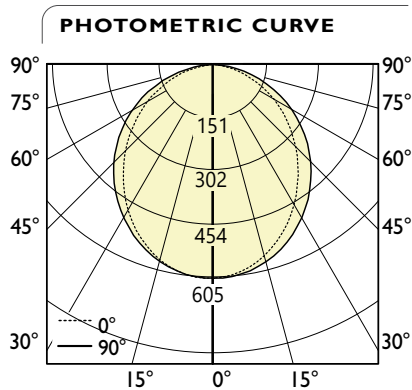

Direct Output: 400 lm/ft
Total Lumens: 1623 lm (for 4ft)
Input Watts: 16.1 W
Efficacy: 101 lm/W

80 CRI shown. For 90 CRI, divide wattage by 0.8 and multiply efficacy by 0.8.
 IES FILE: STD-400-80-35-4.IES
 TESTED ACCORDING TO IES LM-79-2008

CANDELA DISTRIBUTION					
Vertical Angle	Horizontal Angles				
	0	22.5	45	67.5	90
0	613	613	613	613	613
5	605	606	607	609	610
15	566	569	575	581	585
25	502	506	519	531	537
35	421	428	447	465	473
45	333	342	365	386	395
55	244	253	277	298	308
65	156	163	184	205	213
75	73	79	93	107	114
85	11	13	17	23	26
90	0	0	0	1	0

ZONAL LUMENS	
Zone	Lumens
0	58
0-10	164
10-20	243
20-30	286
30-40	289
40-50	256
50-60	192
60-70	108
70-80	28
80-90	
90	

LUMINANCE DATA (cd/m ²)			
Vertical Angle	Horizontal Angles		
	0	45	90
45	42459	46496	50330
55	38355	43489	48309
65	33241	39292	45280
75	25434	32219	39630
85	11262	17772	26347

i All IES files are available for download at: www.axislighting.com

● PHOTOMETRIC DATA - ACCENTS

Accent 20 degree

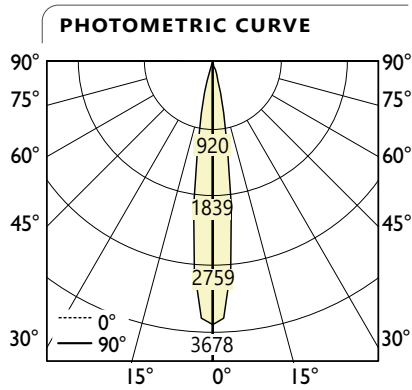

Total Lumens: 391 lm (for 1 accent)
Input Watts: 7.9 W
Efficacy: 49 lm/W

80 CRI shown. For 90 CRI, divide wattage by 0.8 and multiply efficacy by 0.8.
 IES FILE: Stencil-AC-D20(A17399G-20 DG).IES
 TESTED ACCORDING TO IES LM-79-2008

Vertical Angle	Horizontal Angles				
	0	22.5	45	67.5	90
0	3605	3605	3605	3605	3605
5	2668	2516	1376	2760	2863
15	398	366	183	405	422
25	50	48	23	57	53
35	12	11	5	12	12
45	6	6	3	6	6
55	4	4	2	4	4
65	3	3	1	3	3
75	1	1	0	1	1
85	0	0	0	0	0
90	0	0	0	0	0

Zone	Lumens
	0
0-10	131
10-20	29
20-30	8
30-40	4
40-50	4
50-60	3
60-70	1
70-80	0
80-90	0
90	0

Vertical Angle	Horizontal Angles		
	0	45	90
45	16184	7724	16550
55	14208	6951	14208
65	12306	6360	13742
75	5358	3013	6027
85	1986	1005	5958

i All IES files are available for download at: www.axislighting.com

Accent 35 degree

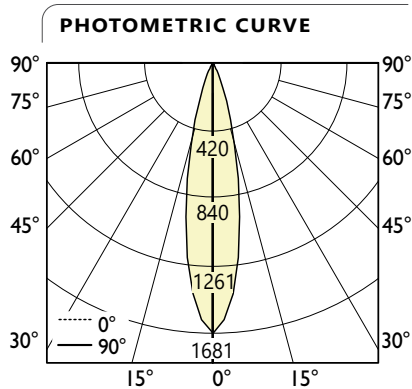

Total Lumens: 355 lm (for 1 accent)
Input Watts: 6.8 W
Efficacy: 52 lm/W

80 CRI shown. For 90 CRI, divide wattage by 0.8 and multiply efficacy by 0.8.
 IES FILE: Stencil-AC-D35(A18322G-35 DG).IES
 TESTED ACCORDING TO IES LM-79-2008

Vertical Angle	Horizontal Angles				
	0	22.5	45	67.5	90
0	1681	1681	1681	1681	1681
5	1442	1453	1453	1455	1453
15	527	518	518	512	506
25	110	109	112	108	105
35	25	25	25	25	24
45	9	9	9	9	9
55	5	5	5	5	5
65	3	3	3	3	3
75	1	1	1	1	1
85	0	0	0	0	0
90	0	0	0	0	0

Zone	Lumens
	0
0-10	145
10-20	55
20-30	17
30-40	7
40-50	5
50-60	3
60-70	1
70-80	0
80-90	0
90	0

Vertical Angle	Horizontal Angles		
	0	45	90
45	30812	31571	30121
55	21803	22482	21803
65	15718	15604	16184
75	4908	4908	5289
85	2236	1684	2236

i All IES files are available for download at: www.axislighting.com

● PHOTOMETRIC DATA - INDIRECT

700 lm/ft

PHOTOMETRIC CURVE

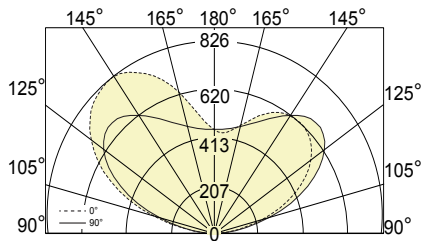

Indirect Output: 700 lm/ft
Total Lumens: 2691 lm (for 4ft)
Input Watts: 31 W
Efficacy: 87 lm/W

80 CRI shown. For 90 CRI, divide wattage by 0.8 and multiply efficacy by 0.8.
 IES FILE: STI-700-80-35-4.IES
 TESTED ACCORDING TO IES LM-79-2008

CANDELA DISTRIBUTION

Vertical Angle	Horizontal Angles								
	0	22.5	45	67.5	90	112.5	135	157.5	180
90	0	0	0	0	0	0	0	0	0
95	25	26	32	42	54	65	53	41	34
105	226	211	194	215	267	265	255	278	285
115	418	391	360	394	481	472	470	520	534
125	551	520	481	518	628	639	648	695	699
135	615	585	548	572	672	732	762	795	794
145	618	595	562	554	619	719	789	823	820
155	568	548	516	498	534	627	704	748	757
165	482	469	454	451	475	529	578	620	626
175	434	433	434	438	449	465	476	483	483
180	446	446	446	446	446	446	446	446	446

ZONAL LUMENS

Zone	Lumens
90	
90-100	57
100-110	256
110-120	438
120-130	529
130-140	517
140-150	421
150-160	281
160-170	148
170-180	44
180	

i All IES files are available for download at: www.axislighting.com

● PHOTOMETRIC DATA - INDIRECT

800 lm/ft

PHOTOMETRIC CURVE

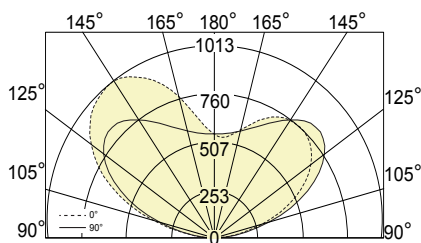

Indirect Output: 800 lm/ft
Total Lumens: 3308 lm (for 4ft)
Input Watts: 38.6 W
Efficacy: 86 lm/W

80 CRI shown. For 90 CRI, divide wattage by 0.8 and multiply efficacy by 0.8.
 IES FILE: STI-800-80-35-4.IES
 TESTED ACCORDING TO IES LM-79-2008

CANDELA DISTRIBUTION

Vertical Angle	Horizontal Angles								
	0	22.5	45	67.5	90	112.5	135	157.5	180
90	0	0	0	0	0	0	0	0	0
95	61	59	61	61	67	68	42	24	18
105	319	295	263	279	329	308	283	294	299
115	547	510	462	498	592	564	551	602	617
125	697	657	605	649	774	774	777	831	834
135	764	725	679	712	832	898	928	966	962
145	755	726	686	683	771	897	977	1012	1006
155	683	659	622	610	670	794	889	939	947
165	575	562	549	555	597	672	738	792	798
175	532	533	537	546	564	587	604	612	612
180	560	560	560	560	560	560	560	560	560

ZONAL LUMENS

Zone	Lumens
90	
90-100	69
100-110	311
110-120	536
120-130	649
130-140	636
140-150	519
150-160	348
160-170	184
170-180	55
180	

i All IES files are available for download at: www.axislighting.com

● PHOTOMETRIC DATA - INDIRECT - ASYMMETRIC

1000 lm/ft

PHOTOMETRIC CURVE

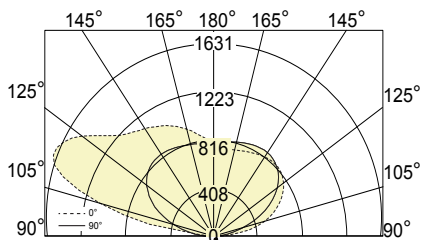

Lumen/ft up: 1000 lm/ft
Total Lumens: 4300 lm (for 4ft)
Input Watts: 47.7 W
Efficacy: 90 lm/W

80 CRI shown. For 90 CRI, divide wattage by 0.8 and multiply efficacy by 0.8.
 IES FILE: STIA-1000-80-35-AS-4.IES
 TESTED ACCORDING TO IES LM-79-2008

CANDELA DISTRIBUTION

Vertical Angle	Horizontal Angles								
	0	22.5	45	67.5	90	112.5	135	157.5	180
90	0	0	0	0	0	0	0	0	0
95	125	18	24	41	30	63	33	23	20
105	479	351	331	299	263	356	605	1034	1088
115	673	597	563	534	523	604	801	1385	1631
125	789	752	719	707	717	792	925	1265	1484
135	837	833	801	801	828	896	996	1140	1217
145	823	844	826	832	868	935	1010	1087	1114
155	789	822	814	824	857	917	978	1025	1039
165	760	791	792	802	827	863	902	931	940
175	768	781	784	790	800	812	822	831	834
180	794	794	794	794	794	794	794	794	794

ZONAL LUMENS

Zone	Lumens
90	
90-100	159
100-110	575
110-120	777
120-130	788
130-140	706
140-150	573
150-160	408
160-170	237
170-180	77
180	

i All IES files are available for download at: www.axislighting.com

● PHOTOMETRIC DATA - MikroLite 1.0

MikroLite - 35° beam



PHOTOMETRIC CURVE

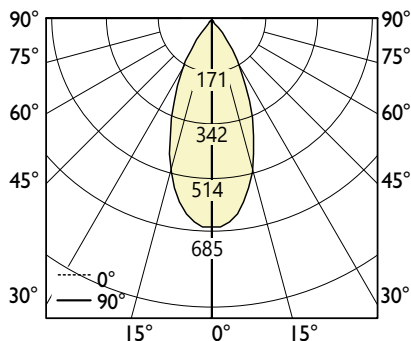

Total Lumens: 452 lm (for 1 module)
Input Watts: 6.59 W
Efficacy: 69 lm/W

80 CRI shown. For 90 CRI, divide wattage by 0.8 and multiply efficacy by 0.8.
 IES FILE: MKL-D35-A18323G.IES
 TESTED ACCORDING TO IES LM-79-2008

CANDELA DISTRIBUTION

Vertical Angle	Horizontal Angles				
	0	22.5	45	67.5	90
0	685	685	685	685	685
5	664	665	666	667	666
15	514	517	522	521	520
25	292	297	305	301	296
35	119	132	142	132	117
45	15	27	50	27	14
55	2	3	4	3	3
65	0	0	0	0	0
75	0	0	0	0	0
85	0	0	0	0	0
90	0	0	0	0	0

ZONAL LUMENS

Zone	Lumens
0	
0-10	62
10-20	143
20-30	137
30-40	82
40-50	25
50-60	4
60-70	0
70-80	0
80-90	0
90	

LUMINANCE DATA (cd/m²)

Vertical Angle	Horizontal Angles		
	0	45	90
45	10042	34267	9679
55	2064	3662	2476
65	0	0	0
75	0	0	0
85	0	0	0

i All IES files are available for download at: www.axislighting.com

● PHOTOMETRIC DATA - MikroLite 1.0

MikroLite - 20° beam

CANDELA DISTRIBUTION

Vertical Angle	Horizontal Angles				
	0	22.5	45	67.5	90
0	1993	1993	1993	1993	1993
5	1859	1830	1831	1837	1835
15	858	863	861	828	843
25	286	288	294	273	266
35	76	88	102	89	71
45	9	15	32	15	9
55	1	1	3	1	1
65	0	0	0	0	0
75	0	0	0	0	0
85	0	0	0	0	0
90	0	0	0	0	0

ZONAL LUMENS

Zone	Lumens
0	
0-10	159
10-20	225
20-30	122
30-40	49
40-50	13
50-60	2
60-70	0
70-80	0
80-90	0
90	

LUMINANCE DATA (cd/m²)

Vertical Angle	Horizontal Angles		
	0	45	90
45	192	452	113
55	22	37	14
65	0	1	1
75	0	0	0
85	0	0	0

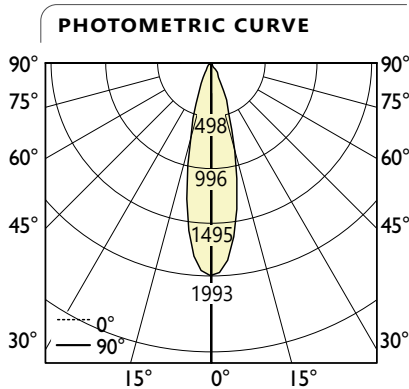

Total Lumens: 569 lm (for 1 module)
Input Watts: 6.6 W
Efficacy: 86 lm/W

80 CRI shown. For 90 CRI, divide wattage by 0.8 and multiply efficacy by 0.8.
 IES FILE: MKL-D20-A18324G.IES
 TESTED ACCORDING TO IES LM-79-2008

 All IES files are available for download at: www.axislighting.com