

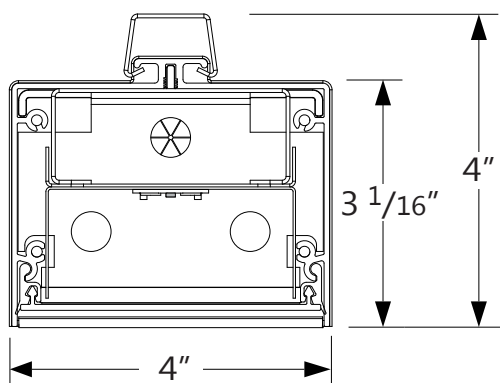

Project _____

Type _____

Notes _____



PERFORMANCE PER LINEAR FOOT AT 3500K

NOMINAL LUMEN OUTPUT	INPUT WATTS*	EFFICACY
500 lm/ft	5.5 W/ft	91 lm/W
900 lm/ft	9.9 W/ft	91 lm/W

Please consult factory for custom lumen output and wattage.



cULus Listed
Type I.C.



Ordering Guide

WBSLED		NOM.LUMENS/FT		CRI		COLOR TEMP.		S		LENGTH (FT)	
PRODUCT ID		500	900	80	90	27	30	35	40	S	
Surface LED		500 lm/ft - Min.	900 lm/ft - Max.	80 CRI	90 CRI	2700 K	3000 K	3500 K	4000 K	S satin lens	2 2'
											3 3'
											4 4'
											5 5'
											8 8'
											S# system run
		Outputs between listed min and max are available. Consult factory for outputs outside of the listed range.									

FINISH		VOLTAGE		DRIVER		CIRCUITS		MOUNTING/SUSPENSION	
AP	aluminum paint	120	120 V	DP	dimming (0-10V) 1%	1	1 circuit	SC	surface solid ceiling
W	white	277	277 V	LT(#)	Lutron *	2	2 circuits		
BLK	black	347	347 V	BI	bi-level dimming	+E(#)	emergency circuit *		
C	custom	UNV	universal	O(#)	other **	+NL(#)	night light circuit *		
		DC	low voltage*	POE(#)	POE drivers*	+GTD(#)	generator transfer device *		
		* Only available with POE drivers.		* Operating up to -20°C; Specify system ** Please consult factory; see page 2		* Specify quantity			

BATTERY (OPTIONAL)		OTHER (OPTIONAL)		IC CONTROLS (OPTIONAL)		CUSTOM (OPTIONAL)	
B#	battery pack (integral)	F	fuse ⁽⁴⁾	OS#	occupancy sensor	C	custom
		EF	end feed*	EN	Enlighted integral	N	natatorium finish
				WC#	wireless control dimming		
Not available with 347V Please consult factory		(4) Requires 120V or 277V; * See page 2 for more details.		See integrated controls guide for further details Please consult factory		Please specify	

● **MOUNTING OPTIONS**

SC SURFACE SOLID CEILING

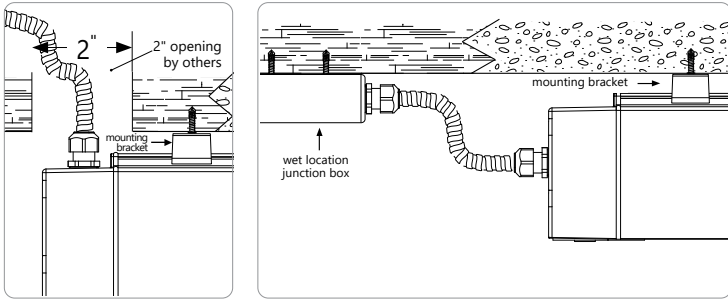

Power top feed

Power end feed

● **OTHER MOUNTING OPTIONS**

WET BEAM 4 LED is available with recessed horizontal, recessed vertical, pendant, and wall mounted options.

● **CONSTRUCTION**

Housing	Extruded Aluminum (0.062" nominal) Up to 70% Recycled Content
End Cap	Die Cast Zinc (0.070" nominal)
Interior Brackets	Die Formed Sheet Steel (16 gauge)
Gaskets	Moulded Elastomer (0.100" nominal)
Lens Gaskets	Extruded Elastomer (0.045" nominal)
Satin Lens	Extruded Polycarbonate

● **ELECTRICAL**

Lutron driver*	LDE1 - Hi-lume 1% EcoSystem with Soft-on, Fade-to-Black LTEA - Hi-lume 1% 2-wire (120V forward phase only) *Consult factory
Other drivers**	DALI - Digital Addressable Lighting Interface DMX - Digital Multiplex LV - line voltage - Advance Mark 10 Xitanium SR - For wireless sensor
Power over Ethernet POE drivers*	MOLEX IGOR O - Other (Consult factory)
Emergency	Integral emergency battery pack or emergency circuit optional.
Input Voltage	120V, 277V, 347V, UNV.

i Incorporating these components may have limitations or affect the length of the luminaire. Please contact factory for more details.

● **LED SYSTEM**

CRI	Minimum 80 or 90 color rendering index.
CCT	Choice of 2700K, 3000K, 3500K and 4000K color temperature with a great color consistency (within 3-step MacAdam ellipse). Both within fixture and fixture to fixture.
LED life	Minimum 50,000h with 85% of lumen maintenance in 25°C ambient temperature, in compliance with IES LM-80 testing measurements.
Thermal Management	Aluminum housing acting as the heat sink to maximize life.

i Row configuration, specification sheets and mounting spacing guides are available for download at: www.axislighting.com

● **OPTICS**

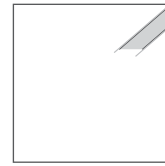

SATIN LENS
Extruded Polycarbonate

S satin lens

● **WEIGHT**

Surface 4 ft	12.8 lbs / 5.8 kg
Surface 8 ft	24.5 lbs / 11.1 kg

● **GASKETTED FIXTURE**

With its gasketed end cap and lens the Wet BEAM 4 LED is made for wet locations, and is ideal for exterior soffits and canopies of malls, hospitals and other institutions.

● **JOINER SYSTEM**

Wet BEAM 4 modular system consists of smaller modules joined and gasketed together allowing for system runs in lengths of 4' and 8' as well as custom lengths up to 12'.

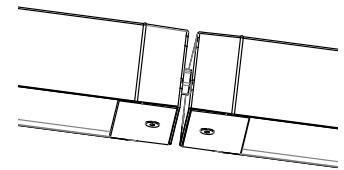

* For continuous rows allow 2" for connectors between each fixture.

● **POWER FEED**

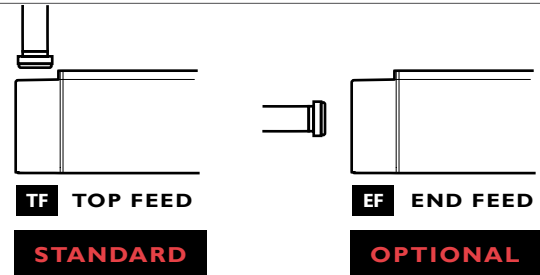

* Not available with 347 V.

● **FINISH**

Powder coated and custom finishes are also available.

● **APPROVALS**

Certified wet locations to UL and CSA standards

● **WARRANTY**

Axis Lighting will warrant defective LEDs, boards, and drivers for 5 years from date of purchase. Warranty is valid if luminaire is installed and used according to specifications. If defective, Axis will send replacement boards or drivers at no cost along with detailed replacement instructions and instructions on how to return defective components to Axis.

● PHOTOMETRIC DATA

500 lm/ft

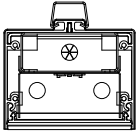

PHOTOMETRIC CURVE

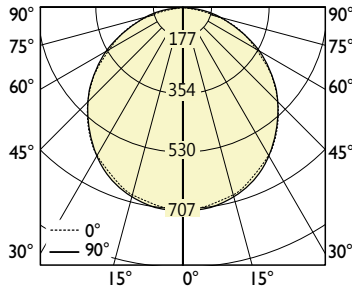

Luminaire Lumens: 500 lm/ft
Input Watts: 5.5 W/ft
Efficacy: 91 lm/W
 IES FILE: WBSLED-500-80-35-S.IES

TESTED ACCORDING TO IES LM-79-2008

CANDELA DISTRIBUTION

Vertical Angle	Horizontal Angles				
	0	22.5	45	67.5	90
0	704	704	704	704	704
5	697	701	700	703	706
15	672	677	677	679	682
25	623	626	627	628	631
35	552	555	555	554	555
45	465	466	466	465	465
55	363	365	364	362	361
65	249	250	249	246	244
75	129	130	126	123	121
85	29	25	20	17	16
90	0	0	0	0	0

ZONAL LUMENS

Zone	Lumens
0	
0-10	67
10-20	191
20-30	289
30-40	347
40-50	359
50-60	324
60-70	245
70-80	133
80-90	28
90	

LUMINANCE DATA (cd/m²)

Vertical Angle	Horizontal Angles		
	0	45	90
45	5567	5579	5567
55	5357	5372	5328
65	4987	4987	4887
75	4219	4121	3957
85	2817	1942	1554

750 lm/ft

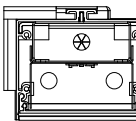

PHOTOMETRIC CURVE

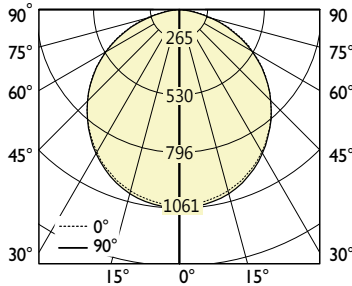

Luminaire Lumens: 750 lm/ft
Input Watts: 8.3 W/ft
Efficacy: 90 lm/W
 IES FILE: WBSLED-750-80-35-S.IES

TESTED ACCORDING TO IES LM-79-2008

CANDELA DISTRIBUTION

Vertical Angle	Horizontal Angles				
	0	22.5	45	67.5	90
0	1056	1056	1056	1056	1056
5	1046	1052	1050	1055	1059
15	1008	1016	1016	1019	1023
25	935	939	941	942	947
35	828	833	833	831	833
45	698	699	699	698	698
55	545	548	546	543	542
65	374	375	374	369	366
75	194	195	189	185	182
85	44	38	30	26	24
90	0	0	0	0	0

ZONAL LUMENS

Zone	Lumens
0	
0-10	100
10-20	287
20-30	433
30-40	520
40-50	539
50-60	486
60-70	368
70-80	200
80-90	43
90	

LUMINANCE DATA (cd/m²)

Vertical Angle	Horizontal Angles		
	0	45	90
45	8350	8368	8350
55	8036	8058	7992
65	7481	7481	7331
75	6329	6181	5936
85	4225	2914	2331

i All IES files are available for download at: www.axislighting.com

● PHOTOMETRIC DATA

900 lm/ft

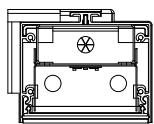

PHOTOMETRIC CURVE

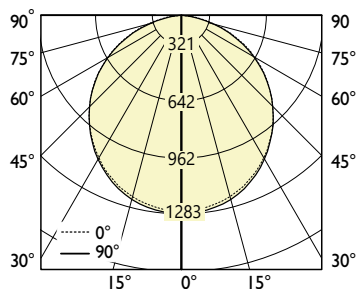

Luminaire Lumens: 900 lm/ft
Input Watts: 9.9 W/ft
Efficacy: 91 lm/W

IES FILE: WBSLED-900-80-35-S.IES

TESTED ACCORDING TO IES LM-79-2008

CANDELA DISTRIBUTION

Vertical Angle	Horizontal Angles				
	0	22.5	45	67.5	90
0	1278	1278	1278	1278	1278
5	1265	1272	1271	1276	1281
15	1220	1229	1229	1232	1238
25	1131	1136	1138	1140	1145
35	1002	1007	1007	1006	1007
45	844	846	846	844	844
55	659	662	661	657	655
65	452	454	452	446	443
75	234	236	229	223	220
85	53	45	36	31	29
90	0	0	0	0	0

ZONAL LUMENS

Zone	Lumens
0	
0-10	121
10-20	347
20-30	524
30-40	629
40-50	652
50-60	589
60-70	445
70-80	242
80-90	52
90	

LUMINANCE DATA (cd/m²)

Vertical Angle	Horizontal Angles		
	0	45	90
45	10104	10125	10104
55	9723	9750	9670
65	9052	9052	8870
75	7658	7480	7183
85	5112	3526	2821

i All IES files are available for download at: www.axislighting.com