

# 8317H

120V

Catalog #:		Type
Project:		Date
Prepared by:		

## 3" LED IC Rated Frame-In



*Pictured with trim option*

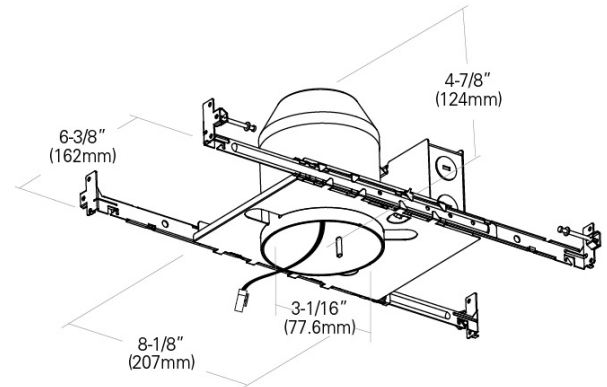

3" LED Non-IC Frame-In

### DESCRIPTION

An ideal solution for efficiency, and flexible design aesthetics. Designed for use in shallow ceiling applications with 2x6 ceiling joist. Balances efficiency and cost to bring you the options needed to complete a variety of residential or commercial projects with a reliable and modern LED down light solution.

### DESIGN FEATURES

#### Electrical

- 10-100% TRIAC dimmable for most of leading and trailing edge LED, incandescent & low voltage dimmer switches

#### Housing

- Sturdy steel construction
- Suitable for use in new construction applications
- 4-7/8" height allows use in 2" x 6" joist construction
- Adjusts to accommodate up to 1-1/4" ceiling thickness
- IC Rated for direct contact with insulation

#### Junction Box

- J-Box is listed for through-branch circuit wiring (4in - 4out) and five 1/2" knockouts
- 3 port quick connectors pre-installed in all J-boxes

#### Bar Hanger

- Included bar hangers can be turned 90° on the plaster frame
- Bar hangers are designed to fit T-bar spine without additional clamps for use in drop ceilings
- Pre-installed captive nails on bar hangers
- Pre-installed bar hangers allow the housing to be positioned at any point within 24" joist span

#### Dimensions

- Size: H 4-7/8" x L 8-1/8" x W 3-1/16"
- Aperture: 3-1/16"

#### Certifications

- cCSAus listed for damp locations
- Energy Star approved & listed for trims 8824 & 8825
- 5 year limited warranty



TEL: 800.937.6925 | Fax: 800.207.9509 | [www.rplighting.com](http://www.rplighting.com)

Specifications and dimensions subject to change without notice.

# 8317H

120V

## Trim Ordering

### HOUSING

Example: 8317H

Housing #		
	8317H	
	8317H 120V	4-7/8" H X 8-1/8" L x 6-3/8" W Aperture: 3-5/16"

### MODULE/TRIM

Example: 8821WH-3K

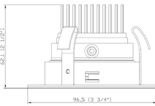
Module/Trim #		Finish	CCT
 	8821		
	8821 3" Recessed Baffle 8W   600lms   90CRI	<b>WH</b> : White <b>BN</b> : Brushed Nickel <b>OB</b> : Oil Rubbed Bronze	<b>-3K</b> : 3000K

### MODULE/TRIM

Example: 8822-1-WH-3K

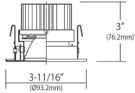
Module/Trim #		Finish	CCT
 	8822-1		
	8822-1 3" Recessed Baffle 10W   650lms   80CRI	<b>WH</b> : White <b>BN</b> : Brushed Nickel <b>OB</b> : Oil Rubbed Bronze	<b>-3K</b> : 3000K

### MODULE/TRIM

Example: 8822WH-3K

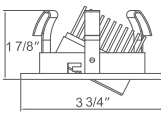
Module/Trim #		Finish	CCT
 	8822		
	8822 3" Recessed Gimbal 8W   600lms   90CRI	<b>WH</b> : White <b>BN</b> : Brushed Nickel <b>OB</b> : Oil Rubbed Bronze	<b>-3K</b> : 3000K



### MODULE/TRIM

Example: 8824-WH-90-3K

Module/Trim #		Finish	Color Rendering	CCT
 	8824			
	 <b>8824</b> LED Retrofit Baffle 10W   600lms	<b>WH</b> : White	<b>-90</b> : 90CRI	<b>-3K</b> : 3000K

### MODULE/TRIM

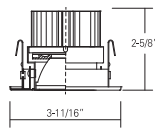
Example: 8825-WH-90-3K

Module/Trim #		Finish	Color Rendering	CCT
 	8825			
	 <b>8825</b> LED Retrofit Gimbal 10W   600lms	<b>WH</b> : White	<b>-90</b> : 90CRI	<b>-3K</b> : 3000K

TEL: 800.937.6925 | Fax: 800.207.9509 | [www.rplighting.com](http://www.rplighting.com)

Specifications and dimensions subject to change without notice.