

8102HRA

120V-60Hz

Catalog #:		Type
Project:		Date
Prepared by:		

6" IC Airtight Remodel

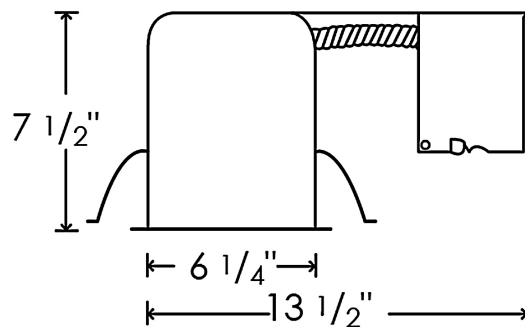

6" IC Airtight Remodel

DESCRIPTION

An ideal solution for housing that will be in direct contact with insulation. The 8102HRA balances power, efficiency and cost to bring you the options needed to complete a variety of residential or commercial projects with a reliable and modern down light solution.

DESIGN FEATURES

Electrical

- 120V
- Incandescent, 75W Max

Housing

- IC Rated for direct contact with batt type fiberglass insulation
- Thermally protected against improper lamping
- 7-1/2" height allows use in 2" x 8" joist construction
- Adjustable socket bracket plate for proper positioning of different lamp types
- Adjusts to accommodate various ceiling thicknesses
- cETLus listed for damp location and feed through wiring

Junction Box

- J-box is listed for through-branch circuit wiring (4in – 4out), with eight 1/2" knockouts and four non-metallic cable knockouts with strain clamps
- 3-port quick connectors pre-installed in all J-boxes

Dimensions

- H 7-1/2" x L 13-1/2" x W 7"
- Aperture: 6-1/4"

Certifications

- Meets Washington's State energy code for restricted airflow
- cETLus certified for damp location and feed through wiring
- 1 year limited warranty

Lamp

- A19
- PAR30/38
- BR30/40
- LED retro



8102HRA

120V-60Hz

Specification & Ordering

HOUSING

Example: 8201HRA

Housing #	Wattage
 8201HRA	
8201HRA	50 Max (trim Permitting)

LED Trims

MODULE/TRIM

Example: 8523WH-12.5-90-3K

Module/Trim #	Finish	Watt/Lms	CRI	CCT
 8523				
8523 5/6" LED Baffle	WH : White BK : Black OB : Oil Rubbed Bronze BN : Brushed Nickel	-12.5 : 12.5W, 850lms	-90 : 90 CRI	-3K : 3000K -4K : 4000K

MODULE/TRIM

Example: 8538WH-R-15-90-3K

Module/Trim #	Finish	Watt/Lms	CRI	CCT
 8538-R				
8538-R LED Disk Light	WH : White BK : Black OB : Oil Rubbed Bronze BN : Brushed Nickel	-15 : 15W, 850lms	-90 : 90 CRI	-3K : 3000K -4K : 4000K

MODULE/TRIM

Example: 8569WH-R-15-84-3K

Module/Trim #	Finish	Watt/Lms	CRI	CCT
 8569-R				
8569-R LED Disk Light	WH : White OB : Oil Rubbed Bronze BN : Brushed Nickel	-15 : 15W, 1240lms	-84 : 84 CRI	-3K : 3000K -4K : 4000K

MODULE/TRIM

Example: 8556WH-R-15-90-3K

Module/Trim #	Finish	Watt/Lms	CRI	CCT
 8556-R				
8556-R LED Retrofit Disk	WH : White BK : Black OB : Oil Rubbed Bronze BN : Brushed Nickel	-15 : 15W, 1000lms	-90 : 90 CRI	-27K : 2700K -3K : 3000K -4K : 4000K -5K : 5000K

TEL: 800.937.6925 | Fax: 800.207.9509 | www.rplighting.com

Specifications and dimensions subject to change without notice.

10/2/2020 R1



RP | LIGHTING · FANS

8102HRA

120V-60Hz

Specification & Ordering

MODULE/TRIM

Example: 8538WH-13-80-3K

Module/Trim #	Finish	Watt/Lms	CRI	CCT
	8562			
	8562 LED Retrofit Gimbal WH : White BK : Black OB : Oil Rubbed Bronze BN : Brushed Nickel	-13 : 13W, 900lms	-80 : 80 CRI	-3K : 3000K

MODULE/TRIM

Example: 8563WH-15-90-3K

Module/Trim #	Finish	Watt/Lms	CRI	CCT
	8563			
	8563 LED Retrofit WH : White BK : Black OB : Oil Rubbed Bronze BN : Brushed Nickel CL : Clear	-15 : 15W, 765lms	-80 : 80 CRI -90 : 90 CRI	-3K : 3000K -4K : 4000K

MODULE/TRIM

Example: 8564WH-12-90-3K

Module/Trim #	Finish	Watt/Lms	CRI	CCT
	8564			
	8564 LED Retrofit Eyeball WH : White OB : Oil Rubbed Bronze BN : Brushed Nickel	-12 : 12W, 900lms	-90 : 90 CRI	-3K : 3000K

MODULE/TRIM

Example: 8565OB-15-90-3K

Module/Trim #	Finish	Watt/Lms	CRI	CCT
	8565			
	8565 LED Retrofit Baffle OB : Oil Rubbed Bronze BN : Brushed Nickel	-15 : 15W, 1200lms	-90 : 90 CRI	-3K : 3000K

MODULE/TRIM

Example: 8566WH-15-90-3K

Module/Trim #	Finish	Watt/Lms	CRI	CCT
	8566			
	8566 LED Retrofit Gimbal WH : White OB : Oil Rubbed Bronze BN : Brushed Nickel	-15 : 15W, 1200lms	-90 : 90 CRI	-3K : 3000K

TEL: 800.937.6925 | Fax: 800.207.9509 | www.rplighting.com

Specifications and dimensions subject to change without notice.

10/2/2020 R1

8102HRA

120V-60Hz

Specification & Ordering

MODULE/TRIM

Example: 8567WH-15-90-3K

Module/Trim #	Finish	Watt/Lms	CRI	CCT
	8567			
	8567 LED Retrofit Eyeball WH : White OB : Oil Rubbed Bronze BN : Brushed Nickel	-15 : 15W, 1200lms	-90 : 90 CRI	-3K : 3000K

ORDERING GUIDE

Example: 8568WH-90-3K

Model #	Finish	CRI	CCT
	8568	-90	
	8568 6" LED Baffle Trim with Lens; 17W, 1240 lms BK : Black OB : Oil Rubbed Bronze CL : Clear WH : White	-90 : 90 CRI	-3K : 3000K* -4K : 4000K

* Not available in Clear (CL)

Incandescent Trims

MODULE/TRIM

Example: 8502FS

Module/Trim #	Finish
	
	8502 Shower trim with Lexan fresnel lens, 60W Max. A19 FS : Fresnel FS-BN : FS-M :

MODULE/TRIM

Example: 8518CL

Module/Trim #	Finish
	
	8518 Specular Clear Reflector 100W Max. A19 23W Max. CFL CL : Clear

MODULE/TRIM

Example: 8518WH

Module/Trim #	Finish
	
	8518 Specular White Reflector 100W Max. A19 WH : White

8102HRA

120V-60Hz

Specification & Ordering

Incandescent Trims

MODULE/TRIM

Example: 8504BK

Module/Trim #	Finish
 <p>8504 Black Baffle 75W Max. PAR30/BR30</p>	BK : Black

MODULE/TRIM

Example: 8505AL

Module/Trim #	Finish
 <p>8505 Shower Trim with Lexan, flat opal albalite lens 60W Max. A19</p>	AL : Albalite AL-BR : AL-M :

MODULE/TRIM

Example: 8519BK

Module/Trim #	Finish
 <p>8519 Airtight Cone White Baffle, 150W Max. PAR30/BR30/A19 PAR38/BR40</p>	WH : White BK : Black

MODULE/TRIM

Example: 8509DR

Module/Trim #	Finish
 <p>8509 Shower trim with Lexan drop opal lens and plastic ring, 60W Max. A19</p>	DR : Drop Opal DR-BR : DR-M :

MODULE/TRIM

Example: 8511WH

Module/Trim #	Finish
 <p>8511 White Baffle 75W Max. PAR30/BR30</p>	WH : White

6" IC Airtight Remodel