

STARLINE[®] MICRO MD - MICRO/R - PIKO/R
RECESSED LUMINAIRES

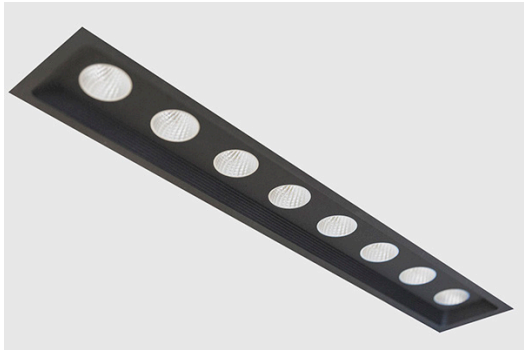

Waldmann Lighting's STARLINE MICRO MD recessed luminaire series brings style and sophistication to any room starting at the top. The small, unassuming form factor fits easily into any drop ceiling and from there, the only limits are the imagination. With an impressive array of size, shape and technical options, STARLINE MICRO MD can be customized to obtain the desired effect subtly and beautifully.

With various beam angles; circular, square and rectangular shapes; and several sizes and colors, STARLINE MICRO MD is very effective when used as general lighting and accent lighting – always delivering uniform direct illumination without the glare that can accompany it, with an exceptional glare rating as low as UGR<6. And with 50,000 hours of maintenance-free operation, the lights stay on for a long, long time.

STARLINE® MICRO MD recessed luminaires



8 X MD

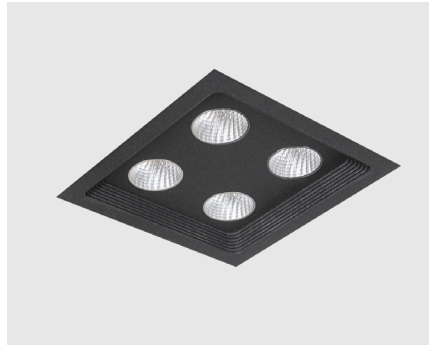

2 X 2 MD



1 X MD



2 X MD



4 X MD

Specifications

Dimensions (L/W/H):

1 x MD - 2.3in. x 2.3in. x 2.4in.
 2 x 2 MD - 3.9in. x 3.9in. x 2.4in.
 2 X MD - 3.9in. x 2.3in. x 2.4in.
 4 x MD - 6.8in. x 2.3in. x 2.4in.
 8 x MD - 13.4in. x 2.3in. x 2.4in.

Finish:

epoxy powder coating

Luminous efficacy:

105 lm/W

Wattage:

5 - 31W

Color temperature:

3000K/ 3500K/ 4000K/ 2700-6500K

Illuminance:

500 - 3100 lumens

Beam Angles:

35° / 55° / 75°

Unified Glare Rating (UGR):

35°<6 / 55°<19 / 75°<25

Color Rendering Index (CRI):

CRI>80

LED service life:

50,000 hours (L70B10)

Remote driver and housing:

120-227V

Controls:

0-10V standard dimming

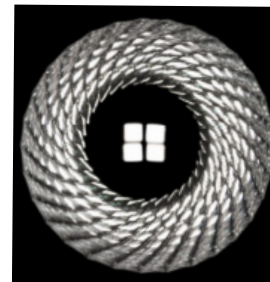
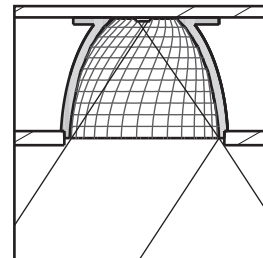

STARLINE®
MD MICRO
DOWNLIGHT OPTIC



STARLINE[®] MICRO/R - PIKO/R recessed luminaires

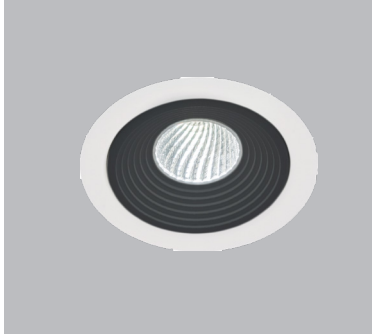

MICRO/R



MICRO/R Specifications

Dimensions (Ø/H):	2.3in. x 3.7in.
Finish:	epoxy powder coating
Luminous efficacy:	105lm/W
Wattage:	5W
Color temperature:	3000K/ 3500K/ 4000K/ 2700-6500K
Illuminance:	500 lumens
Beam Angle:	35° / 55° / 75°
Unified Glare Rating (UGR):	35°<6 / 55°<19 / 75°<25
Color Rendering Index (CRI):	CRI>80
Remote driver and housing:	120-227V
Controls:	0-10V standard dimming

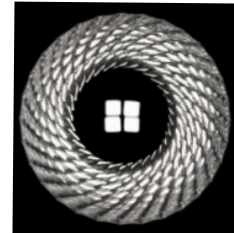
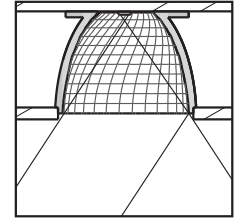

**STARLINE[®]
MD MICRO
DOWNLIGHT OPTIC**

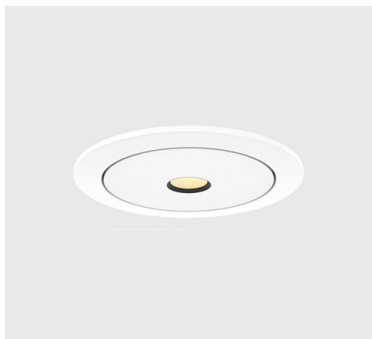

PIKO/R



PIKO/R Specifications

Dimensions (Ø/H):	2.3in. x 3.7in.
Finish:	epoxy powder coating
Luminous efficacy:	55lm/W
Wattage:	5W
Color temperature:	3500K
Illuminance:	240 lumens
Beam Angle:	60°
Unified Glare Rating (UGR):	UGR<16
Color Rendering Index (CRI):	CRI>80
Remote driver and housing:	120-227V
Controls:	0-10V standard dimming

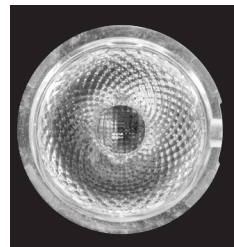
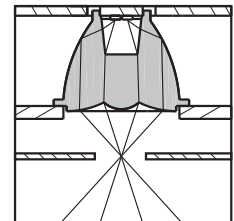

**STARLINE[®]
PIKO OPTIC**

MICRO MD recessed luminaire beam angles



MICRO MD recessed luminaire frame colors

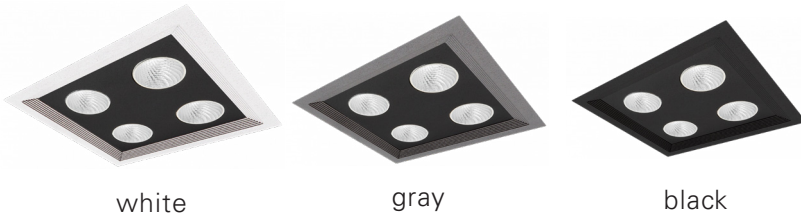

ORDER CONFIGURATOR

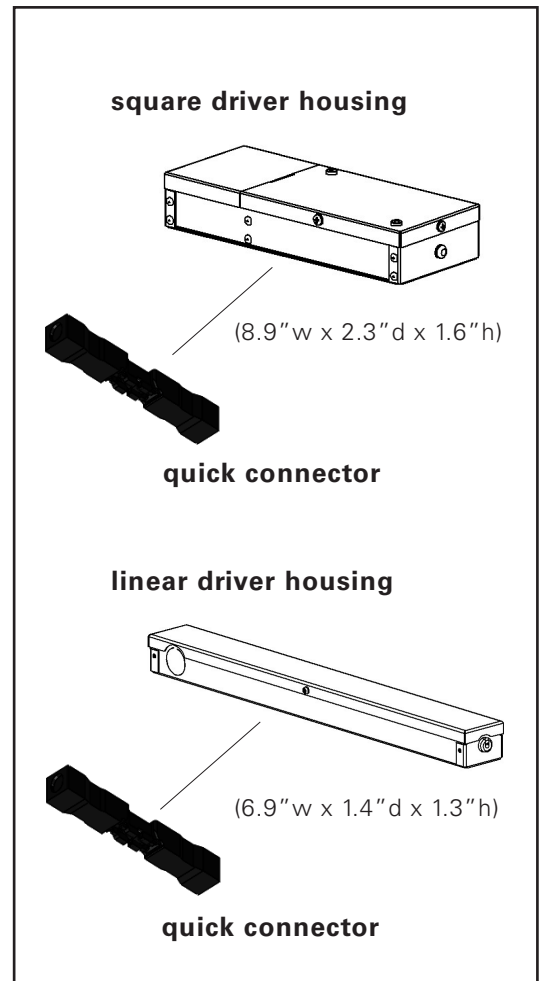
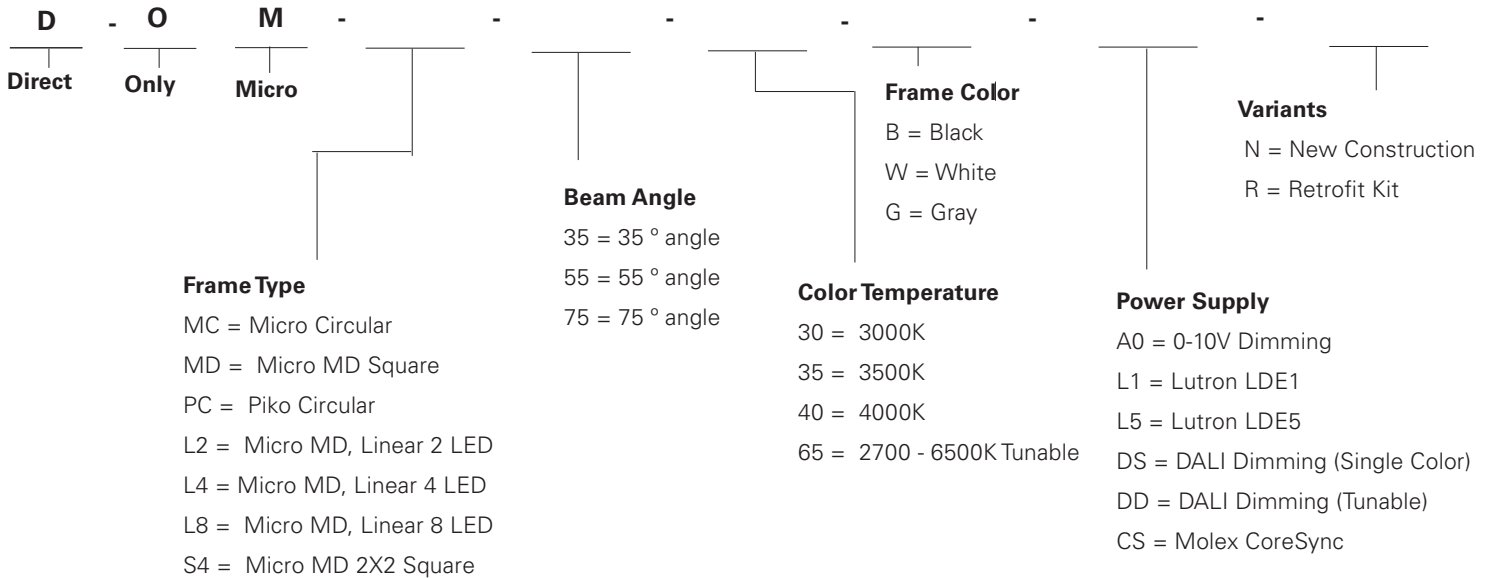

Waldmann Lighting Company

9 Century Drive
Wheeling, Illinois 60090
www.waldmannlighting.com

Telephone (847) 520 1060
Fax (847) 520 1730
waldmann@waldmannlighting.com



ENGINEERS OF LIGHT