

# VEGA 1x4 LED

SURFACE



**LUMENWERX**  
WWW.LUMENWERX.COM

## CHROMAWERX QUADRO - RGBW

**IMPORTANT: a qualified DMX integration consultant is required to ensure proper installation and function of any DMX network**



Shown with MTO and HLO optics

### DESCRIPTION

**Vega** is an efficient architectural LED troffer with a distinctive luminous shielding that features a median textured optic. Using advanced LED engines, Vega provides highly efficient illumination and offers comprehensive ceiling, electrical, and controls options in 2x2, 1x4, and 2x4 sizes. Vega is an ideal vehicle for Chromawerx color tuning in education, office, and healthcare applications where modular luminaires are used. See separate spec sheets for other available mountings.

**PROJECT:** \_\_\_\_\_  
 \_\_\_\_\_  
 \_\_\_\_\_

**APPROVED BY:** \_\_\_\_\_

**SIGNATURE:** \_\_\_\_\_



### ORDER GUIDE

VEGS	14	MTO	HLO	LED		
LUMINAIRE ID	SIZE	CENTER OPTICS	SIDE OPTICS	LIGHT SOURCE	CHROMAWERX	OUTPUT WATTAGE
VEGS - vega surface	14 - 1'x4'	MTO - Median Textured Optic	HLO - High-Efficiency Lambertian Optic	LED - high performance LED	<b>QUADRO</b> - four-channel RGB with 3500K white <b>RS</b> - red solid <b>GS</b> - green solid <b>BS</b> - blue solid	<b>20W</b> - 20 watts output (for solid colors only) <b>20W</b> - 20 watts output (quadro only) <b>25W</b> - 25 watts output (quadro only) <b>30W</b> - 30 watts output (quadro only)

		1	SUR		
VOLTAGE	DRIVER	ELECTRICAL	MOUNTING	FINISH	OPTIONS
120 - 120V 277 - 277V	<b>DMX</b> - to specify see pages 4 to 9 <b>DA</b> - DALI (solid colors only) local on-site commissioning is required <b>O-10</b> - O-10 (solid colors only)	1 - 1 circuit	SUR - surface mount kit	<b>W</b> - matte white <b>CF#</b> - custom finish specify RAL#	<b>FU</b> - fuse <b>CU</b> - custom

### DMX WALL CONTROLS

To specify see pages 4 to 9

See page 2 for ordering code detailed information

### CROSS SECTION

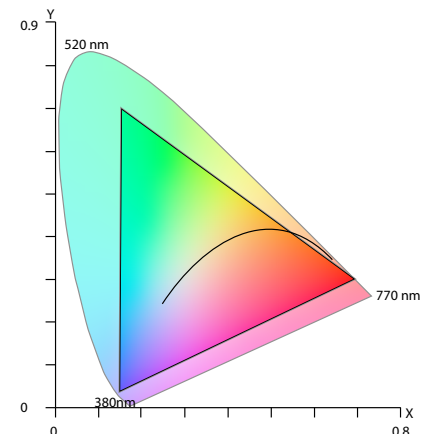
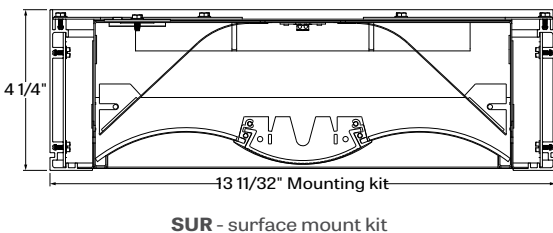

## CHROMAWERX QUADRO - RGBW

### OPTICS

**CENTER LENS - MEDIAN TEXTURED OPTIC (MTO)** - Median Textured Optic (MTO) shielding consisting of ribbed diffusing center element.

**SIDE LENS - HIGH EFFICIENCY LAMBERTIAN OPTIC (HLO)** - Curved sides of diffusing 0.075" thick acrylic with 90% transmission and good source obscuration. Luminaire brightness is controlled by the flux-to-shielding area ratio in addition to offering a gentle gradient from center to edge.

### LIGHT SOURCE - LED

Custom array of mid-flux LEDs, comprised of an alternation of an RGB and a dedicated white LED. The white LED is used for when a static white CCT is required in the space. RGB LEDs are tightly binned for excellent color control between fixtures. The white LEDs have been tested in accordance with IESNA LM-80-08 and the results have shown L80 lumen maintenance greater than 60,000 hours. Absolute product photometry is measured and presented in accordance with IESNA LM-79, unless otherwise indicated.

### CHROMAWERX - RGBW

**Chromawerx Quadro** is a four-channel control that operates an RGBW LED array and addresses the need for more expressive color in architectural applications. The DMX driver supports familiar programming tools for both dynamic multi-hued color and precise white color point control. While a typical user interface will be a DMX controller by others, Lumenwerx also offers a simple control station for stand-alone color changing applications.

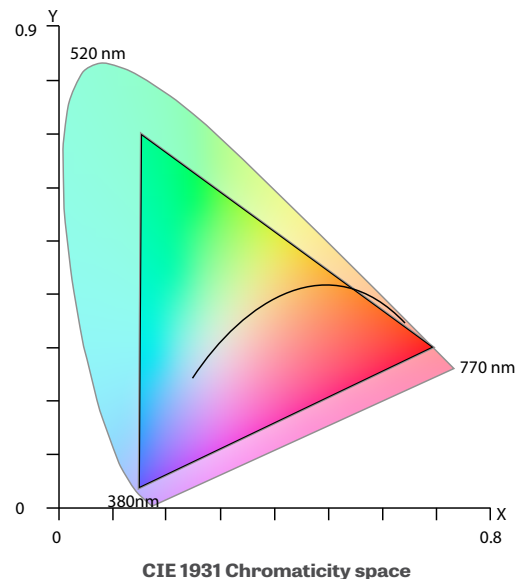

The above diagram overlays the full gamut of colors attainable with the RGBW on top of the CIE 1931 color space. Any color point inside of the triangle can be obtained by setting the correct output levels for each of the individual red, green, blue, and white channels.

### ELECTRICAL

#### DMX

Factory-set, adjustable output current, multi-channel LED driver with universal (120-277VAC) input. Using DMX wall controls (optionally supplied by Lumenwerx) or an existing DMX control system, four channels of LEDs (Red/Green/Blue/White) are independently adjustable. Each DMX driver has multiple output channels that can be independently addressed at the factory or on-site using built-in RDM (Remote Device Management) functionality. Dimming range from 100%-0%. At maximum driver load, efficiency < 89%, PF > 0.9, THD < 20%.

### CHROMAWERX QUADRO - RGBW

#### MOUNTING OPTIONS

A separate kit for mounting fixtures directly to the ceiling surface. Kit is compatible with T-Bar, hard surface and drywall ceilings.

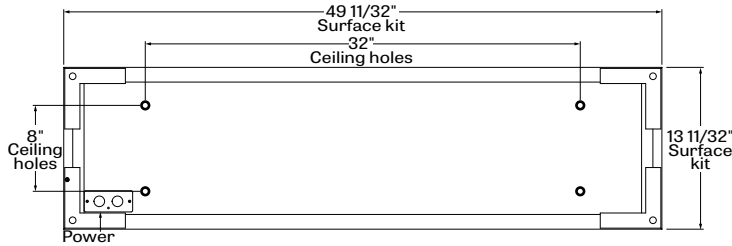

SUR - surface mount kit

#### FINISH

**Interior reflectors** - 95% reflective, matte white powder coating

**Exterior** - matte white powder coating.

Custom finish is also available.

#### CONSTRUCTION

**Housing** - Die formed cold rolled sheet steel 20 gauge thick, matte white powder coating.

**Reflectors** - Cold rolled steel 0.030" thick precisely die formed, 95% reflective matte white painted.

**Interior brackets** - Die formed cold rolled sheet steel 20 gauge thick.

**Center basket** - Extruded aluminum 0.07" nominal, matte white and lens made in clear PMMA precisely formed into optical micro-structures forms.

**Side lenses** - Frost impact acrylic lens 88% transmissive.

**Surface kit** - Extruded aluminum 0.07" nominal, matte white or aluminum powder coating. Custom finishes are also available.

#### WEIGHT

**Vega 1x4** - 17.18lbs.+6.94 lbs. - 7.8kg+3.15kg

#### CERTIFICATIONS

**ETL** - Rated for Indoor Dry/Damp locations. Conforms to UL Standard 1598 and certified to CAN/CSA Standard C22.2 No. 250.0.

#### WARRANTY

For all Chromawerx products, Lumenwerx provides a five-year limited warranty of electrical and mechanical performance of the luminaires, including the LED boards, drivers, and auxiliary electronics. Lumenwerx will repair or replace defective luminaires or components at our discretion, provided they have been installed and operated in accordance with our specifications. Other limitations apply, please refer to the full warranty on our website.

Wall controllers are covered by the manufacturer warranty.

# VEGA 1x4 LED

SURFACE

**LUMENWERX**  
WWW.LUMENWERX.COM

## CHROMAWERX QUADRO - RGBW

### QUADRO DMX SPECIFICATION

A qualified DMX integrator is required to assure proper installation and commissioning of the DMX network. **When placing the PO, please provide the contact information of your DMX integrator.**

Please answer the following questions to help us identify your DMX network requirements.

YES

Do you require a wall controller provided by Lumenwerx?

NO

DMX control system supplied by others. Lumenwerx will supply DMX-enabled fixtures with default DMX addressing. See following pages for technical DMX informations. ✓

DMX controller supplied by Lumenwerx

**How many zones do you have?**  
A zone consists of one or more luminaires behaving identically.

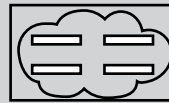

1 Zone



2 Zones

#### How to calculate the required number of drivers:

per 4' fixture  
**Driver**  
1x driver  
Less than 12.5W/ft, direct only

per 4' fixture  
**Driver Driver**  
2x driver  
Above 12.5W/ft or for all direct/indirect fixture

To Calculate # of drivers

1 Zone

2 to 3 Zones

4 or more Zones

Do you have more than 32 drivers in total?

NO

YES

Order a standard Lumenwerx wall controller type 1.

#### WALL CONTROLLER

**WC1W** - Single zone wall controller white  
**WC1B** - Single zone wall controller black

Add the control code at the end of your order code. Please provide a fixture layout or RCP (Reflected Ceiling Plan) showing the locations of the DMX fixtures, zones and the DMX wall controller. Refer to your DMX integrator for the installation. ✓

Subject to factory evaluation. Please contact our controls specialist at [controls@lumenwerx.com](mailto:controls@lumenwerx.com). Additional cost and equipment will be required. ✓

NO

YES

Order a standard Lumenwerx wall controller type 2.

#### WALL CONTROLLER

**WC2W** - 3 zone wall controller white  
**WC2B** - 3 zone wall controller black

Add the control code at the end of your order code. Please provide a fixture layout or RCP (Reflected Ceiling Plan) showing the locations of the DMX fixtures, zones and the DMX wall controller. Refer to your DMX integrator for the installation. ✓

Subject to factory evaluation. Please contact our controls specialist at [controls@lumenwerx.com](mailto:controls@lumenwerx.com). Additional cost and equipment will be required. ✓

Subject to factory evaluation and approval. Please contact our controls specialist at [controls@lumenwerx.com](mailto:controls@lumenwerx.com). Additional cost and equipment will be required. ✓

## CHROMAWERX QUADRO - RGBW

### GENERIC DMX NETWORK ARCHITECTURE

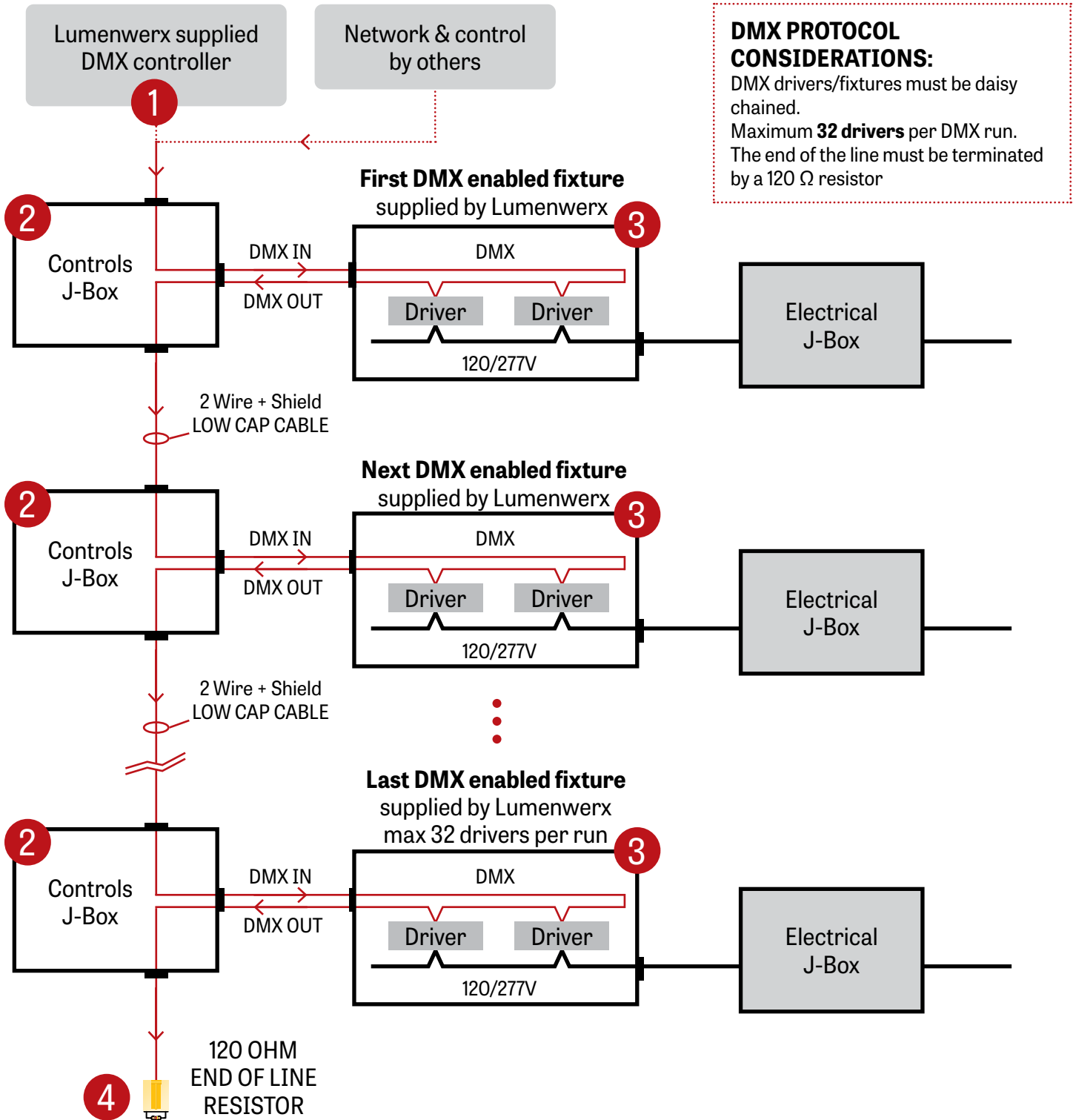

# VEGA 1x4 LED

SURFACE

**LUMENWERX**  
WWW.LUMENWERX.COM

## CHROMAWERX QUADRO - RGBW

### 1 LUMENWERX SUPPLIED DMX CONTROLLER

To the first fixture

2 Wire +  
Shield Low Cap Cable

WALL BOX SUPPLIED BY OTHERS

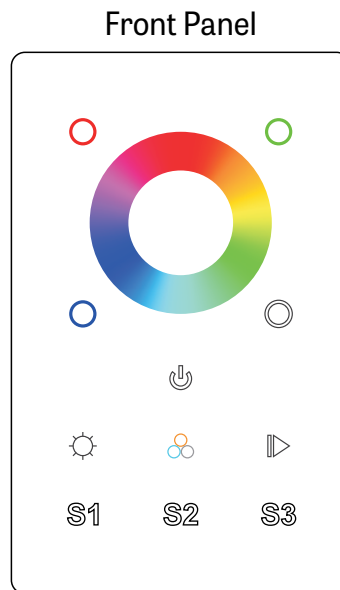
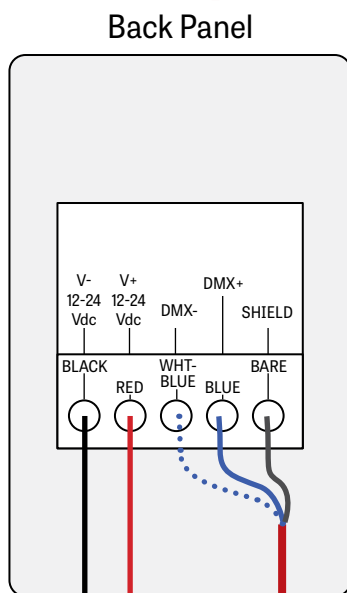

I.E.: Cerco Cable 7539-10  
Belden 9841  
Belden 8241

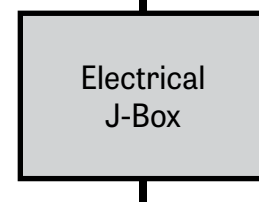
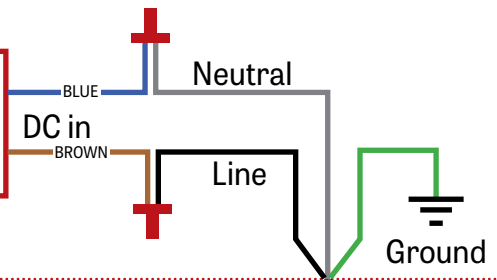
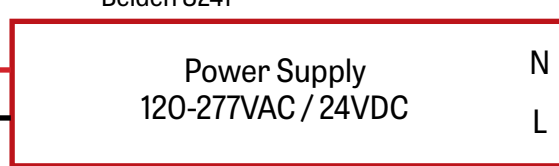

## CHROMAWERX QUADRO - RGBW

### 2 J-BOX DMX DAISY CHAIN DETAIL

#### Low capacitance DMX Cable from Previous Fixture

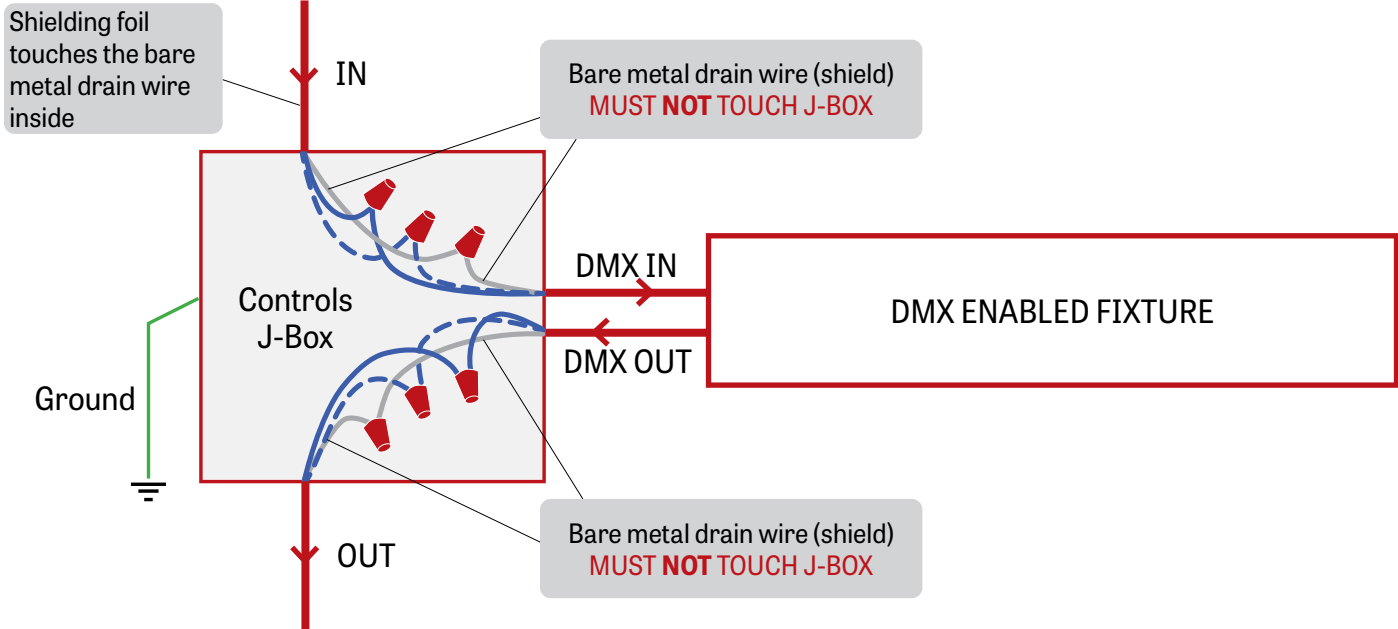

#### Low capacitance DMX cable to next fixture

### 3 DMX CONNECTION RECESSED & SURFACE

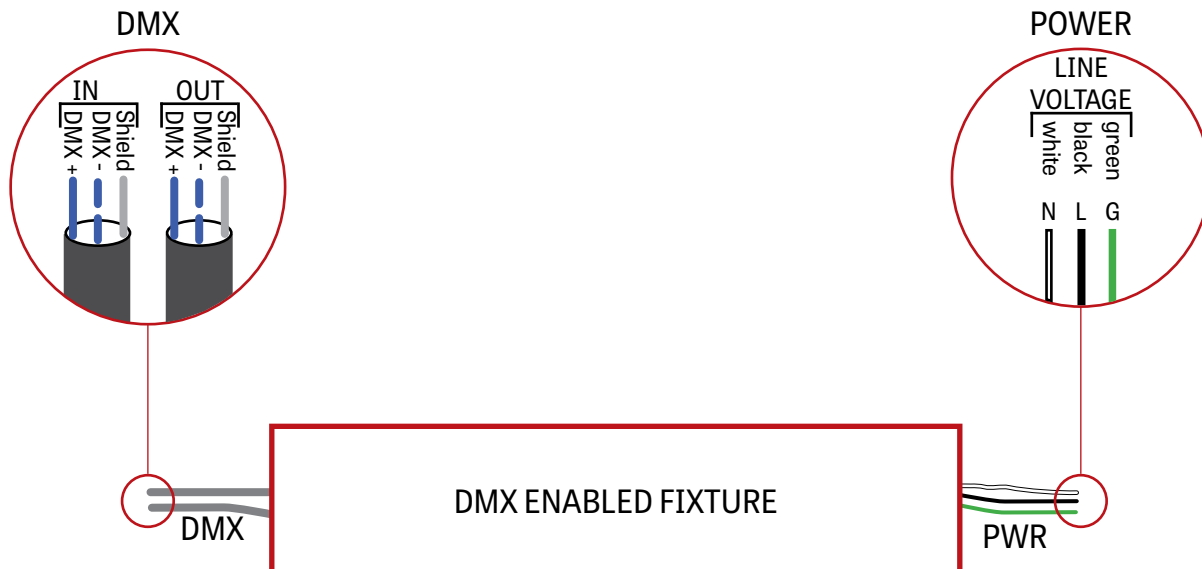

CHROMAWERX QUADRO - RGBW

4 DMX LAST FIXTURE DETAIL

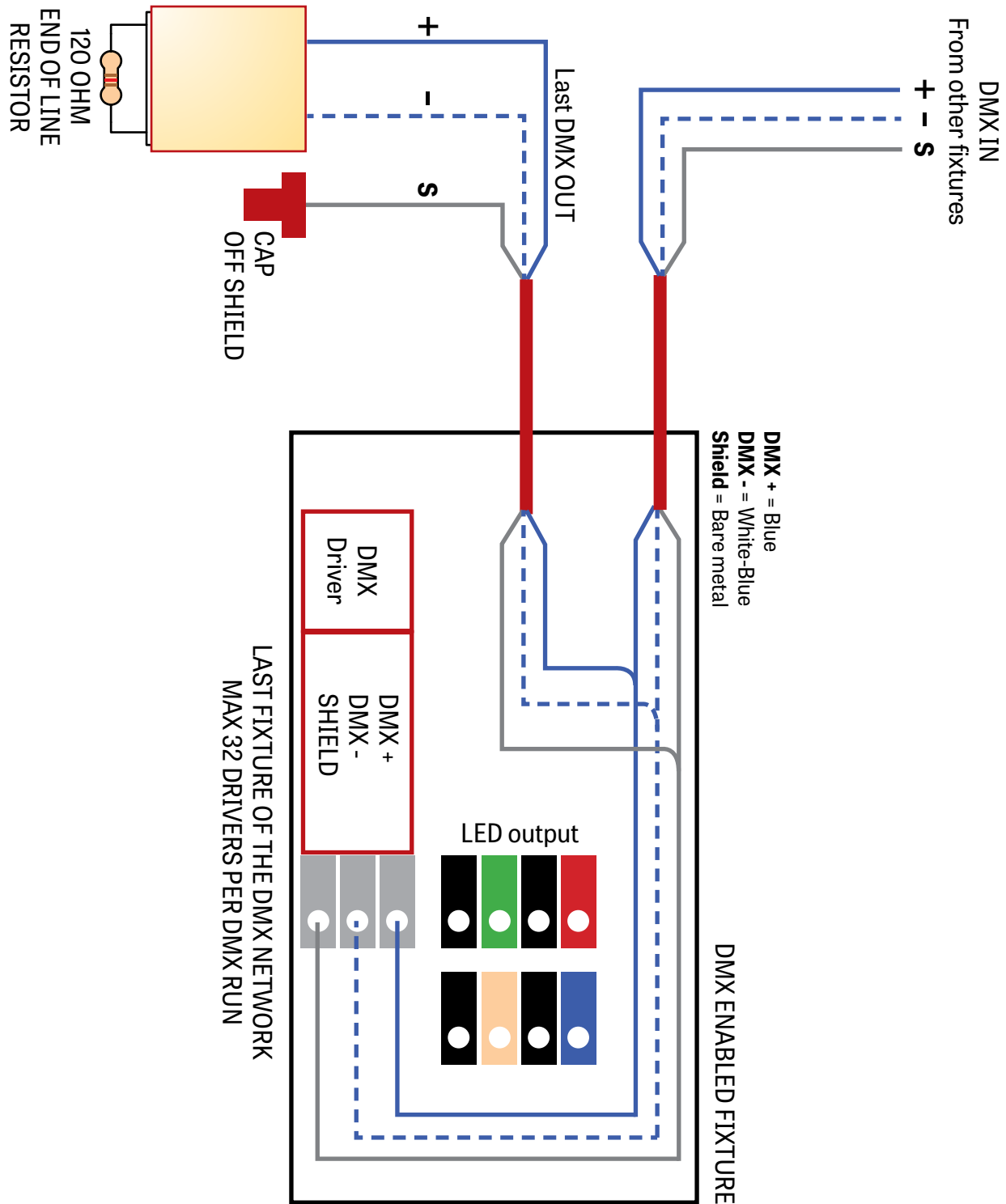



## CHROMAWERX QUADRO - RGBW

### DMX WALL CONTROLLER

#### WC1

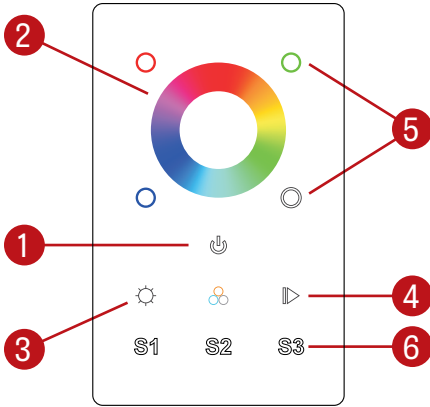

- (1) Power: Use this button to turn ON or OFF the RGBW fixture.
- (2) Color Wheel: The wheel is used to rapidly select a color (RGB colors only).
- (3) Brightness (RGB): Hold down this button to either increase or decrease the brightness of the current RGB selection. White will not be affected by the RGB brightness button.
- (4) Color Cycle: This button will start an animation, rotating between Reds Greens and Blues, the arrows allow the user to speed up or slow down the animation.
- (5) Individual Colors: By pressing and holding a color it will be possible to brighten or dim it. Quickly pressing a color will turn it OFF or turn it ON to its previous dim level.  
White: In order to activate or deactivate and dim the White channel, the White button needs to be used.
- (6) Scenes: By holding down one of the scenes button, the current color selection is saved. It can be later accessed by quickly pressing on one of the Scene buttons.

#### WC2

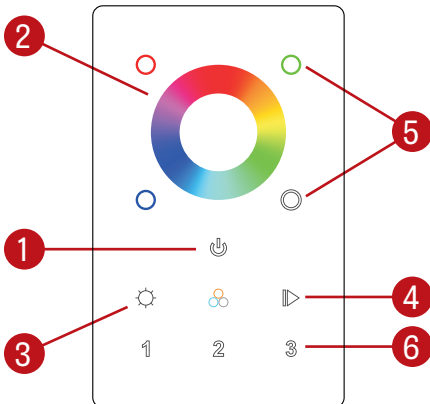

- (1) Power: Use this button to turn ON or OFF the RGBW fixture.
- (2) Color Wheel: The wheel is used to rapidly select a color (RGB colors only).
- (3) Brightness: Hold down this button to either increase or decrease the brightness of the current RGB selection. White will not be affected by the RGB brightness button.
- (4) Color Cycle: This button will start an animation, rotating between Reds Greens and Blues, the arrows allow the user to speed up or slow down the animation.
- (5) Individual Colors: By pressing a color it will be possible to brighten or dim that specific color.  
White: In order to activate or deactivate and dim the White channel, the White button needs to be used.
- (6) Zone: By holding down one of the zone buttons, a zone can be selected and controlled.

#### Default DMX Addresses:

- 1 Red
- 2 Green
- 3 Blue
- 4 White