

VEGA 1x4 LED

RECESSED



LUMENWERX
WWW.LUMENWERX.COM

CHROMAWERX TUNABLE WHITE AND DIM TO WARM

IMPORTANT: a qualified DMX integration consultant is required to ensure proper installation and function of any DMX network

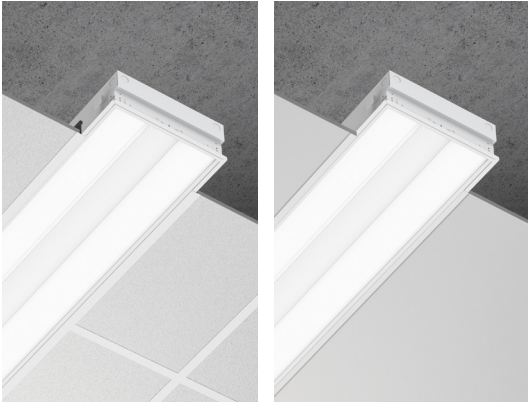

Grid ceiling

Drywall ceiling

DESCRIPTION

Vega is an efficient architectural LED troffer with a distinctive luminous shielding that features a median textured optic. Using advanced LED engines, Vega provides highly efficient illumination and offers comprehensive ceiling, electrical, and controls options in 2x2, 1x4, and 2x4 sizes. Vega is an ideal vehicle for ChromaWerx white tuning in education, office, and healthcare applications where modular luminaires are used. See separate spec sheets for other available mountings.

PROJECT: _____

APPROVED BY: _____

SIGNATURE: _____

ORDER GUIDE

IC RATED

VEGR	14	MTO	HLO	LED			
LUMINAIRE ID	SIZE	CENTER OPTICS	SIDE OPTICS	LIGHT SOURCE	CRI	LUMEN PACKAGES	CHROMAWERX
VEGR - vega recessed	14 - 1'x4'	MTO - Median Textured Optic	HLO - High-Efficiency Lambertian Optic	LED - high performance LED	80 - 80CRI 90 - 90CRI	2300 - min. low output 2300lm 3200 - medium output 3200lm 4200 - max. high output 4200lm #### - other required lm	DUO - tunable white 2 channel control 27k to 65k SOLA - dim to warm single channel control 22k to 35k

		1				
VOLTAGE	DRIVER	ELECTRICAL	MOUNTING	FINISH	OPTIONS	
120 - 120V 277 - 277V	DMX - to specify see pages 5 to 10 DA - Dali (duo only) local on-site commissioning is required O-10 - Single 0-10V input (Sola) or dual 0-10V input for CCT/Intensity (Duo) PSQO - Lutron T-Series 1% Tunable White	1 - 1 circuit	TG9 - tegular 9/16" TG15 - tegular 15/16" TB9 - t-bar 9/16" TB15 - t-bar 15/16" ST - screw slot t-bar DF - drywall kit	W - matte white CF# - custom finish specify RAL#	FU - fuse FWC - flexible whip cable (6' std) CP - Chicago Plenum CU - custom	

DMX WALL CONTROLS

To specify see pages 5 to 10

See page 2 for ordering code detailed information

CROSS SECTION

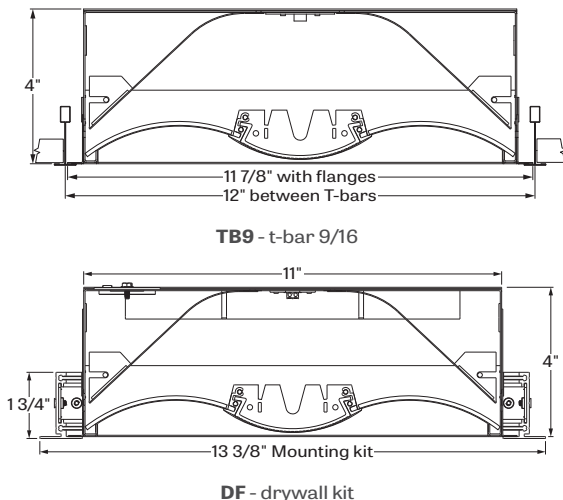

ANSI C78.377-2015

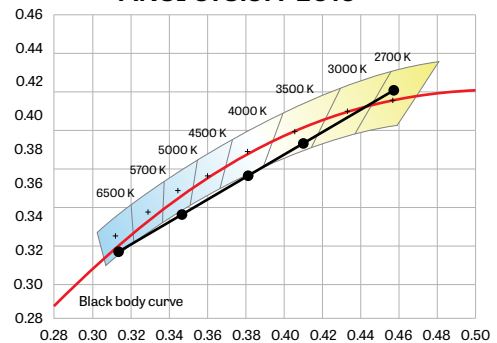

CHROMAWERX TUNABLE WHITE AND DIM TO WARM

OPTICS

CENTER LENS - MEDIAN TEXTURED OPTIC (MTO) - Median Textured Optic (MTO) shielding consisting of ribbed diffusing center element.

SIDE LENS - HIGH EFFICIENCY LAMBERTIAN OPTIC (HLO) - Curved sides of diffusing 0.075" thick acrylic with 90% transmission and good source obscuration. Luminaire brightness is controlled by the flux-to-shielding area ratio in addition to offering a gentle gradient from center to edge.

LIGHT SOURCE - LED

LED output	Color Temp	Watts	Nominal Delivered Lumens	Efficacy LPW
low output	4000K	23	2300	99
medium output	4000K	33	3200	98
high output	4000K	43	4200	98

Lumen Adjustment Factors

2700K	0.917
3000K	0.959
3500K	0.988
4000K	1.000
6500K	1.053

Custom array of alternating color temperature mid-flux LED's are mounted directly to the housing for optimal thermal performance. For the Duo products, a color temperature range from 2700K-6500K is achievable with color points on or below the black body curve. For the Sola products, a color temperature range from 2200K-3500K is controlled synchronously with intensity. Color consistency between fixtures is maintained to within 3SDCM. LEDs are operated at reduced drive current to optimize efficacy and lumen maintenance. All LED's have been tested in accordance with IESNA LM-80-08 and the results have shown L80 lumen maintenance greater than 60,000 hours. Absolute product photometry is measured and presented in accordance with IESNA LM-79, unless otherwise indicated.

CHROMAWERX - TUNABLE WHITE

ANSI C78.377-2015

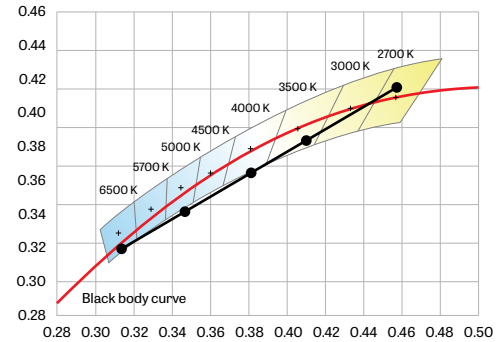

ChromaWerx Sola is single-channel control that dims output while warming the color temperature in a pre-determined relationship. A simple digital or analog control sends a common signal to dual output digital drivers, which are programmed to adjust a specially populated LED array to emulate the effect of dimming a filament source. Dimming range is programmable but the default option runs from 3500K at 100% of full power to 2200K at 5% of full power. CRI is maintained above 80 throughout the dimming range.

ChromaWerx Duo is two-channel control. It uses an analog (0-10V) protocol for separate control of luminaire CCT and intensity or a digital (DMX, DALI) protocol for synchronous control of both warm and cool LED arrays to enable the user to set color temperature and light output. Commonly called "tunable white", ChromaWerx two-channel control provides the range of warm (2700K) to cool (6500K) color that can be useful for helping to entrain circadian rhythms, stimulate alertness for improved educational and work productivity, and compensate for jet lag, among other applications. The ChromaWerx drivers are programmed to limit maximum light output and power usage across all color temperatures. CRI is maintained above 80.

VEGA 1x4 LED

RECESSED

LUMENWERX
WWW.LUMENWERX.COM

CHROMAWERX TUNABLE WHITE AND DIM TO WARM

ELECTRICAL

DMX (Duo only)

Factory-set, adjustable output current, multi-channel LED driver with universal (120-277VAC) input. Using DMX wall controls (optionally supplied by LumenWerx) or an existing DMX control system, two channels of LEDs (warm-white & cool-white) are independently adjustable. Each DMX driver has multiple output channels that can be independently addressed at the factory or on-site using built-in RDM (Remote Device Management) functionality. Dimming range from 100%-0%. At maximum driver load, efficiency<89%, PF>0.9, THD<20%.

Dali (Duo Only)

Factory-set, adjustable output current LED driver with universal (120-277VAC) input. Using an existing DALI control system (supplied by others), one control channel adjusts the fixture color temperature, and the other control channel adjusts fixture brightness. Dimming range from 100%-0%. At maximum driver load, efficiency<86%, PF>0.9, THD<20%.

0-10V (Solo)

Factory-set, adjustable output current LED driver with universal (120-277VAC) input. Using a single 0-10V control signal, the light output warms in color temperature as it dims down to 1% and 2200K. At maximum driver load, efficiency<86%, PF>0.9, THD<20%.

0-10V (Duo)

Factory-set adjustable output current LED driver with universal (120-277VAC) input. Controlled via two individual 0-10V signals, one for setting light output down to a minimum of 1% and the other for adjusting the CCT (default range of 2700K-6500K). Rated life of 50,000 hours at 70°C maximum driver case temperature and 100% load conditions. Typical efficiency of 86%, PF>0.9, THD<20% at 100% load conditions.

MOUNTING OPTIONS

Recess mount into exposed or concealed T-Bar or Tegular grid ceiling

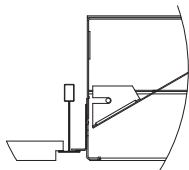

TG9 - tegular 9/16"

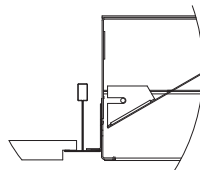

TG15 - tegular 15/16"

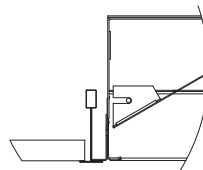

TB9 - t-bar 9/16"

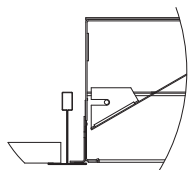

TB15 - t-bar 15/16"

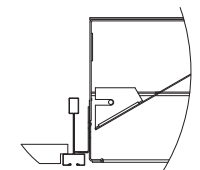

ST - screw slot t-bar

A separate kit for mounting fixtures into drywall ceilings

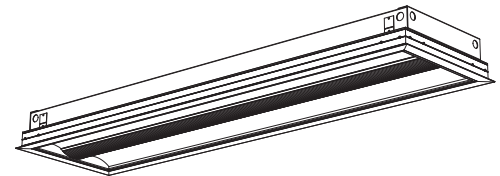
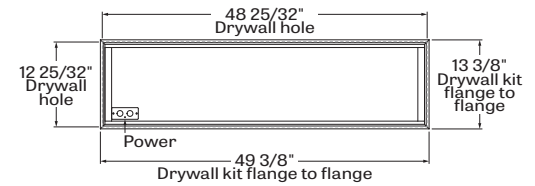

DF - drywall kit

FINISH

Interior reflectors - 95% reflective, matte white powder coating

Exterior - matte white powder coating.

Custom finish is also available.

CONSTRUCTION

Housing - Die formed cold rolled sheet steel 20 gauge thick, matte white powder coating.

Reflectors - Cold rolled steel 0.030" thick precisely die formed, 95% reflective matte white painted.

Interior brackets - Die formed cold rolled sheet steel 20 gauge thick.

Center basket - Extruded Aluminum 0.07" nominal, matte white and lens made in clear PMMA precisely formed into optical micro-structures forms.

Side lenses - Frost impact acrylic lens 88% transmissive.

Drywall kit - Extruded Aluminum 0.07" nominal, matte white powder coating.

WEIGHT

Vega 1x4 - 17.18lbs.+3.08 lbs. (drywall kit) - 7.8kg+1.4kg (drywall kit)

CERTIFICATIONS

ETL - Rated for Indoor Dry/Damp locations.

Conforms to UL Standard 1598 and certified to CAN/CSA Standard C22.2 No. 250.0.

Chicago plenum - City of Chicago Approved (CCEA)

IC rated - suitable for direct contact with insulation.

VEGA 1x4 LED

RECESSED



CHROMAWERX TUNABLE WHITE AND DIM TO WARM

WARRANTY

For all ChromaWerx products, LumenWerx provides a three-year limited warranty of electrical and mechanical performance of the luminaires, including the LED boards, drivers, and auxiliary electronics. LumenWerx will repair or replace defective luminaires or components at our discretion, provided they have been installed and operated in accordance with our specifications. Other limitations apply, please refer to the full warranty on our website.

Wall controllers are covered by the manufacturer warranty.



VEGA 1x4 LED

RECESSED

CHROMAWERX TUNABLE WHITE

DUO DMX SPECIFICATION

A qualified DMX integrator is required to assure proper installation and commissioning of the DMX network. **When placing the PO, please provide the contact information of your DMX integrator.**

Please answer the following questions to help us identify your DMX network requirements.

YES

Do you require a wall controller provided by Lumenwerx?

NO

DMX control system supplied by others. Lumenwerx will supply DMX-enabled fixtures with default DMX addressing. See following pages for technical DMX informations. ✓

DMX controller supplied by Lumenwerx

How many zones do you have?
A zone consists of one or more luminaires behaving identically.



1 Zone



2 Zones

How to calculate the required number of drivers:

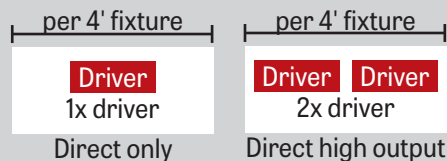

To Calculate # of drivers

1 - 4 Zones

5 or more Zones

Do you have more than 32 drivers in total?

NO

YES

Order a standard Lumenwerx wall controller.

WALL CONTROLLER

WCW - wall controller white
WCB - wall controller black

Add the control code at the end of your order code.

Please provide a fixture layout or RCP (Reflected Ceiling Plan) showing the locations of the DMX fixtures, zones and the DMX wall controller.

Refer to your DMX integrator for the installation. ✓

Subject to factory evaluation. Please contact our controls specialist at controls@lumenwerx.com. Additional cost and equipment will be required. ✓

Subject to factory evaluation and approval. Please contact our controls specialist at controls@lumenwerx.com. Additional cost and equipment will be required. ✓

VEGA 1x4 LED

RECESSED

CHROMAWERX TUNABLE WHITE

GENERIC DMX NETWORK ARCHITECTURE

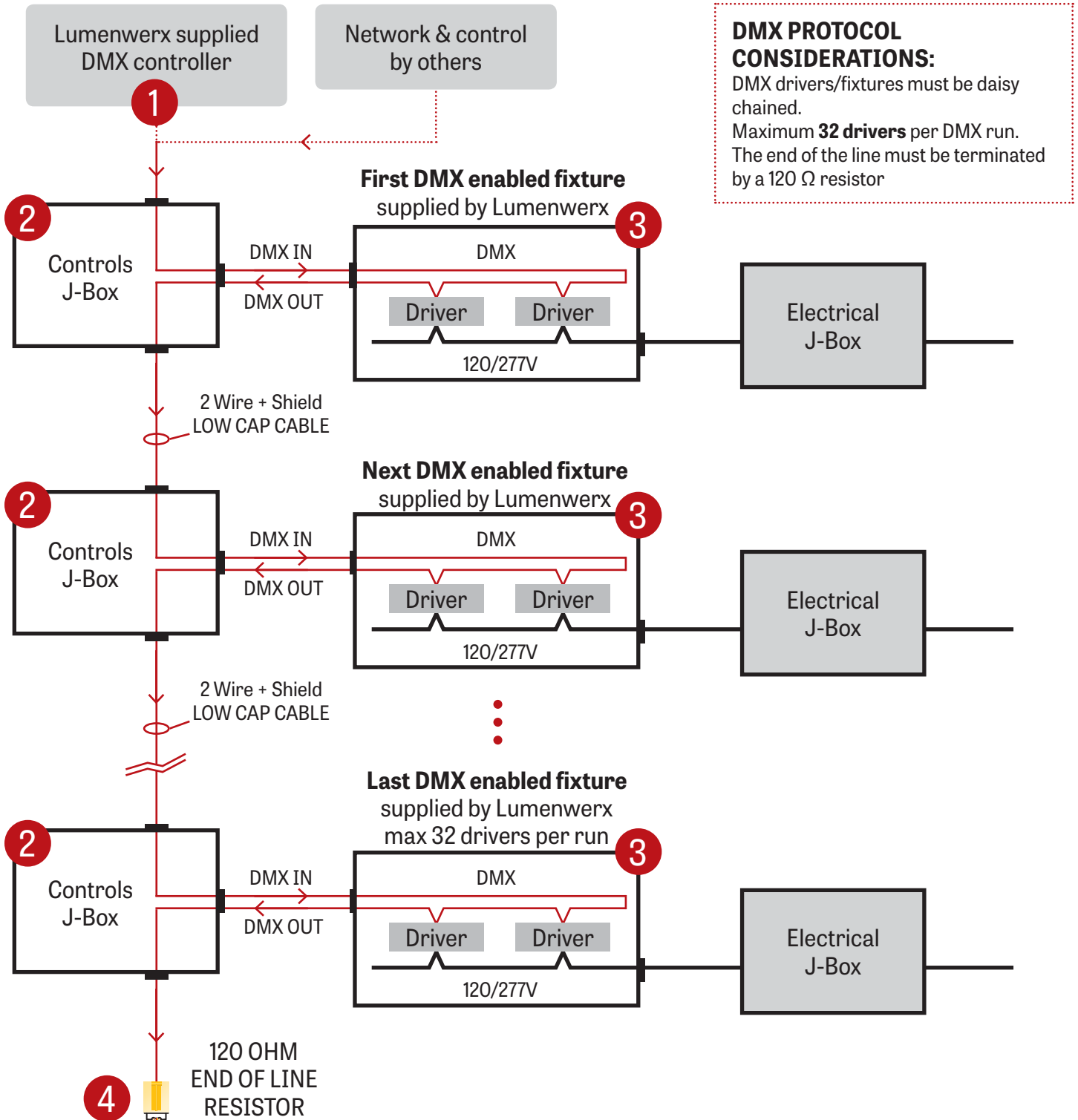

VEGA 1x4 LED

RECESSED

CHROMAWERX TUNABLE WHITE

1 LUMENWERX SUPPLIED DMX CONTROLLER

To the first fixture

WALL BOX SUPPLIED BY OTHERS

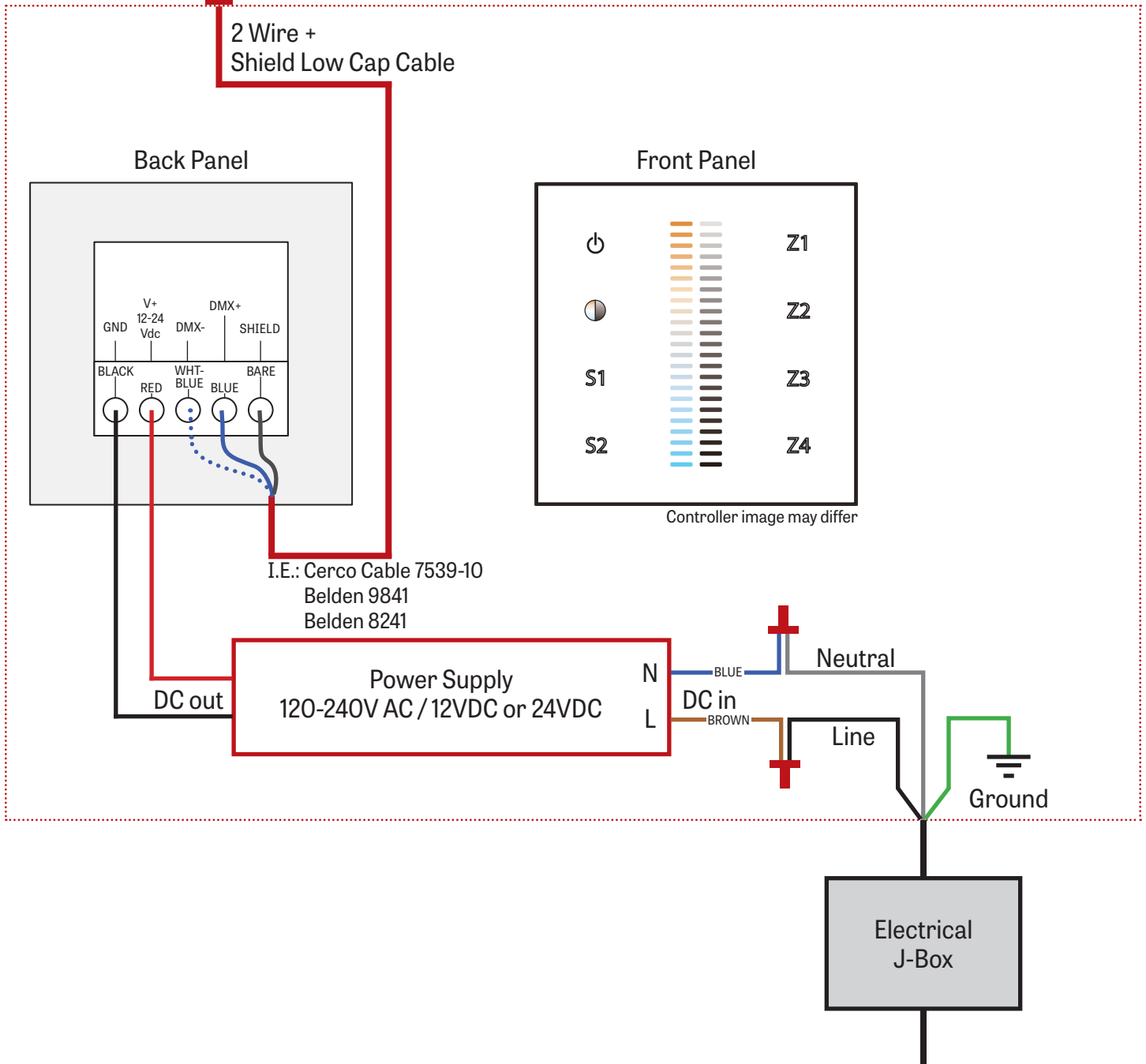

CHROMAWERX TUNABLE WHITE

2 J-BOX DMX DAISY CHAIN DETAIL

Low capacitance DMX Cable from Previous Fixture

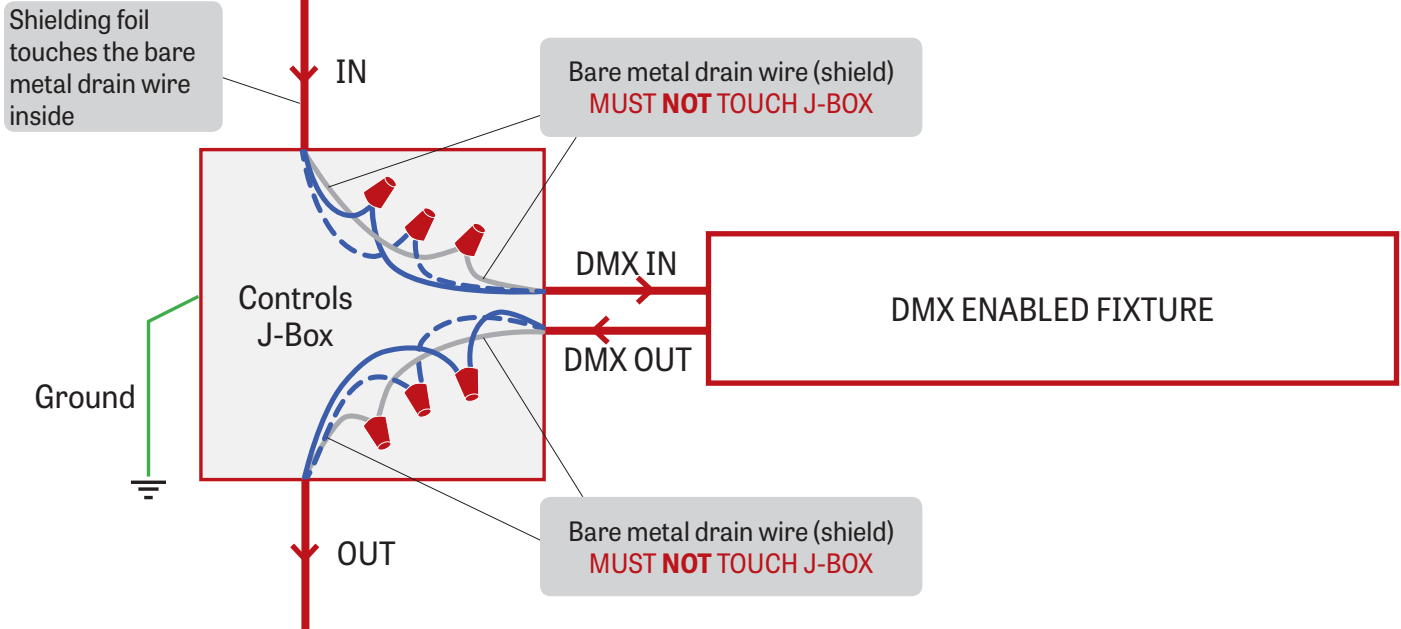

Low capacitance DMX cable to next fixture

3 DMX CONNECTION RECESSED & SURFACE

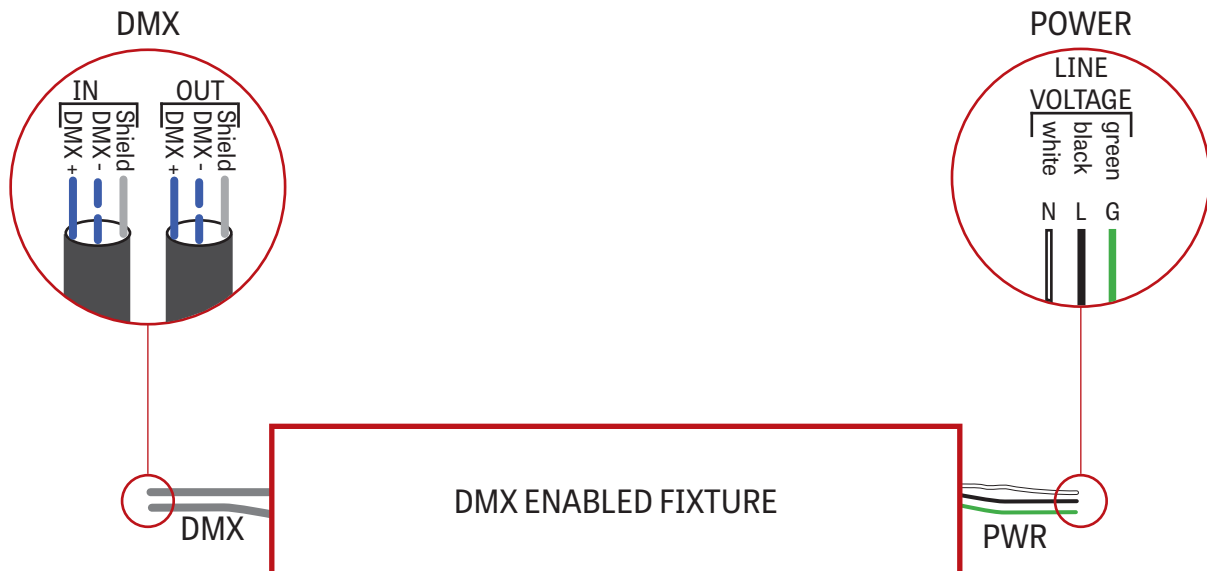

VEGA 1x4 LED

RECESSED

LUMENWERX
WWW.LUMENWERX.COM

CHROMAWERX TUNABLE WHITE

4 DMX LAST FIXTURE DETAIL

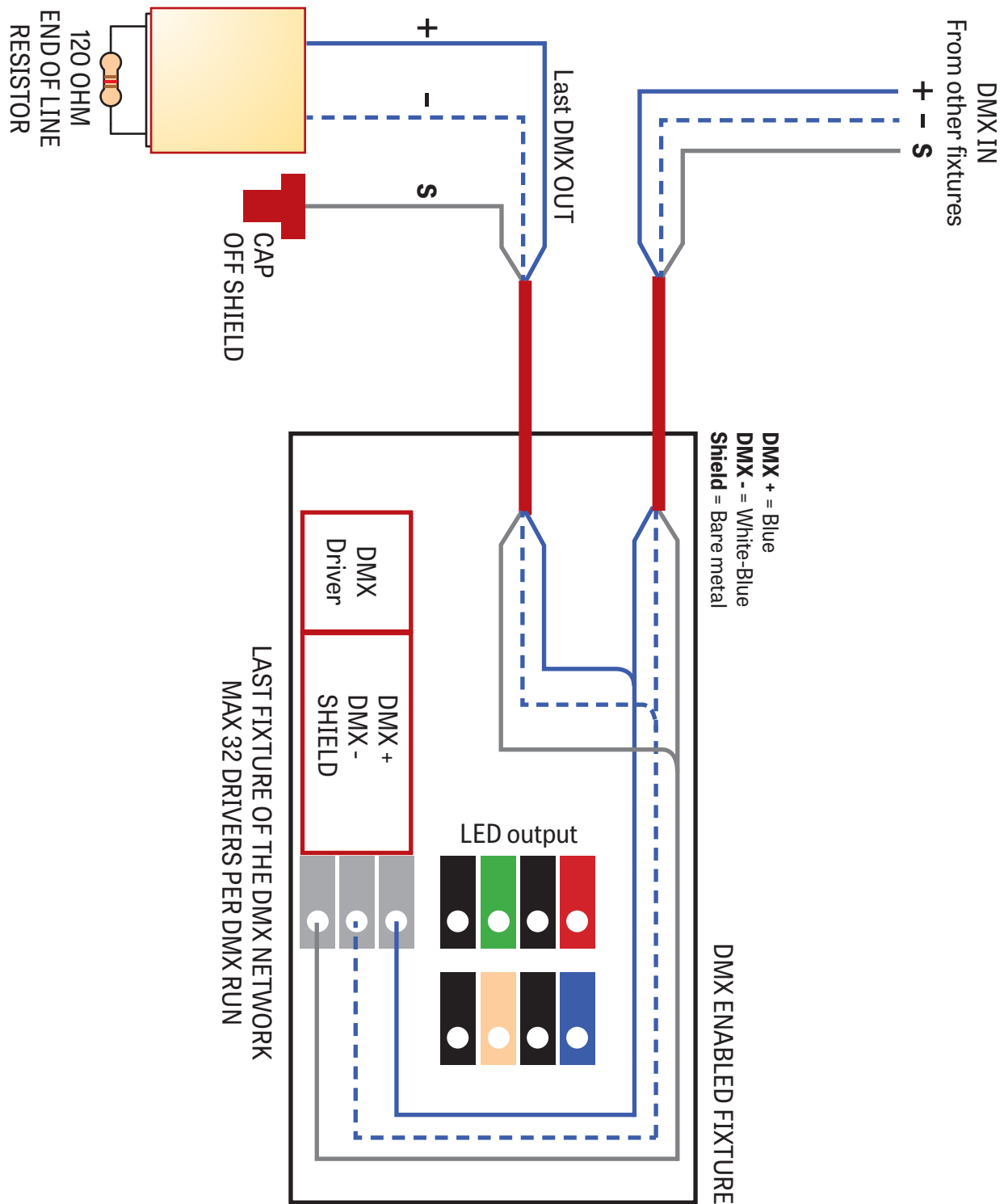

VEGA 1x4 LED

RECESSED

CHROMAWERX TUNABLE WHITE

DMX WALL CONTROLLER

DUO 1-4 ZONE

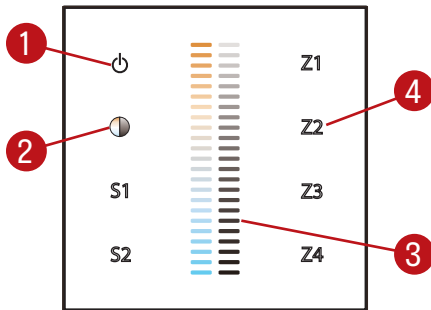

- (1) Power: Use this button to turn ON or OFF the fixture
- (2) Brightness/CCT: Use the color/brightness toggle button to chose between color/brightness. when Blue: brightness is selected, when Yellow: color is selected.
- (3) Slider: Depending on the mode chosen in 2, the slider will allow the user to set desired color or brightness.
- (4) Zone select: Up to 4 zones can be selected either independently or together. Once selected the commands will be sent to the zone identified by a Blue LED.

Default DMX Addresses:

- 1 Warm
- 2 Cool

VEGA 1x4 LED

RECESSED

CHROMAWERX TUNABLE WHITE AND DIM TO WARM

2300 LUMEN AT 80CRI - LOW OUTPUT

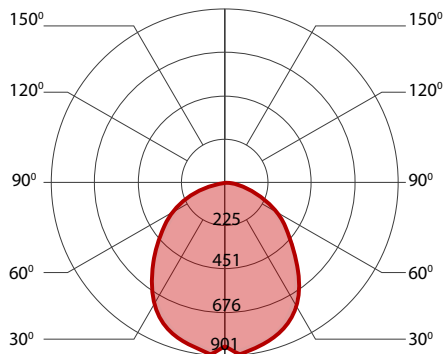

PERFORMANCE

LED output	Color Temp	Watts	Nominal Delivered Lumens	Efficacy LPW
low output	2700K	25.5	2300	91
low output	3000K	25	2300	93
low output	3500K	24	2300	96
low output	4000K	23	2300	99
low output	6500K	22.5	2300	103

3200 LUMEN AT 80CRI - MEDIUM OUTPUT

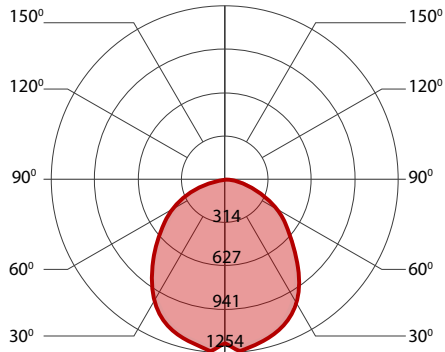

PERFORMANCE

LED output	Color Temp	Watts	Nominal Delivered Lumens	Efficacy LPW
medium output	2700K	35.5	3200	90
medium output	3000K	35	3200	92
medium output	3500K	34	3200	95
medium output	4000K	33	3200	98
medium output	6500K	31.5	3200	102

4200 LUMEN AT 80CRI - HIGH OUTPUT

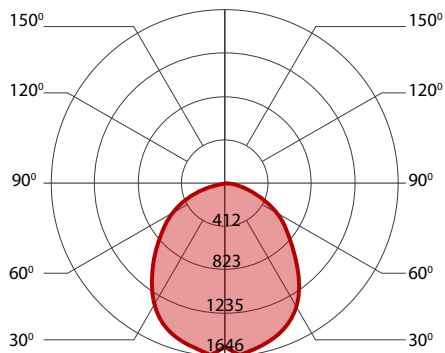

PERFORMANCE

LED output	Color Temp	Watts	Nominal Delivered Lumens	Efficacy LPW
high output	2700K	46.5	4200	90
high output	3000K	46	4200	92
high output	3500K	44	4200	95
high output	4000K	43	4200	98
high output	6500K	41	4200	102