

VEGA 1x4

RECESSED

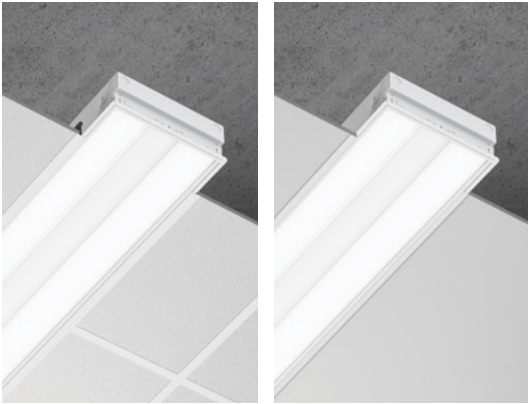

Grid ceiling

Drywall ceiling

DESCRIPTION

Vega is an efficient architectural troffer with a distinctive luminous shielding that features a median textured optic. Vega provides highly efficient illumination and offers comprehensive ceiling, electrical, and controls options in 2x2, 1x4, and 2x4 sizes. See separate spec sheets for LED and other available mountings.

PROJECT: _____

APPROVED BY: _____

SIGNATURE: _____

| TYPE | QTY |
|------|-----|
| | |

ORDER GUIDE

IC RATED

| VEGR | 14 | MTO | HLO | | | | |
|----------------------|------------|-----------------------------|--|--|---------------------------|---|--|
| LUMINAIRE ID | SIZE | CENTER OPTICS | SIDE OPTICS | LIGHT SOURCE | NUMBER OF LAMPS | VOLTAGE | BALLAST |
| VEGR - vega recessed | 14 - 1'x4' | MTO - Median Textured Optic | HLO - High-Efficiency Lambertian Optic | T5 - T5 lamp T5HO - T5HO lamp T8 - T8 lamp | 1 - 1 lamp 2 - 2 lamps | 120 - 120V 277 - 277V UNV - 120V-277V 347 - 347V (not available with Lutron) | RS - rapid start D - dimming 0-10V ST - step dimming DA - dali LHL - Lutron Hi-Lume 3D LEH - Lutron EcoSystem H |

| ELECTRICAL | MOUNTING | FINISH | CONTROLS | OPTIONS |
|--|---|---|--|---|
| 1 - 1 circuit 2 - 2 circuits EM - emergency light circuit NL - night light circuit +EB - emergency battery pack +GTD### - generator transfer device, 120V or 277V | TG9 - tegular 9/16" TG15 - tegular 15/16" TB9 - t-bar 9/16" TB15 - t-bar 15/16" ST - screw slot t-bar DF - drywall kit | W - matte white CF# - custom finish specify RAL# | <u>INDIVIDUAL CONTROLS</u> OMS - Onboard Occupancy ODS - Onboard Daylight OCS - Onboard Occupancy & Daylight <u>GROUPED CONTROLS</u> LSC - Local system NSC - Network system | FU - fuse FWC - flexible whip cable (6' std) CP - Chicago Plenum CU - custom |

See page 4 for ordering code detailed information

CROSS SECTION

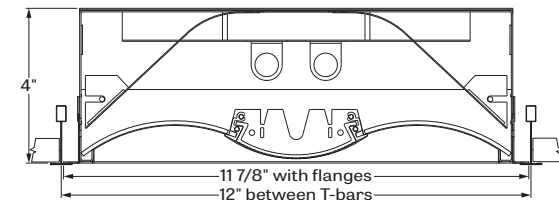

TB9 - t-bar 9/16

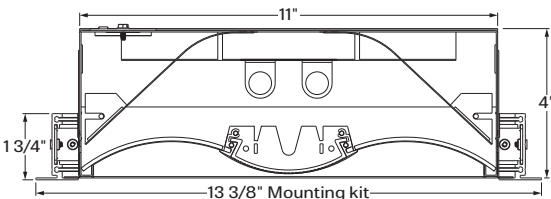

DF - drywall kit

OPTICS



HLO Side optics - High-Efficiency Lambertian
MTO Center optics - Median Textured Optic

VEGA 1x4

RECESSED

VEGA - 1 LAMP

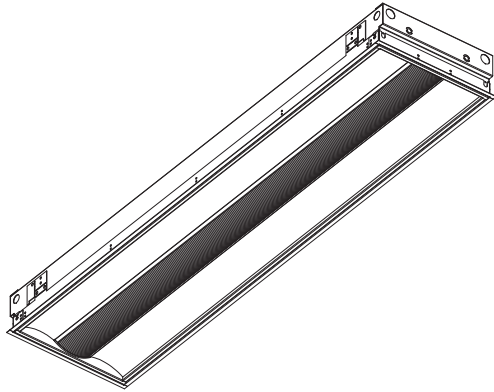

VEGA - 2 LAMPS

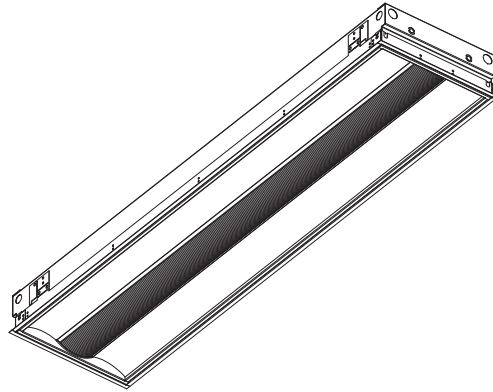

VEGA - TG9 - tegular 9/16"

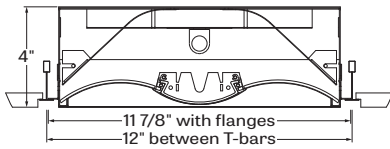

VEGA - TG9 - tegular 9/16"

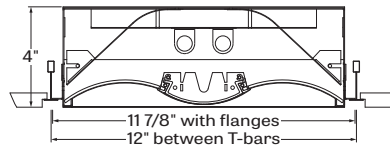

VEGA - TG15 - tegular 15/16"

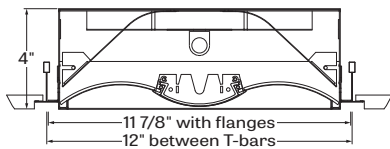

VEGA - TG15 - tegular 15/16"

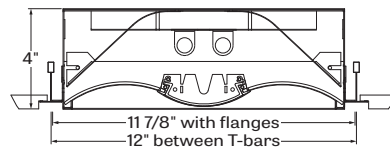

VEGA - TB9 - t-bar 9/16"

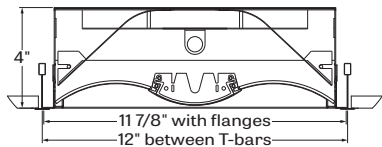

VEGA - TB9 - t-bar 9/16"

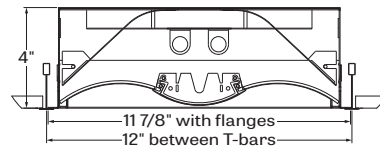

VEGA - TB15 - t-bar 15/16"

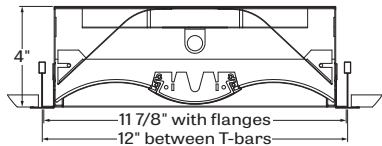

VEGA - TB15 - t-bar 15/16"

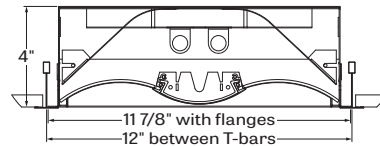

VEGA - ST - screw slot t-bar

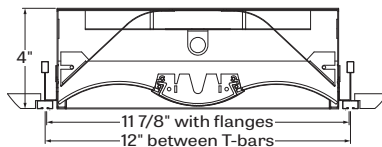

VEGA - ST - screw slot t-bar

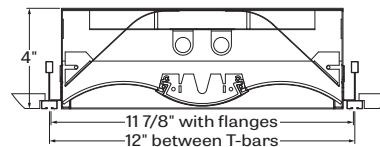

VEGA - DW - drywall kit

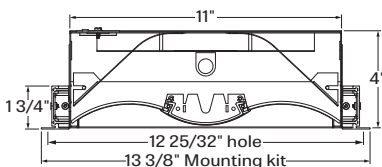

VEGA - DW - drywall kit

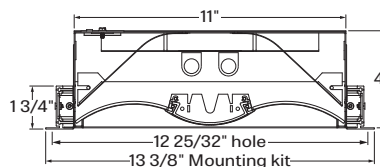

ELECTRICAL CIRCUITS

RAPID START - 1 Circuit

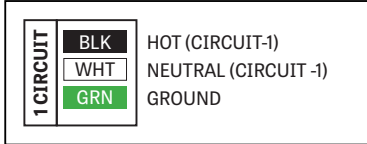

RAPID START - 1 Circuit + Emergency Battery

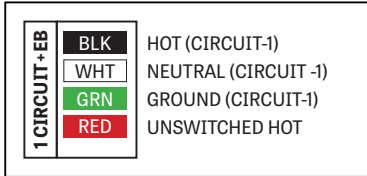

RAPID START - 1 Circuit + Emergency Circuit

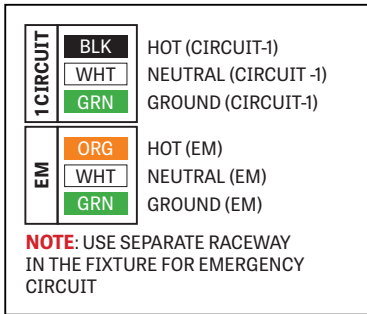

RAPID START - 2 Circuits

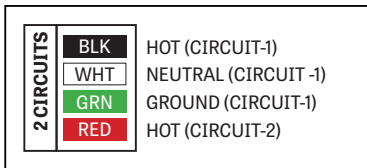

DIMMING 0-10V - 1 Circuit

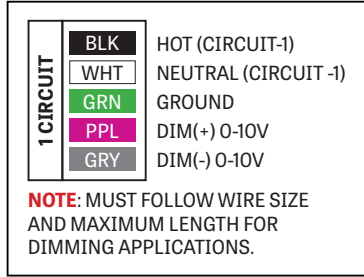

DIMMING 0-10V - 1 Circuit + Emergency Battery

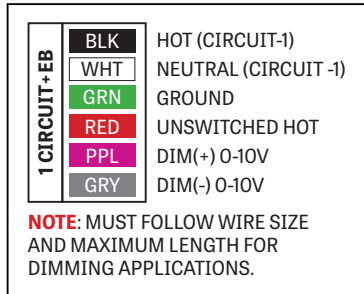

LUTRON Hi-Lume 3D - 1 Circuit

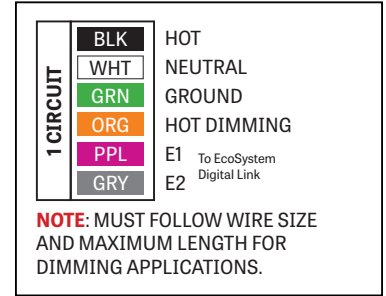

LUTRON Hi-Lume 3D - 1 Circuit+ Emergency Battery

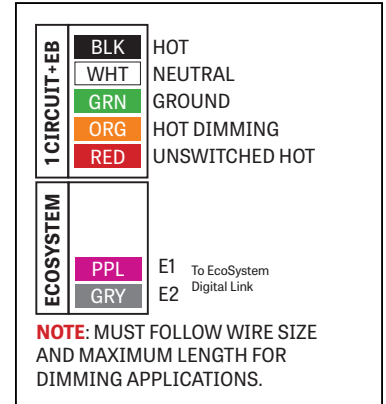

LUTRON ECOSYSTEM H - 1 Circuit

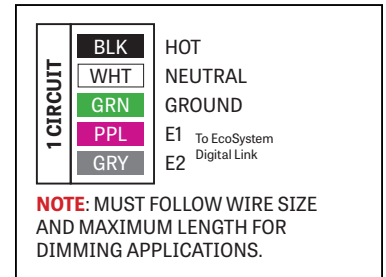

LUTRON ECOSYSTEM H - 1 Circuit + Emergency Battery

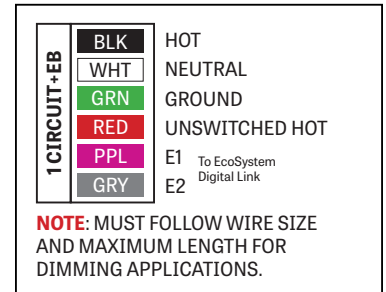

VEGA 1x4

RECESSED

OPTICS

CENTER LENS - MEDIAN TEXTURED OPTIC (MTO) - Median Textured Optic (MTO) shielding consisting of ribbed diffusing center element.

SIDE LENS - HIGH EFFICIENCY LAMBERTIAN OPTIC (HLO) - Curved sides of diffusing 0.075" thick acrylic with 90% transmission and good source obscuration. Luminaire brightness is controlled by the flux-to-shielding area ratio in addition to offering a gentle gradient from center to edge.

ELECTRICAL

Universal input voltages with multiple control schemes offered. Consult factory for availability.

EMERGENCY

Factory installed long life high temperature recyclable Ni-Cad battery pack with test switch and charge indicator, minimum of 90 minutes operation. Recharge time of 24 hours.

MOUNTING OPTIONS

Recess mount into exposed or concealed T-Bar or Tegular grid ceiling

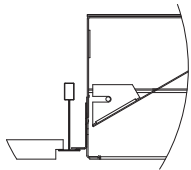

TG9 - tegular 9/16"

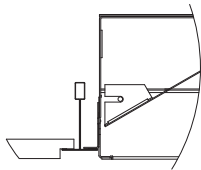

TG15 - tegular 15/16"

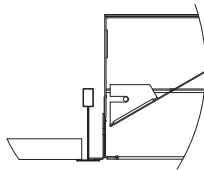

TB9 - t-bar 9/16"

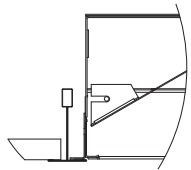

TB15 - t-bar 15/16"

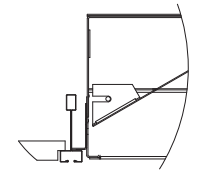

ST - screw slot t-bar

A separate kit for mounting fixtures into drywall ceilings

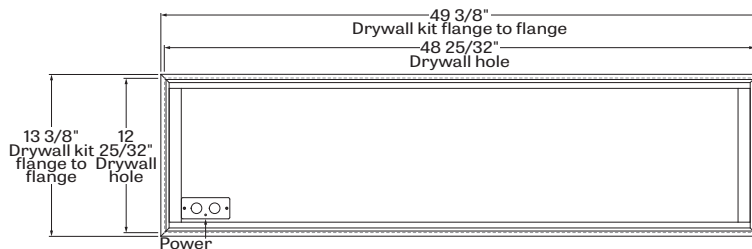

DF - drywall kit

FINISH

Interior reflectors - 95% reflective, matte white powder coating

Exterior - matte white powder coating.
Custom finish is also available.

CONTROLS

LumenWerx offers several options for integrating occupancy and daylight controls. Whether a sensors control its own fixture or is part of a group of fixtures, lights can be automatically controlled according to different energy saving strategies. With **individual Controls**, an on-board sensor controls the fixture in which it is installed. Depending on the length, more than one sensor may be necessary and may control the entire fixture, or just a section.

With **Grouped Controls**, on-board or remote sensor are part of a either a local or network sensor infrastructure. It's possible to scale the controls, from a switch to a fixture setup, to a room or a whole building Occupancy and or daylight harvesting.

INDIVIDUAL CONTROLS

Individual controls are integrated into the fixture and are therefore easy to use and allow for a cleaner looking space as no ceiling or wall-mounted sensors are required. Individual controls can be one of three types (**OMS**) Occupancy, (**ODS**) Daylight Harvesting (Photocell), or (**OCS**) combined occupancy and daylight harvesting. These controls will be installed with factory settings, but most offer field adjustability with regular tools or manufacturer supplied configuration tools.

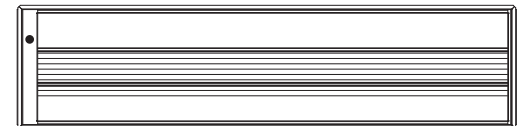

Location of an Onboard control

GROUPED CONTROLS

Local systems permit added flexibility and interconnectivity. Each fixture can now become part of a group of fixtures and be controlled by On-Board or remote sensors as well as wireless switches or controllers. With this architecture, it is now possible to have fewer fixtures with On-Board sensor which control all of the fixtures of the lighting zone. In order to have grouped controls programmed in factory, it is required that a floor layout with requested grouping and functionality be supplied. Field commissioning is also possible but must be requested and discussed before final Purchase Order is placed.

Network Controls, Lumenwerx fixtures are compatible with most popular BMS integration protocols such as DALI, DMX, EnOcean, BACnet, Enlighted and Lutron Ecosystem just to name a few. Field commissioning is usually required and details must be discussed before final Purchase Order is placed.

Please contact our controls department at controls@lumenwerx.com for further assistance.

CONSTRUCTION

Housing - Die formed cold rolled sheet steel 20 gauge thick, matte white powder coating.

Reflectors - Cold rolled steel 0.030" thick precisely die formed, 95% reflective matte white painted.

Interior brackets - Die formed cold rolled sheet steel 20 gauge thick.

Center basket - Extruded Aluminum 0.07" nominal, matte white and lens made in clear PMMA precisely formed into optical micro-structures forms.

Side lenses - Frost impact acrylic lens 88% transmissive.

Drywall kit - Extruded Aluminum 0.07" nominal, matte white powder coating.

WEIGHT

Vega 1x4 - 17.18lbs.+3.08 lbs. (drywall kit) - 7.8kg+1.4kg (drywall kit)

CERTIFICATIONS

ETL - Rated for Indoor Dry/Damp locations. Conforms to UL Standard 1598 and certified to CAN/CSA Standard C22.2 No. 250.0.

Chicago plenum - City of Chicago Approved (CCEA)

IC rated - suitable for direct contact with insulation.