

VEGA 2x2 LED

SURFACE

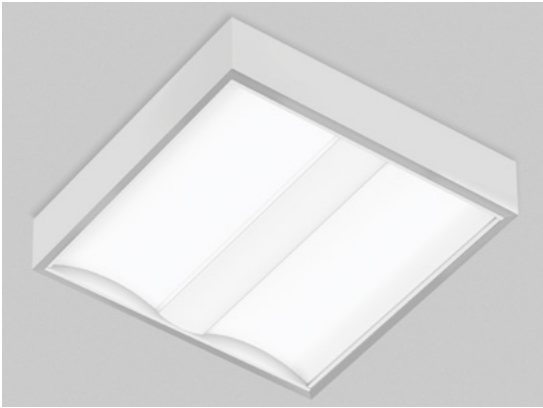

LUMENWERX
WWW.LUMENWERX.COM



Shown with MTO and HLO optics

DESCRIPTION

Vega is an efficient architectural LED troffer with a distinctive luminous shielding that features a median textured optic. Using advanced LED engines, Vega provides highly efficient illumination and offers comprehensive ceiling, electrical, and controls options in 2x2, 1x4, and 2x4 sizes. See separate spec sheets for other available mountings.

PROJECT: _____

APPROVED BY: _____

SIGNATURE: _____

TYPE	QTY



up to 115 lm/w performance

ORDER GUIDE

VEGS	22	MTO	HLO	LED			
LUMINAIRE ID	SIZE	CENTER OPTICS	SIDE OPTICS	LIGHT SOURCE	CRI	LUMEN PACKAGES	COLOR TEMP.
VEGS - vega surface	22 - 2'x2'	MTO - Median Textured Optic	HLO - High-Efficiency Lambertian Optic	LED - high performance LED	80 - 80CRI 90 - 90CRI	2300 - min. low output 2300lm 3200 - medium output 3200lm 4200 - max. high output 4200lm #### - other required lm	27 - 2700k 30 - 3000k 35 - 3500k 40 - 4000k

VOLTAGE	DRIVER	ELECTRICAL	SUR MOUNTING	FINISH	CONTROLS
120 - 120V 277 - 277V UNV - 120V-277V 347 - 347V (not available with Lutron)	D1 - 1% dimming 0-10V DA - Dali LTEA2W - Lutron 1% - 2 wire FF 120V LDE1 - Lutron Hi-lume 1% Eco LDE5 - Lutron 5% EcoSystem	1 - 1 circuit +EB - emergency battery pack +GTD### - generator transfer device, 120V or 277V	SUR - surface mount kit	W - matte white CF# - custom finish specify RAL#	<u>STANDALONE CONTROLS</u> OMS - Onboard Occupancy ODS - Onboard Daylight OCS - Onboard Occupancy & Daylight <u>CONNECTED CONTROLS</u> CCS() - LU-Lutron, EN-Enlighted, OS-Osram, CR-Crestron. To specify see information on page 4

See page 4 for ordering code detailed information

OPTIONS

FU - fuse
CU - custom

CROSS SECTION

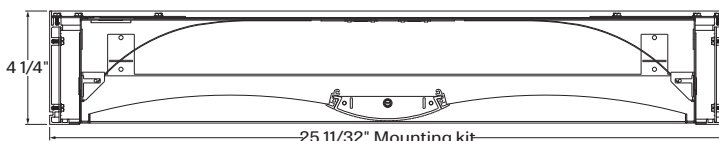

SUR - surface mount kit

OPTICS



HLO Side optics - High-Efficiency Lambertian

MTO Center optics - Median Textured Optic



VEGA 2x2 LED

SURFACE

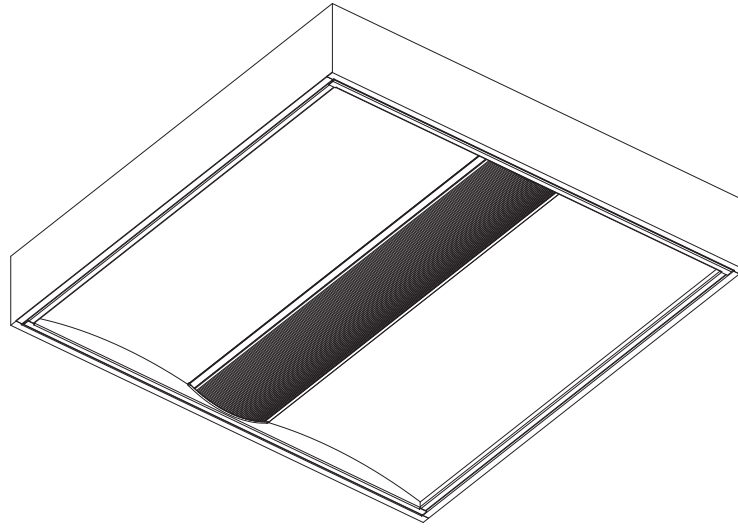

VEGA - SUR surface

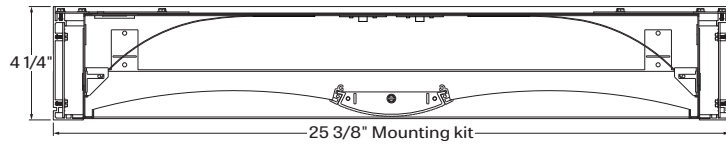

VEGA 2x2 LED

SURFACE

ELECTRICAL CIRCUITS

DIMMING 0-10V -

1 Circuit

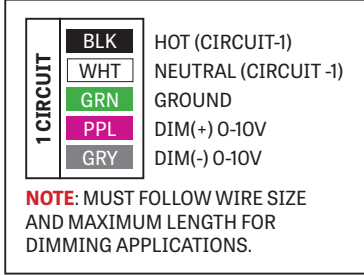

LUTRON 1% 2-wire FF 120V -

1 Circuit

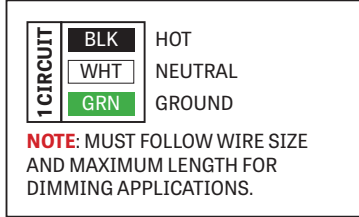

LUTRON LDE1 1%/LDE5 5% EcoSystem -

1 Circuit

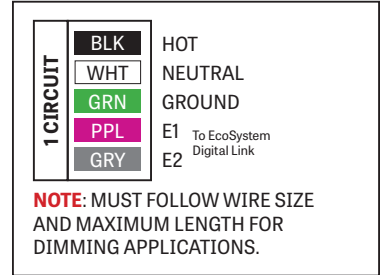

DIMMING 0-10V -

1 Circuit + Emergency Battery

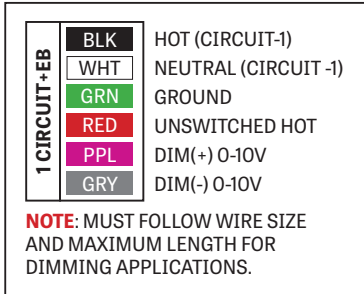

LUTRON 1% 2-wire FF 120V -

1 Circuit + Emergency Battery

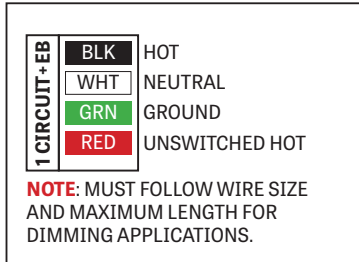

LUTRON LDE1 1%/LDE5 5% EcoSystem -

1 Circuit + Emergency Battery

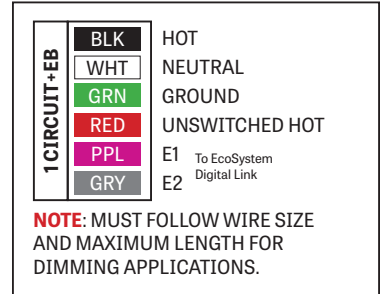

VEGA 2x2 LED

SURFACE

OPTICS

CENTER LENS - MEDIAN TEXTURED OPTIC (MTO) - Median Textured Optic (MTO) shielding consisting of ribbed diffusing center element.

SIDE LENS - HIGH EFFICIENCY LAMBERTIAN OPTIC (HLO) - Curved sides of diffusing 0.075" thick acrylic with 90% transmission and good source obscuration. Luminaire brightness is controlled by the flux-to-shielding area ratio in addition to offering a gentle gradient from center to edge.

LIGHT SOURCE - LED

Custom array of mid-flux LED's are mounted directly to the housing for optimal thermal performance. Available in 3000K, 3500K and 4000K with a minimum 80 CRI and an option for 90 CRI with elevated R9 value. Color consistency maintained to within 3 SDCM. LEDs operated at reduced drive current to optimize efficacy and lumen maintenance.

All LEDs have been tested in accordance with IESNA LM-80-08 and the results have shown L80 lumen maintenance greater than 60,000 hours. Absolute product photometry is measured and presented in accordance with IESNA LM-79, unless otherwise indicated.

LED output	Color Temp	Watts	Nominal Delivered Lumens	Efficacy LPW
low output	4000K	20	2300	115
medium output	4000K	29	3200	110
high output	4000K	40	4200	104

ELECTRICAL

Factory-set, adjustable output current LED driver with universal (120-277VAC) input. Dimmable from 100% to 1% with 0-10V dimming control. Rated life (90% survivorship) of 50,000 hours at 50°C max. ambient (and 70°C max. case) temperature. At maximum driver load: Efficiency>84%, PF>0.9, THD<20%. Other specifiable options include Lutron Hi-Lume 1% (specify 2-wire, or Ecosystem Dim-to-Off), Lutron 5-Series (5% Ecosystem), DMX (RDM compatible) and DALI protocol drivers. All of our standard 0-10V drivers are NEMA 410 compliant.

EMERGENCY

Factory installed long life high temperature recyclable Ni-Cad battery pack with test switch and charge indicator, minimum of 90 minutes operation, up to 1300 lumens (25°C) emergency lighting output. Recharge time of 24 hours.

MOUNTING OPTIONS

A separate kit for mounting fixtures directly to the ceiling surface. Kit is compatible with T-Bar, hard surface and drywall ceilings.

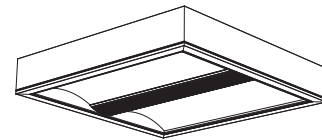
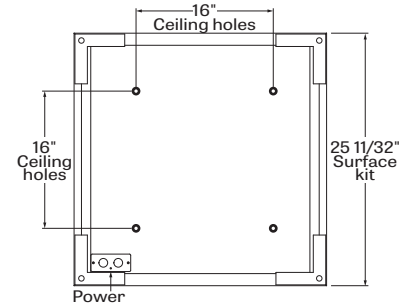

DF - drywall kit

FINISH

Interior reflectors - 95% reflective, matte white powder coating

Exterior - matte white powder coating. Custom finish is also available.

CONTROLS

LumenWerx offers several options for integrating occupancy and daylight harvesting controls in our luminaires.

STANDALONE CONTROLS

An integrated standalone sensor controls the luminaire in which it is installed. Depending on the length, more than one sensor may be necessary and may control the entire luminaire, or just a section of it. These controls operate independently. Unless otherwise agreed, location and functionality of the sensor within the luminaire are selected by LumenWerx.

Three types are available:

OMS: An integral Passive InfraRed (PIR) sensor turns luminaires on and off automatically with field-adjustable time out period. No wall control is used. Coverage pattern for large motion has a 12' diameter with the sensor mounted 8' above the floor; for small motion, the pattern has an 8' diameter. Typically, one sensor is required for every 10' of a continuous luminaire run.

ODS: An integral, daylight harvesting sensor with closed-loop operation dims the luminaire in which it is installed in order to compensate for available daylight. The sensor measures the combination of daylight and luminaire light reflected from horizontal surfaces below the luminaire. Initial onsite calibration is required via the use of provided remote control.

OCS: Both an occupancy and a daylight sensor are installed in the luminaire.

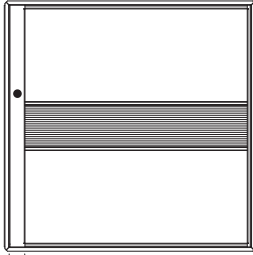

1 1/2"
Location of an Onboard control

CONNECTED CONTROLS

With Connected Controls, sensors or nodes installed in the luminaire form part of a larger control system infrastructure from manufacturers such as: Lutron*, Enlighted, Osram ENCELIUM, Acuity nLight, Crestron and others. These connected controls allow for a scalable system providing features like occupancy and daylight control, manual control, scheduling and configuration of various zones and scenes. Energy reporting and system monitoring are also possible. Specific capabilities depend on the control system being used.

LumenWerx installs the components (sensors, nodes, power packs, etc) which may be supplied to us by a third party, or procured directly by LumenWerx, depending on the control system manufacturer.

LumenWerx is solely responsible for the installation of specified components; the controls manufacturer is responsible for performance of the control system.

To indicate a LumenWerx luminaire with Connected Controls, identify the specific onsite control system to be integrated into the luminaires using the ordering code. Due to the diversity of components, you must contact controls@lumenwerx.com to assure complete compatibility with intended control system and to fully specify the luminaire.

Complete control specifications, sensor/node/power pack layout, and narrative for the control system are required for LumenWerx to create shop drawings and submittals.

* Lumenwerx offers a Lutron Vive-Enabled fixture option using either the DFCSJ-OEM-OCC (OCS Option) or DFCSJ-OEM-RF (wireless only, no sensor) Integral Fixture Modules and a DALI or EcoSystem LED driver based on customer dimming requirements.

Please contact our controls department at controls@lumenwerx.com for further assistance.

CONSTRUCTION

Housing - Die formed cold rolled sheet steel 20 gauge thick, matte white powder coating.

Reflectors - Cold rolled steel 0.030" thick precisely die formed, 95% reflective matte white painted.

Interior brackets - Die formed cold rolled sheet steel 20 gauge thick.

Center basket - Extruded Aluminum 0.07" nominal, matte white and lens made in clear PMMA precisely formed into optical micro-structures forms.

Side lenses - Frost impact acrylic lens 88% transmissive.

Surface kit - Extruded Aluminum 0.07" nominal, matte white or aluminum powder coating. Custom finishes are also available.

WEIGHT

Vega 2x2 - 16.08lbs.+5.51lbs. - 7.3kg+2.5kg

CERTIFICATIONS

ETL - Rated for Indoor Dry/Damp locations.

Conforms to UL Standard 1598 and certified to CAN/CSA Standard C22.2 No. 250.0.

DLC - Testing to DLC requirements, for this product, have been completed by an Accredited Laboratory and certified by DLC.

Lighting facts - testing products and reporting performance results according to industry standards.

WARRANTY

LumenWerx provides a five-year limited warranty of electrical and mechanical performance of the luminaires, including the LED boards, drivers, and auxiliary electronics. LumenWerx will repair or replace defective luminaires or components at our discretion, provided they have been installed and operated in accordance with our specifications. Other limitations apply, please refer to the full warranty on our website.

VEGA 2x2 LED

SURFACE

2300 LUMEN AT 80CRI - LOW OUTPUT

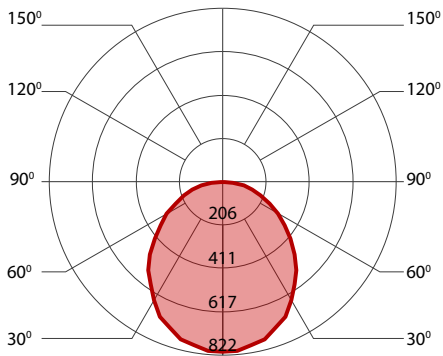

PERFORMANCE

LED output	Color Temp	Watts	Nominal Delivered Lumens	Efficacy LPW
low output	2700K	22	2300	105
low output	3000K	21	2300	108
low output	3500K	21	2300	111
low output	4000K	20	2300	115



3200 LUMEN AT 80CRI - MEDIUM OUTPUT

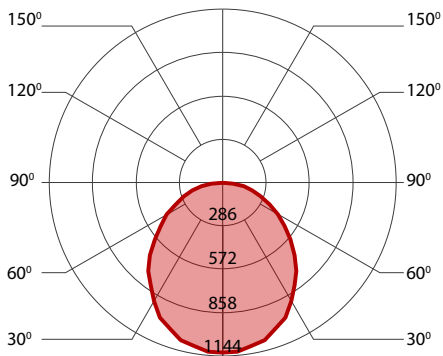

PERFORMANCE

LED output	Color Temp	Watts	Nominal Delivered Lumens	Efficacy LPW
medium output	2700K	31.5	3200	101
medium output	3000K	31	3200	103
medium output	3500K	30	3200	106
medium output	4000K	29	3200	110



4200 LUMEN AT 80CRI - HIGH OUTPUT

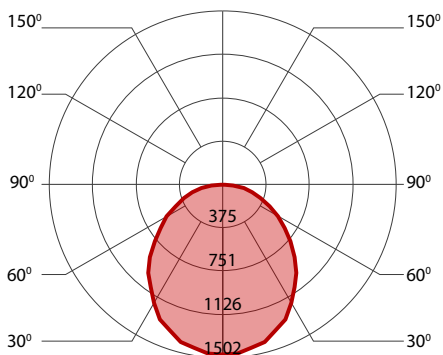

PERFORMANCE

LED output	Color Temp	Watts	Nominal Delivered Lumens	Efficacy LPW
high output	2700K	44	4200	96
high output	3000K	43	4200	98
high output	3500K	42	4200	101
high output	4000K	40	4200	104

