

MILL Ø14" SURFACE

PROJECT PROJET
SPEC TYPE
NOTES



SHADE FINISH FINI ABAT-JOUR



ADDITIONAL PREMIUM COLORS AVAILABLE – SEE ACOUSTIC MATERIAL COLOR OPTIONS PAGE

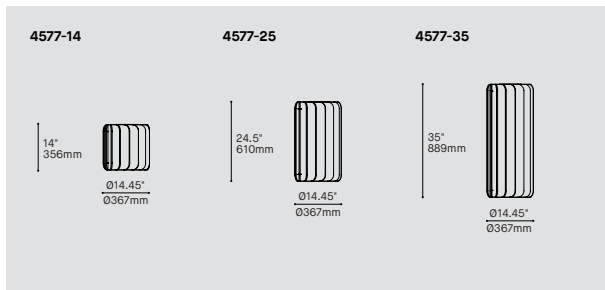

ORDERING SPECIFICATION SPÉCIFICATION DE COMMANDE

CODE

MODEL MODÈLE

4577-14 MILL 14"
4577-25 MILL 25"
4577-35 MILL 35"

LIGHT SOURCE SOURCE LUMINEUSE

LED.LO LOW OUTPUT
LED REGULAR OUTPUT
LED.HO HIGH OUTPUT

COLOR TEMPERATURE TEMPÉRATURE DE COULEUR

27* 2700K
30 3000K
35 3500K
40 4000K

* LONGER LEAD TIME MAY APPLY, PLEASE CONTACT YOUR EUREKA REPRESENTATIVE

COLOR RENDERING INDEX (CRI) INDICE DE RENDU DE COULEUR (IRC)

80 80+ CRI
90* 90+ CRI

* LONGER LEAD TIME MAY APPLY, PLEASE CONTACT YOUR EUREKA REPRESENTATIVE

VOLTAGE VOLTAGE

120V 120 VOLT
277V 277 VOLT

CONTROL OPTION OPTION DE CONTRÔLE

DV 0-10V DIMMING (120V-277V)
DP PHASE DIMMING (120V ONLY)
NLTAIR2* NLIGHT AIR CONTROL GEN 2
NLIGHT* NLIGHT WIRED CONTROL

* NLIGHT INTEGRATION REQUIRES A REMOTE POWER PACK (39NLAA FO R NLTAIR2 OR 39NLWA FOR NLIGHT).
* EMERGENCY BATTERY NOT AVAILABLE WITH NLIGHT OPTIONS
* REFER TO NLIGHT GUIDE AND INSTALLATION SHEET FOR ALL REQUIREMENTS.

EMERGENCY BATTERY BATTERIE D'URGENCE

EM DRIVER BOX INCLUDED, INSTALLED REMOTELY, SEE EM GUIDE FOR DETAILS.

EMB* EMERGENCY BATTERY FOR REMOTE BOX

* 3981EA ACCESSORY IS REQUIRED

SHADE FINISH FINI ABAT-JOUR

ABF AZURE BLUE FELT	BYF BANANA YELLOW FELT	REF RED FELT
AWF ARCTIC WHITE FELT	CHF CHARCOAL FELT	SGF SILVER GRAY FELT
BBF BASIC BLACK FELT	NBF NAVY BLUE FELT	TGF TITANIUM GRAY FELT
BOF BLOOD ORANGE FELT	OBF OCEAN BLUE FELT	ZFF ZINFANDEL FELT
BTF BATTLESHIP GRAY FELT	PGF PEAR GREEN FELT	
PREMIUM*	PLEASE SPECIFY PREMIUM COLOR CODE – SEE ACOUSTIC MATERIAL COLOR OPTIONS PAGE	

* LONGER LEAD TIME MAY APPLY, PLEASE CONTACT YOUR EUREKA REPRESENTATIVE

DIFFUSER FINISH FINI DIFFUSEUR

WH

WH WHITE

ACCESSORY ACCESSOIRE

ALL ACCESSORIES ARE AVAILABLE FOR ADVANCE SHIPPING

39NLAA* NLIGHT AIR GEN 2 REMOTE POWER PACK

39NLWA* NLIGHT WIRED REMOTE POWER PACK

* FOR CHICAGO PLENUM INSTALLATION, PLEASE CONTACT YOUR EUREKA REPRESENTATIVE .

EMERGENCY BATTERY ACCESSORY ACCESSOIRE BATTERIE D'URGENCE

3981EA ELECTRICAL BOX FOR EMB EMERGENCY BATTERY

PRODUCT CHARACTERISTICS CARACTÉRISTIQUES DU PRODUIT



DESIGN: With its fifteen acoustic panels shade, Mill offers an original soft aesthetic and atmosphere enhancing functionality. With multiple sizes, colors and mounting options as well as optional uplight, Mill will help with volume control while adding a stunning design element to the decor.

INSTALLATION: Easy and quick to install surface mounted system ideal for low ceiling installations. Also available as pendant.

LIGHT SOURCE: This pendant offers powerful and evenly diffused lighting with a COB light source. Phase or 0-10V dimming offered.

SHADE: The custom CNC rigid felt acoustic panels are available in multiple color. Composed of at least 40% of recycled polyethylene bottles (PET) which make them recyclable and orderless.

CERTIFIED: c-CSA-us

Acoustic Material Color Options for Mill



Standard colors



ABF
Azure Blue



AWF
Arctic White

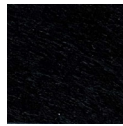

BBF
Basic Black



BOF
Blood Orange

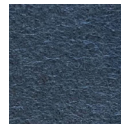

BTF
Battleship Gray



BYF
Banana Yellow



CHF
Charcoal

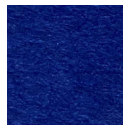

NBF
Navy Blue

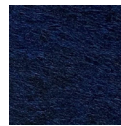

OBF
Ocean Blue

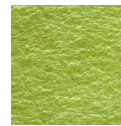

PGF
Pear Green



REF
Red



SGF
Silver Gray

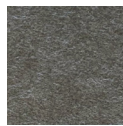

TGF
Titanium Gray

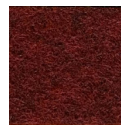

ZFF
Zinfandel

Premium colors



BGF
Bubble Gum



BKF
Bark Brown



DBF
Denim Blue

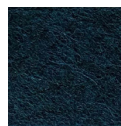

DTF
Deep Teal Green

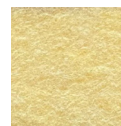

DYF
Daisy Yellow



GGF
Grass Green



LBF
Light Beige



LGF
Lime Green

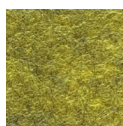

MGF
Moss Green

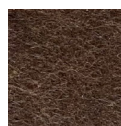

OAF
Oak Brown



PBF
Peanut Brown



PNF
Pinot Noir

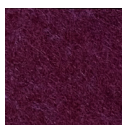

PPF
Plum Purple



SBF
Sky Blue



TOF
Tangerine Orange



TPF
Tulip Purple

- Premium colors carry extended lead times. Additional fees may apply for expedited lead times. Please consult factory.
- Due to the dye process, colors may vary slightly from batch to batch.

MILL Ø14"

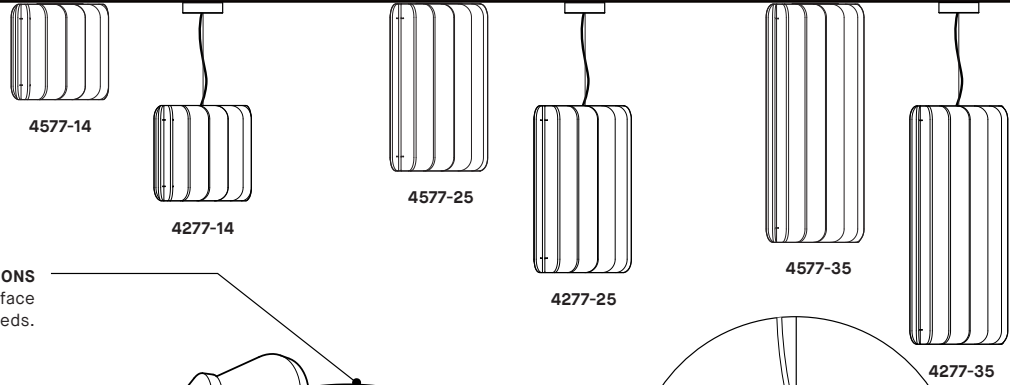

TWO MOUNTING OPTIONS
The fixture can be suspended or surface mounted depending of the space needs.



NOISE REDUCTION
The arrangement of the 15 vertical panels increases the effective surface area of sound absorbing material optimizing the acoustic performance of the luminaire.
The panels are available in 30 colors.
For all color options, refer to the Acoustic Material Color Options page.

RECYCLED PANELS
Custom CNC cut panels composed of polyester fibers (PET) with 42% recycled content. 100% recyclable, non-toxic, non-allergenic and non-irritable. The material is also low VOC and fire rated.



FLEXIBLE ENGINES
LOW, REG and HIGH output light engine allows for a wide range of applications.

ACOUSTIC COLUMNS
Mill is hollow and it benefits the sound absorption capacities. The sound gets trapped inside the luminaire and is absorbed by the felt blades, but from within.

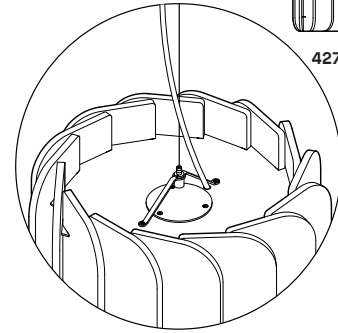

4277DI

TRUE UPLIGHT
The suspended version offers an optional second light source with a great uplight performance. Both light sources can be dimmed separately. We recommend a minimum suspension of 22" for a diffused uplight.

CLEANING

A proper and regular cleaning will help extend the lifespan of acoustic products. Remove dust with a vacuum cleaner and light stains with a damp cloth. For greasy and deep stains, a professional dry clean is recommended. Do no use any abrasive, soap, or chemical cleaner.

PRODUCT SPECIFICATION

Ø14" DIRECT

Ø14" INDIRECT

PERFORMANCE	LO	REG	HO	REG	HO
SYSTEM WATTAGE	14.4W	31.8W	50W	14.4W	20.6W
DELIVERED LUMENS (4000K - SGF)	884LM	1732LM	2626LM	987LM	1342LM
EFFICACY	61LM/W	54LM/W	52LM/W	68LM/W	65LM/W

* Expect a 10% decrease in performance for CHF, REF and NBF (direct).

OTHER INFORMATIONS	14"	25"	35"	14"	25"	35"
LUMINAIRE'S WEIGHT	11.3LBS	13LBS	15.2LBS	11.8LBS	13.5LBS	15.7LBS
L70 (LUMEN MAINTENANCE) DIRECT		> 63600 HRS		> 63600 HRS		
L70 (LUMEN MAINTENANCE) INDIRECT		N/A		> 55000 HRS		
FELT	HIGH DENSITY 9MM POLYESTER FELT					
ACOUSTIC	ACOUSTIC MATERIAL RATED AT 0.75 N					
FIRE RATING	ASTM E84-13 (FELT MATERIAL ONLY)					

WELL & LEED STANDARD REQUIREMENTS

MAX. LUMINANCE 45°-90° OF NADIR	2180 CD/M²
LIGHT QUALITY	R9 > 50 (90 CRI OPTION)
FLICKERING TOLERANCE	LOW FLICKER, COMPLIANT TO CALIFORNIA TITLE 24

EFFICACY MULTIPLIERS

CRI	CCT	FACTOR
80+	4000K	1.14
80+	3500K	1.11
80+	3000K	1.08
80+	2700K	1.04
90+	4000K	1.00
90+	3500K	0.98
90+	3000K	0.94
90+	2700K	0.91

LIGHT DISTRIBUTION



Ø14" DIRECT

Ø14" DIRECT/INDIRECT

0



Visit our website for warranty terms and conditions.



TECHNICAL DATA

MILL Ø14"

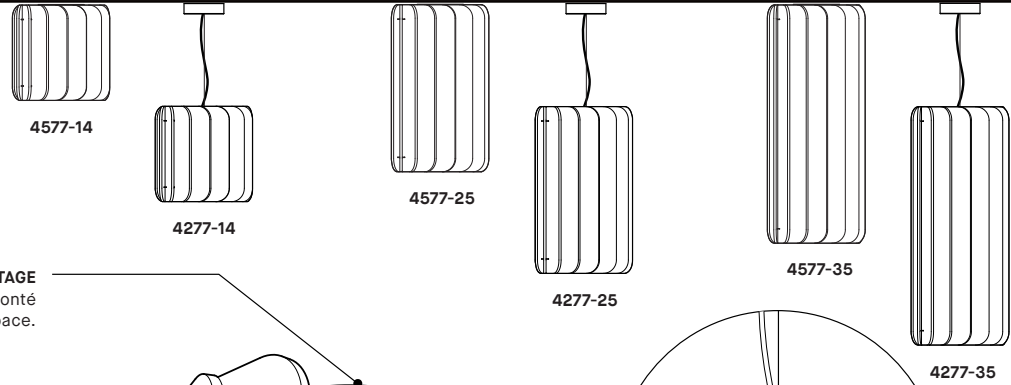

DEUX OPTIONS DE MONTAGE

Le luminaire peut être suspendu ou monté en surface selon les besoins de l'espace.



ATTÉNUATION DU BRUIT

La superposition des 15 panneaux verticaux augmente la surface effective du matériau insonorisant, optimisant les performances acoustiques du luminaire. Les panneaux sont disponibles en 30 couleurs. Pour toutes options de couleurs, consulter la page d'options de couleurs de matérielle acoustique.

PANNEAUX RECYCLÉS

Panneaux composés de fibres de polyester (PET) avec 42% de matière recyclées. 100% recyclable, non-toxique, non-allergène et non-irritable. Faible teneur en COV et résistance au feu.



SOURCES POLYVALENTES

Source LOW, REG et HO permettent une grande variété d'applications.

COLONNES ACOUSTIQUES

Mill est creux et profite des capacités d'absorption acoustique. Le son est emprisonné à l'intérieur du luminaire et est absorbé par les panneaux de feutre, mais de l'intérieur.

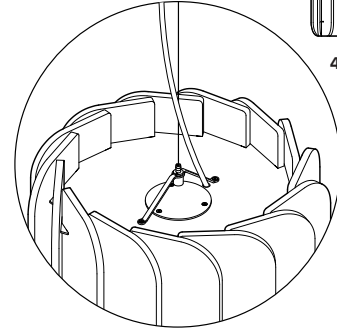

4277DI

SOURCE INDIRECTE PUISSANTE

La version suspension offre en option une seconde source lumineuse pour offrir un éclairage indirect performant. Les deux sources peuvent se régler séparément. Nous recommandons une suspension minimum de 22" pour avoir une lumière indirecte diffuse.

NETTOYAGE

Un nettoyage approprié et régulier contribuera à prolonger la durée de vie des produits acoustiques. Enlever la poussière avec un aspirateur et les taches légères avec un linge humide. Pour les taches importantes ou grasses, un nettoyage à sec est recommandé. Ne pas utiliser de produits abrasifs, de savon ou de produits nettoyants chimiques.

SPÉCIFICATION PRODUIT	Ø14" DIRECT			Ø14" INDIRECT		
	LO	REG	HO	REG	HO	
PERFORMANCE						
PUISSANCE TOTALE	14.4W	31.8W	50W	14.4W	20.6W	
LUMENS RÉELS DIRECT (4000K - SGF)	884LM	1732LM	2626LM	987LM	1342LM	
LUMENS RÉELS INDIRECT (4000K - SGF)	61LM/W	54LM/W	52LM/W	68LM/W	65LM/W	
EFFICACITÉ						
* Prévoir une diminution de 10% des performances pour le CHF, REF et NBF (direct).						
AUTRES INFORMATIONS	14"	25"	35"	14"	25"	35"
POIDS DU LUMINAIRE	11.3LBS	13LBS	15.2LBS	11.8LBS	13.5LBS	15.7LBS
L70 (MAINTENANCE DE LA LUMIÈRE) DIRECT		> 63600 H			> 63600 H	
L70 (MAINTENANCE DE LA LUMIÈRE) INDIRECT		N/A			> 55000 H	
FEUTRE ACOUSTIQUE	FEUTRE DE POLYESTER HAUTE DENSITÉ 9MM					
RÉSISTANCE AU FEU	MATÉRIEL ACOUSTIQUE GRADÉ À 0.75 N					
	ASTM E84-13 (MATÉRIEL FEUTRE SEULEMENT)					

CRITÈRES DE CERTIFICATION WELL & LEED	
MAX. LUMINANCE 45°-90° NADIR	2180 CD/M²
QUALITÉ DE LA LUMIÈRE	R9 > 50 (OPTION 90 IRC)
TOLÉRANCE DE CLIGNOTEMENTS	PEU DE CLIGNOTEMENT (CONFORME À CALIFORNIA TITLE 24)

FACTEUR D'EFFICACITÉ		
IRC	CCT	FACTEUR
80+	4000K	1.14
80+	3500K	1.11
80+	3000K	1.08
80+	2700K	1.04
90+	4000K	1.00
90+	3500K	0.98
90+	3000K	0.94
90+	2700K	0.91

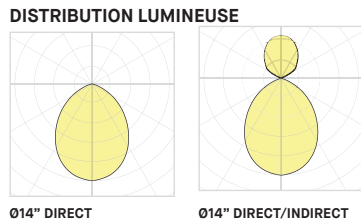

Visitez notre site Web pour les termes et conditions.



DONNÉES TECHNIQUES

JUNCTION BOX 3981E

PROJECT PROJÉT
SPEC TYPE
NOTES



ORDERING SPECIFICATION SPÉCIFICATION DE COMMANDE CODE

MODEL MODÈLE		
3981EA	APPROX. 10W MAX EMERGENCY BACKUP POWER	
3981EB	APPROX. 5W MAX EMERGENCY BACKUP POWER	

PRODUCT CHARACTERISTICS CARACTÉRISTIQUES DU PRODUIT

- DESIGN:** Remote junction box and cover with an emergency backup driver. Features matching wires and labelling to simplify installation. Is required to complete luminaires ordered with EMB remote emergency box option (selected models, refer to specification sheets. Other models possible upon request). Available in several power outputs, selected according to the luminaire power.
- STRUCTURE:** Die-stamped 16 gauge grey painted steel. Knockouts on all 4 sides from 1/2" to 1-1/4".
- CERTIFIED:** c-CSA-us, UL, RoHS, NEMA Type 1, FCC
- CONCEPTION:** Boîte de jonction à distance avec couvercle avec batterie d'urgence intégré. Contient des fils avec couleurs et étiquetage pour simplifier l'installation. Requis pour compléter un luminaire commandée avec l'option EMB (voir pages de spécification pour produits avec l'option EMB. Autres produits possibles sur demande). Disponible en plusieurs puissances, sélectionnées en fonction du luminaire.
- STRUCTURE:** Acier plié de 16 jauge peinturé gris avec coins soudés. Débouchures sur 4 côtés 1/2" à 1-1/4".
- CERTIFIÉ:** c-CSA-us, UL, RoHS, NEMA Type 1, FCC

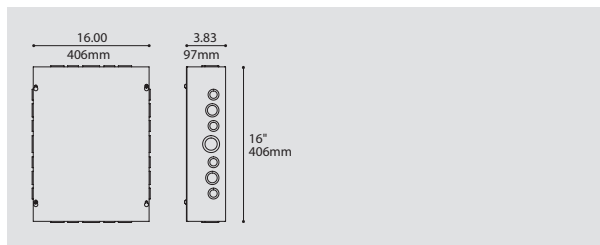

INSTALLATION SUMMARY SOMMAIRE D'INSTALLATION

STEP 1 ÉTAPE 1

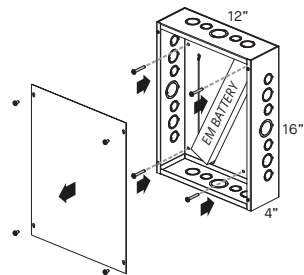

Remove cover and fasten box remotely to a wall or a ceiling.
Enlever le couvercle et fixer la boîte à distance sur un mur ou un plafond.

STEP 2 ÉTAPE 2

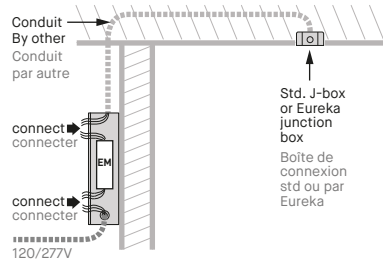

Run conduit from box to junction box of luminaire. Conduit must have a minimum of 5 wires with wire gauge and maximum distance as per EM driver distance chart. Connect EM driver to conduit wires and ac branch circuit. Faites passer le conduit de la boîte EM à la boîte de connexion du luminaire. Consulter le tableau de "distance maximale" disponible dans la feuille d'installation. Branchez la batterie EM avec les fils du conduit ainsi que la ligne 120V ou 277V.

STEP 3 ÉTAPE 3

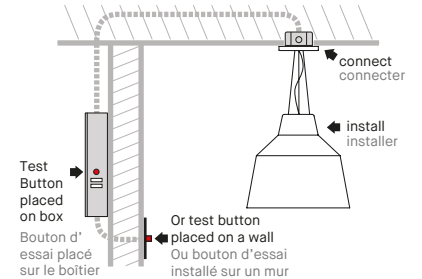

Install luminaire & connect its wires to conduit. Install test button on wall or box (wall plate not supplied). Installer le luminaire & connecter les fils au conduit. Installer le bouton d'essai sur le mur ou boîtier (plaque murale non fournie).

REFER ALSO TO INSTALLATION DRAWING AND EM GUIDE FOR MORE INFORMATION.
CONSULTEZ LE DESSIN D'INSTALLATION ET LE GUIDE EM POUR PLUS D'INFORMATIONS.



SPECIFICATION

3981E REMOTE EMERGENCY BOX KIT - IOTA EM DRIVER

SAFETY GUIDELINES :

- > Follow safety instructions and guidelines of EM battery/driver manufacturer for the specific model.
- > Install by qualified personnel in accordance with the National Electrical Code and local regulations.
- > Turn off power supply before installation or servicing the fixture.

EMB LOCATION :

- > The 3981E box connects to a luminaire ordered with an EMB option (which has specific EM WIRING).
- > Consult our chart for maximum remote distance of EM battery to luminaire leds.
- > Establish desired location for EMB box & EM test button on box or on a wall.

EM Remote Distance Chart
Maximum distance EM battery to Luminaire LEDs (Ft)

MAX EM BOX DISTANCE (Ft)	CONDUIT WIRE GAUGE (AWG)							
	10	12	14	16	18	20	22	
LUMINAIRE	200mA	1043'	651'	413'	259'	163'	103'	65'
DRIVER	350mA	596'	372'	236'	148'	93'	59'	37'
OUTPUT	500mA	417'	261'	165'	104'	65'	41'	26'
CURRENT*	700mA	298'	186'	118'	74'	47'	29'	18'
(Amps)	1000mA	209'	130'	83'	52'	33'	21'	13'
*Contact Eureka	1400mA	149'	93'	59'	37'	23'	15'	9'
	2000mA	104'	65'	41'	26'	16'	10'	6'
	3000mA	70'	43'	28'	17'	11'	7'	4'

EMB PLACEMENT EXAMPLES :

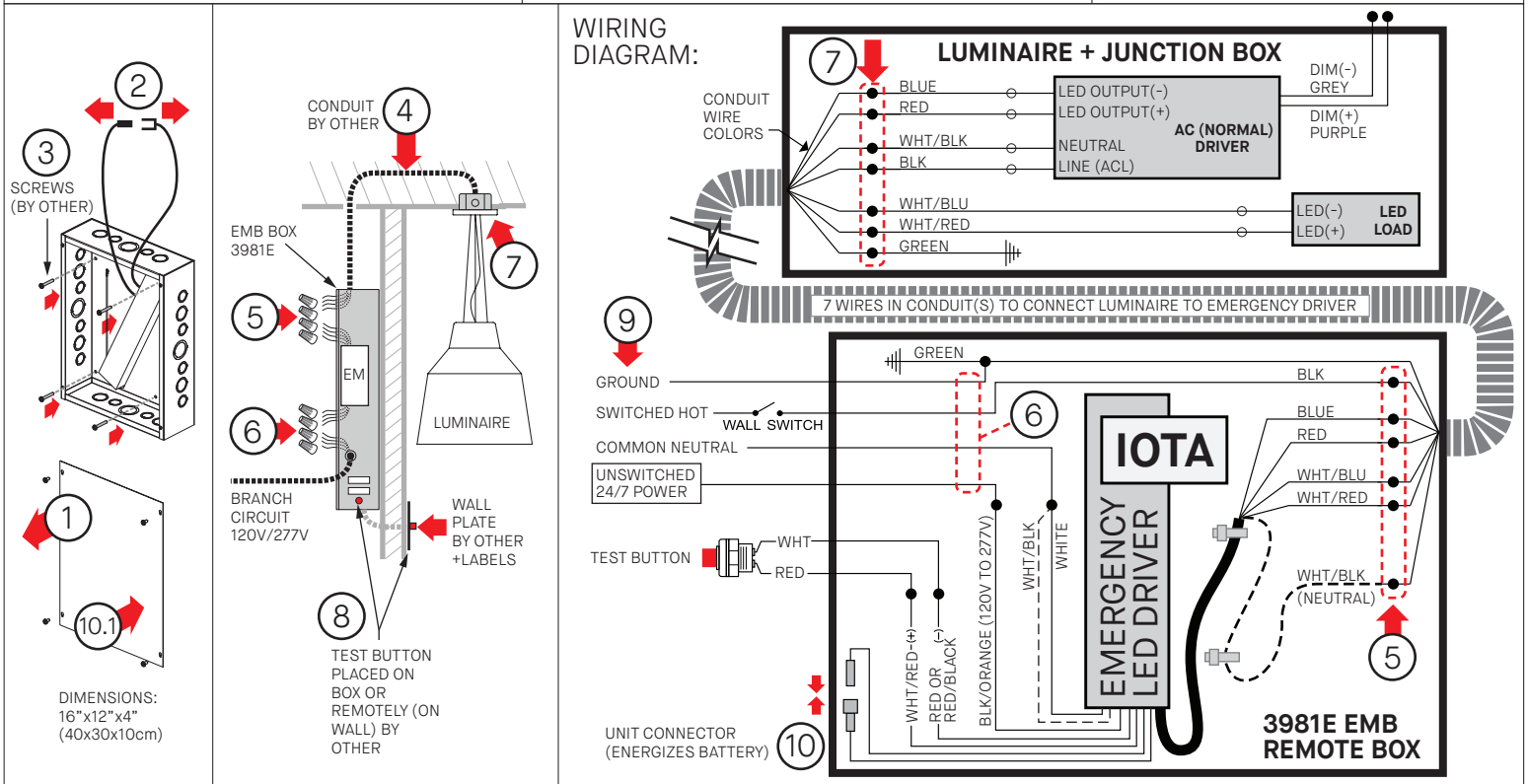
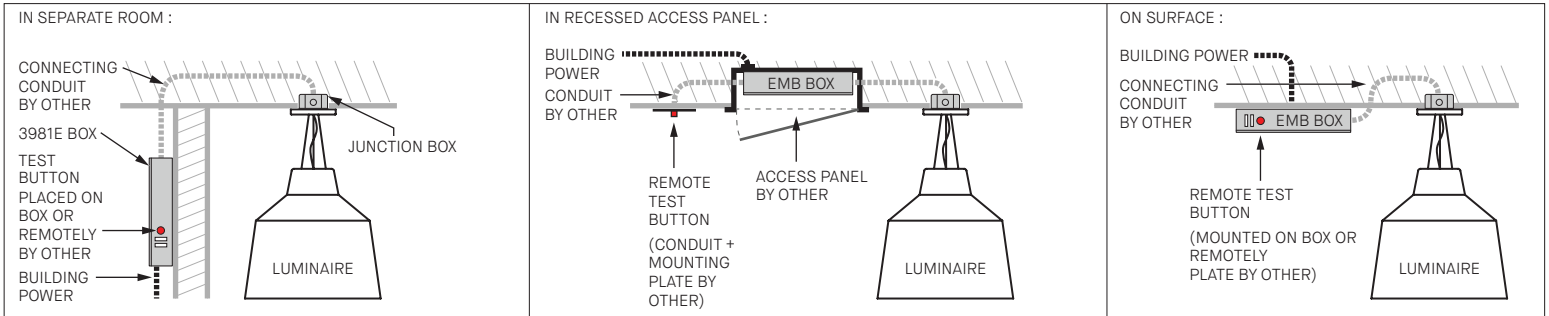

INSTALLATION

- 1 - REMOVE BOX COVER.
- 2 - IF CONNECTED, DISCONNECT THE EM BATTERY 'UNIT CONNECTOR' (WHITE).
- 3 - SCREW BOX TO MOUNTING SURFACE (SCREWS NOT SUPPLIED)
- 4 - RUN CONDUIT FROM EMB BOX TO ELECTRICAL JUNCTION BOX OF LUMINAIRE. CONDUIT MUST HAVE MIN. 7 WIRES AND WIRE GAUGE AS PER DISTANCE CHART.
- 5 - CONNECT CONDUIT WIRES TO EM BATTERY AS PER WIRING DIAGRAM.
CAREFULLY NOTE WHICH WIRE COLORS ARE CONNECTED TOGETHER ON EACH END.
- 6 - CONNECT BATTERY TO AC BRANCH CIRCUIT : GROUND, NEUTRAL, 24/7 UNSWITCHED LINE (HOT) AND SWITCHED LINE (ON SAME CIRCUIT AS LUMINAIRE ON/OFF CONTROL).
- 7 - INSTALL SPECIFIC EM LUMINAIRE, CONNECT WIRES TO CONDUIT USING THE SAME CORRESPONDING COLORS NOTED AT THE EM BATTERY-CONDUIT CONNECTION.
- 8 - INSTALL EM BATTERY TEST BUTTON IN DESIRED LOCATION. WALL PLATE BY OTHER. ADD LABELS "PUSH TO TEST" & CHARGING INDICATOR LIGHT".

- 9 - SWITCH ON AC POWER.
- 10 - JOIN THE EM BATTERY CONVERTOR CONNECTOR. 10.1 - INSTALL BOX COVER.
- 11 - IF EMB IS FAR FROM THE LUMINAIRE, IDENTIFY TO WHICH LUMINAIRE IT IS CONNECTED.

AT THIS POINT POWER SHOULD BE CONNECTED TO BOTH THE AC DRIVER AND THE EMERGENCY DRIVER & TEST/CHARGE LIGHT SHOULD ILLUMINATE, INDICATING BATTERY IS CHARGING.

TESTING & EM DRIVER/BATTERY MAINTENANCE:

CONDUCT A SHORT-TERM DISCHARGE TEST AFTER THE EMERGENCY DRIVER HAS BEEN CHARGED FOR MINIMUM ONE HOUR. CHARGE FOR 24 HOURS BEFORE CONDUCTING A LONG-TERM DISCHARGE TEST.

FOLLOW GUIDELINES FROM THE EM DRIVER/BATTERY MANUFACTURER INSTRUCTIONS FOR THE REQUIRED PERIODIC TESTING AND MAINTENANCE GUIDELINES.

3981E BOÎTE D'URGENCE À DISTANCE - DRIVER EM IOTA

DIRECTIVES DE SÉCURITÉ:

- > Suivre les consignes de sécurité et les directives d'installation du fabricant de la batterie d'urgence.
- > Installer par du personnel qualifié conformément au code électrique national et local.
- > Fermer l'alimentation avant l'installation ou l'entretien.

EMPLACEMENT :

- > Cette boîte 3981E se connecte à un luminaire commandé avec l'option EMB (qui a du filage spécifique).
- > Consulter le tableau pour la distance maximale de la batterie d'urgence aux DELs du luminaire.
- > Déterminer l'emplacement souhaité pour la boîte EMB et le bouton de test d'urgence.

EXEMPLES D'EMPLACEMENT:

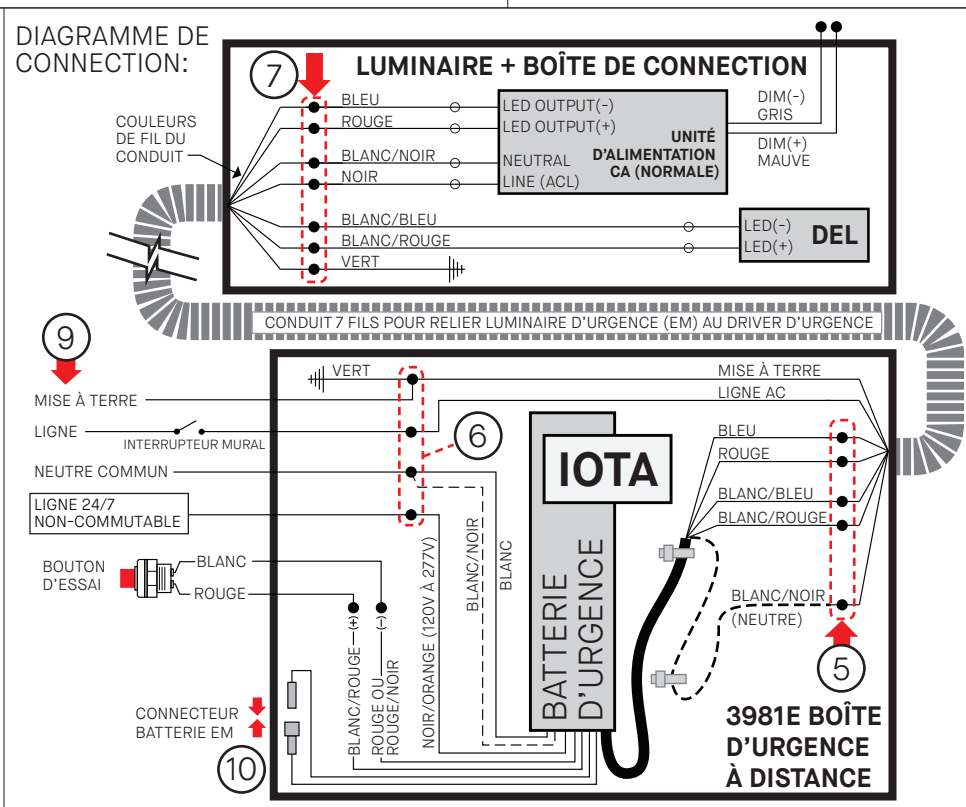
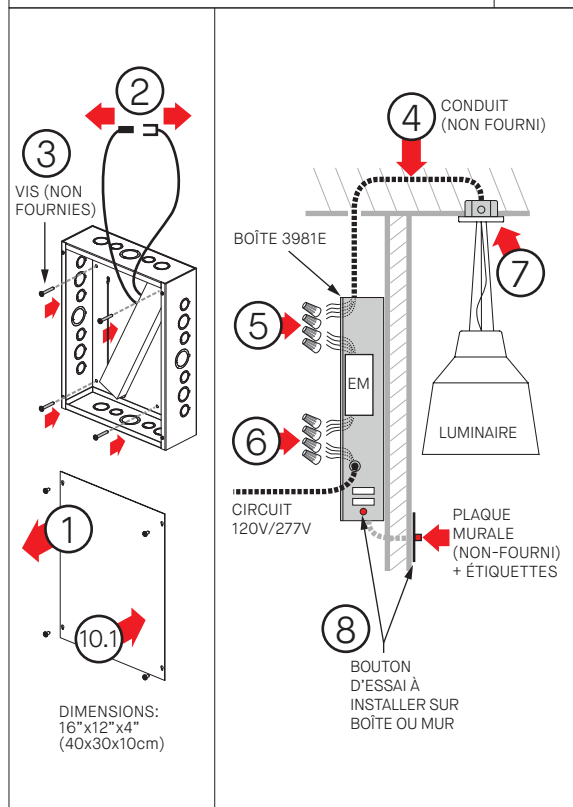
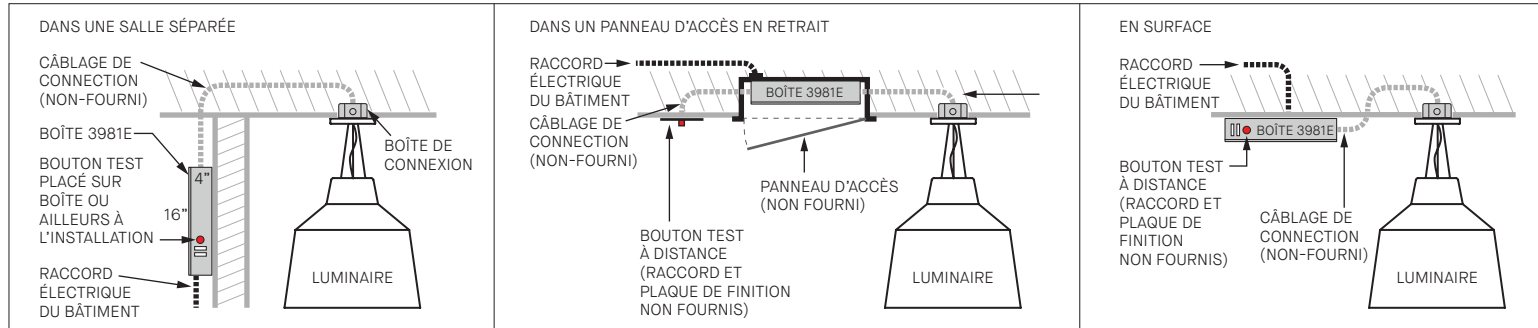

Charte de distance d'installation EM
Distance maximale entre Batterie d'urgence et DELs du luminaire (Pi)

DISTANCE MAX D'INSTALLATION (Pi)	GAUGE DE FILS DU CONDUIT (AWG)							
	10	12	14	16	18	20	22	
COURANT	200mA	1043'	651'	413'	259'	163'	103'	65'
ALIMENTATION DU LUMINAIRE*	350mA	596'	372'	236'	148'	93'	59'	37'
300mA	500mA	417'	261'	165'	104'	65'	41'	26'
700mA	298'	186'	118'	74'	47'	29'	18'	
1000mA	209'	130'	83'	52'	33'	21'	13'	
*Contacter Eureka	1400mA	149'	93'	59'	37'	23'	15'	9'
	2000mA	104'	65'	41'	26'	16'	10'	6'
	3000mA	70'	43'	28'	17'	11'	7'	4'

INSTALLATION

- 1 - DÉVISSER LE COUVERCLE.
- 2 - DÉCONNECTER LE CONNECTEUR BLANC DE BATTERIE EM (UNIT CONNECTOR).
- 3 - FIXER LA BOÎTE SUR LE MUR/PALAFOND AVEC VIS (NON FOURNIES)
- 4 - PASSER DU CONDUIT DU EMB VERS LA BOÎTE DE CONNEXION ÉLECTRIQUE DE LUMINAIRE. LE CONDUIT DOIT AVOIR 7 FILS AVEC GAUGE DE FIL SELON CHARTRE DE DISTANCE.
- 5 - CONNECTER LES FILS DE CONDUIT À LA BATTERIE EM SELON LE SCHÉMA DE CÂBLAGE.
- 6 - CONNECTER LA BATTERIE AU CIRCUIT DE DÉRIVATION AC (FILS: MISE A LA TERRE, NEUTRE, LIGNE & LIGNE SANS INTERRUPTEUR 24H/7* (*DOIT ETRE LE MEME CIRCUIT QUE LE CONTROLE DU LUMINAIRE)).
- 7 - INSTALLER LUMINAIRE SPÉCIFIQUE EM, CONNECTER LES FILS AU CONDUIT AVEC MÊMES COULEURS CORRESPONDANTES DE LA BATTERIE EM AUX FILS DE CONDUIT.
- 8 - INSTALLEZ LE BOUTON D'ESSAI DE BATTERIE EM DANS L'ENDROIT SOUHAITÉ (PLAQUE MURALE PAR AUTRE). COLLER ÉTIQUETTES "PUSH TO TEST" & CHARGING INDICATOR LIGHT".

- 9 - ALIMENTER LE CIRCUIT AC.
- 10 - JOINDRE CONNECTEUR BLANC DE BATTERIE EM. 10.1 - INSTALLER COUVERCLE DE BOITE.
- 11 - SI LE EMB EST LOIN DU LUMINAIRE, IDENTIFIER À QUEL LUMINAIRE IL EST CONNECTÉ.

A CE STADE, L'ALIMENTATION DEVRAIT ÊTRE CONNECTÉE À L'UNITÉ D'ALIMENTATION AC ET LA BATTERIE D'URGENCE ET LA LUMIÈRE DE TEST/CHARGE S'ILLUMINE, INDIQUANT QUE LA BATTERIE SE CHARGE.

ESSAIS & ENTRETIEN DE LA BATTERIE:

FAITES UN TEST DE DÉCHARGE À COURT TERME APRÈS AVOIR CHARGÉ LA BATTERIE D'URGENCE AU MINIMUM UNE HEURE. CHARGEZ 24 HEURES AVANT D'EFFECTUER UN TEST DE DÉCHARGE À LONG TERME.

SUIVRE LES DIRECTIVES DU FABRICANT DE BATTERIE / CONDUCTEUR EM (SITE WEB) POUR LES DIRECTIVES PÉRIODIQUES REQUISES EN MATIÈRE DE TEST ET D'ENTRETIEN.