

PRIME

PRIME 6" LED ARCHITECTURAL ROUND FLANGED OPEN/ACCENT TRIM ADJUSTABLE

JOB INFORMATION	TYPE:
	CATALOG NO.:
	PROJECT NAME:
	COMMENTS:
	PREPARED BY:

USE OF PRODUCT

The 6" Prime Adjustable Series Downlight is the ideal product for architectural energy efficient lighting in commercial and residential applications where adjustability is required. Available in an assortment of color temperatures, optics, lumen outputs, and dimmable driver options.

PRIME FEATURES

Color Temperature: 2700K, 3000K, 3500K, or 4000K
SDCM: 2 step binning
Color Rendering Index: 93+ CRI
Optical Lens: 18°, 30°, 50°, 80°
Trim: Die cast or anodized
LED Life: 50,000 Hours
LED Type: Cree LED
Driver Info: 120-277V, 50/60 Hz, PF>0.9, THD<0.20
Warranty: 5 year limited warranty

LED ENGINE

LED engine available with Cree LEDs in 2700K, 3000K, 3500K, or 4000K in standard 93+ CRI. 2 Step MacAdam ellipse allows for color consistency between fixtures. LED mounted to aluminum heat sink for maximum life output and thermal management. Light engine provides a quick disconnect with locking strain relief to housing.

FRAME CONSTRUCTION

Constructed from 16 gauge heavy duty powder coated cold rolled steel frame with a large access junction box.

ADJUSTMENT

- Light engine allows for hot aiming from 0-35°.
- Housing provides for 360° locking rotation.
- Aperture collar adjusts 15° ± horizontally within frame for square ceiling alignment.
- Collar notch allows for easy alignment for square applications.
- Aperture collar compatible up to 1 1/2" ceiling thickness.
- Accommodation for 2" or 3" ceiling thickness available upon request.

OPTICS

Field replaceable optical lens available in 18°, 30°, 50°, and 80°. Easily achieve narrow spot to wide flood beam pattern. Option for frosted, honeycomb, or solite filter (2 maximum).

DIMMING

Available in 8 driver selections. (ID) Standard all-inclusive ELV, Triac, and 0-10V dimming driver called Intelligent Drive, 120-277V. (PEQ0) Lutron Hi-Lume Premier Ecosystem 0.1% w/soft on, fade to black dimming, 120-277V. (LDE1) Lutron Hi-Lume 1% Ecosystem with soft on, fade to black dimming, 120-277V. (LTE) Lutron Hi-Lume 1% EcoSystem/3-Wire L3D Driver (EEL) eldoLED Eco 1% Dim (0-10V), 120-277V. (EDIO) eldoLED Solo 0.1% Dim(0-10V), 120-277V. (EDID) eldoLED Solo 0.1% Dim(DALI), 120-277V.

THERMAL MANAGEMENT

Ambient temperatures at fixture location should not exceed -20° to 40°C.

EMERGENCY BATTERY

Optional emergency battery available for a minimum of 90 minutes with both integral or remote test switch in 800 or 1700 delivered lumens.

TRIM OPTIONS

- All trims are self flanged die cast or anodized.
- Trim includes standard frosted acrylic diffuser.
- 12% lumens increase if remove standard frosted acrylic diffuser in field.
- Optical Enhancer reflects light evenly across the diffusion lens.
- Trims available in round or square in an assortment of standard or made to order finishes.

LABELS/COMPLIANCE/WARRANTY

- CSA Listed for US and Canada
- Energy Star
- Dry/Damp/Wet location rated.
- Title 24, JA8 Compliant
- 5 Year limited warranty



HOUSING ORDERING INFORMATION

RPA6						
Series	Lumens	Color Temp	Voltage	Dimming	Optical Lens ⁹	Filter
PRIME	10L ¹ - 1060 lm	27 - 2700K	UNV - 120-277V	ID ³ - Standard all-inclusive ELV, Triac, and 0-10V dimming driver (Intelligent Drive)	18 - 18°	None - Leave blank
SERIES	13L ¹ - 1320 lm	30 - 3000K	120 - 120V	PEQ0 ⁴ - Lutron Hi-Lume Premier Ecosystem 0.1% w/soft on, fade to black dimming LDE1 ⁶ - Lutron Hi-Lume 1% Ecosystem with soft on, fade to black dimming LTE ^{5,6} - Lutron Hi-Lume 1% 2-wire L3DA - Hi-lume 1% EcoSystem/3-Wire L3D Driver EEI ^{6,7,8} - eldoLED Eco 1% Dim (0-10V) EDIO ^{6,7,8} - eldoLED Solo 0.1% Dim (0-10V) EDID ^{6,7,8} - eldoLED Solo 0.1% Dim (DALI)	30 - 30°	F - Frosted filter
	16L ¹ - 1650 lm	35 - 3500K	347 ² - 347V		50 - 50°	H - Honeycomb
	21L ¹ - 2185 lm	40 - 4000K			80 - 80°	S - Solite filter
	25L ¹ - 2550 lm					
	31L ¹ - 3175 lm					
	35L ¹ - 3560 lm					
	41L ¹ - 4155 lm					

	RFA			
Housing Type	Aperture	Frame Accessories	Collar	Option
NC - Non-IC New Construction IC ¹⁰ - IC Air-tight New Construction	RFA - Round Flanged Adjustable	C - C Channel bar hanger B - Flat bar hanger WJ - Wood Joist	Blank - 1.5" Depth 20 - 2" Depth 30 - 3" Depth MTO - Made to order	E18 - Emergency battery with integral switch(800 Lumens) ER8 - Emergency battery with remote switch (800 Lumens) E117 - Emergency battery with integral switch(1700 Lumens) ER17 - Emergency battery with remote switch (1700 Lumens) FCJS-E - Vive wireless individual controller(Ecosystem) FCJS-O - Vive wireless individual controller(0-10) CP ¹⁸ - Chicago Plenum

TRIM ORDERING INFORMATION

Aperture Size / Shape / Trim Type / Style	Bevel / Flange Finish	Options
6RFO - 6" Round Flange Open 6RFA - 6" Round Flange Accent	W-W - White bevel / white flange H-W - Haze bevel / white flange B-B - Black bevel / black flange H-H - Haze bevel / Haze flange S-S - Specular clear bevel / Specular clear flange S-W - Specular clear bevel / white flange WE-WE - Wheat bevel / wheat flange MTO - Made to order	WL - Wet location

1. Compatible with IC new construction housing.
2. Step down transformer required.
3. Intelligent Drive is the standard driver.
4. Driver must not exceed 1650 lm
5. 120V only.
6. Inapplicable to 4155 Lumen offering.
7. Must specify logarithmic or linear eldoLED driver.
8. Confirm dimming curve: linear or logarithmic.
9. Without standard frosted acrylic diffuser.
10. Compatible up to 2185 lumens.

PRIME

PRIME 6" LED ARCHITECTURAL ROUND FLANGED
OPEN/ACCENT TRIM ADJUSTABLE

JOB INFORMATION	TYPE:
	CATALOG NO.:
	PROJECT NAME:
	COMMENTS:
	PREPARED BY:

6" PRIME ADJUSTABLE

LUMEN CHART

Wattage	Delivered Lumens	Voltage	CRI
11W	1060 Lm	120-277V	93+
16W	1320 Lm	120-277V	93+
20W	1650 Lm	120-277V	93+
30W	2185 Lm	120-277V	93+
31W	2550 Lm	120-277V	93+
38W	3175 Lm	120-277V	93+
45W	3560 Lm	120-277V	93+
58W	4155 Lm	120-277V	93+

*Above chart, ordering information, and IES File name reflect delivered lumens based 3000K and 30° optical lens.
**Lumens will vary based on CCT, optical lens, and bevel finish.

DIMENSION

Trim Details

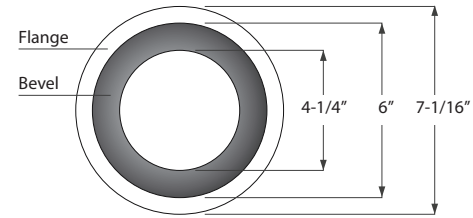
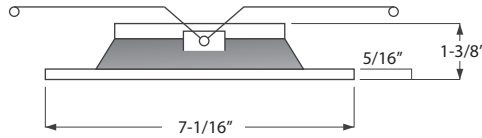

1 PIECE DIE CAST

Trim Details

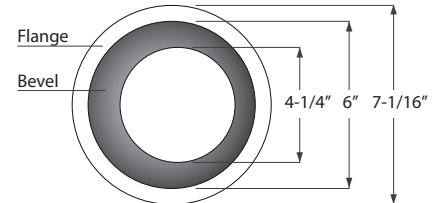
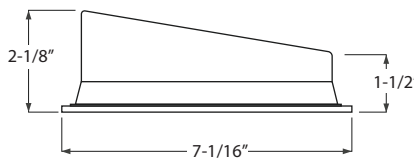

1 PIECE DIE CAST

LED HOLDER & FILTER DIMENSION

LED Holder and Filter



Filter

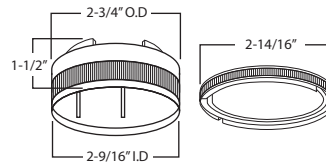

LED Holder

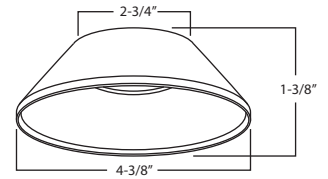

Light Enhancer

PRIME

PRIME 6" LED ARCHITECTURAL ROUND FLANGED
OPEN/ACCENT TRIM ADJUSTABLE

JOB INFORMATION	TYPE:
	CATALOG NO.:
	PROJECT NAME:
	COMMENTS:
	PREPARED BY:

6" PRIME ADJUSTABLE

HOUSING DIMENSION

IC Housing Details

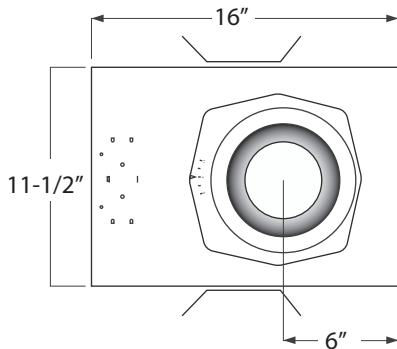
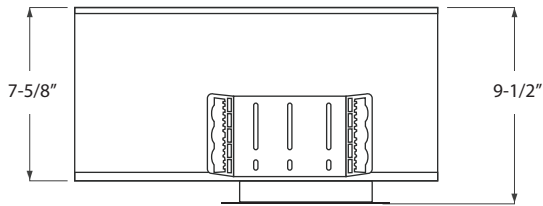

Non-IC Housing Details

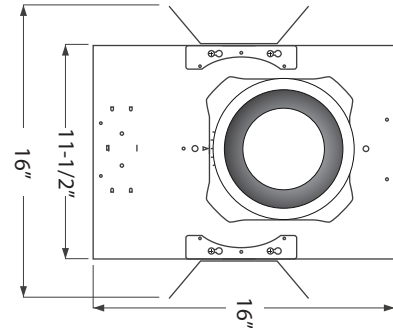
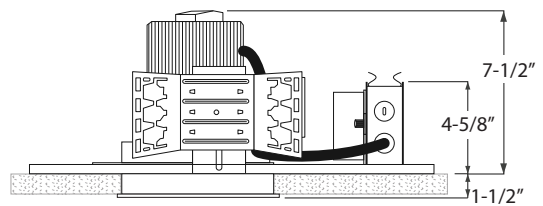

Ceiling Cut-out: 6-3/8"
Maximum Ceiling Thickness: 1-1/2"
Minimum Ceiling Thickness: 1/2"
Consult factory for custom ceiling thickness

COLLAR DEPTH PER CEILING THICKNESS

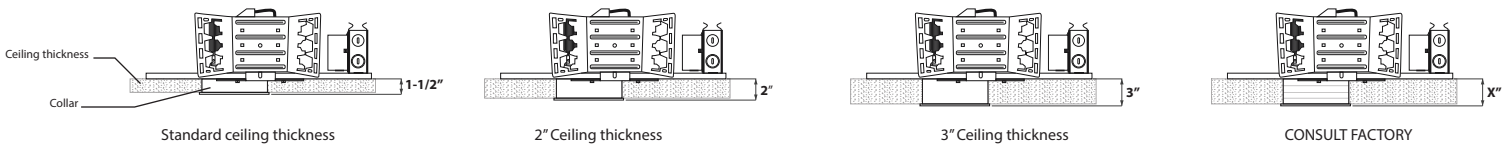

PRIME

PRIME 6" LED ARCHITECTURAL ROUND FLANGED
OPEN/ACCENT TRIM ADJUSTABLE

FRAME ACCESSORIES

WJ

Slotted Holes allow for an easier installation

Wood Joist

4" up to 8" CKOs

Fits up to 26" stud spacings

Plate is offset, allowing for adjustability with irregular stud spacing

B

27"

1/2"

Flat Bar Hanger

C

25-3/16"

1-6/16"

C Channel Bar Hanger

PRIME

PRIME 6" LED ARCHITECTURAL
ROUND FLANGED ADJUSTABLE

6" PRIME ADJUSTABLE

AT-A-GLANCE TECHNICAL INFORMATION

RPA - 10L 18° BEAM		RPA - 10L 30° BEAM		RPA - 10L 60° BEAM		RPA - 10L 80° BEAM	
TEST DATE	2020-07-27	TEST DATE	2020-07-27	TEST DATE	2020-07-27	TEST DATE	2020-07-27
SERIES	RPA6-10L-30K-18°-RFD	SERIES	RPA6-10L-30K-30°-RFD	SERIES	RPA6-10L-30K-60°-RFD	SERIES	RPA6-10L-30K-80°-RFD
LUMENS	995 LM	LUMENS	1060.7 LM	LUMENS	1004.9 LM	LUMENS	948.8 LM
WATTS	11.92 W	WATTS	11.91 W	WATTS	11.92 W	WATTS	11.86 W
CCT	3000K	CCT	3000K	CCT	3000K	CCT	3000K

RPA - 13L 18° BEAM		RPA - 13L 30° BEAM		RPA - 13L 60° BEAM		RPA - 13L 80° BEAM	
TEST DATE	2020-07-27	TEST DATE	2020-07-27	TEST DATE	2020-07-27	TEST DATE	2020-07-27
SERIES	RPA6-13L-30K-18°-RFD	SERIES	RPA6-13L-30K-30°-RFD	SERIES	RPA6-13L-30K-60°-RFD	SERIES	RPA6-13L-30K-80°-RFD
LUMENS	1239.9 LM	LUMENS	1319.9 LM	LUMENS	1182.9 LM	LUMENS	1098.8 LM
WATTS	16.01 W	WATTS	16.01 W	WATTS	16.02 W	WATTS	16.01 W
CCT	3000K	CCT	3000K	CCT	3000K	CCT	3000K

[CLICK HERE OR VISIT PRODUCT PAGE FOR COMPREHENSIVE TECHNICAL INFORMATION](#)

PRIME

PRIME 6" LED ARCHITECTURAL
ROUND FLANGED ADJUSTABLE

6" PRIME ADJUSTABLE

AT-A-GLANCE TECHNICAL INFORMATION

RPA - 16L 18° BEAM

TEST DATE 2020-07-27
SERIES RPA6-16L-30K-18°-RFD
LUMENS 1547.9 LM
WATTS 20.34 W
CCT 3000K

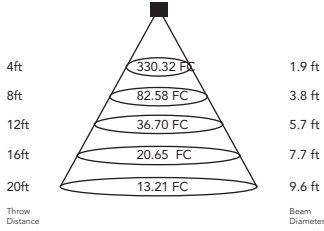

Zone	Lumens	%Lamp	%Luminaire
0-30	1,267.1	81.9%	81.8%
0-40	1,408.3	91%	90.9%
0-60	1,522.7	98.4%	98.3%
60-90	26.2	1.7%	1.7%
0-90	1,548.8	100.1%	1.6%

Zone Lumen Summary

RPA - 16L 30° BEAM

TEST DATE 2020-07-27
SERIES RPA6-16L-30K-30°-RFD
LUMENS 1650.8 LM
WATTS 20.33 W
CCT 3000K

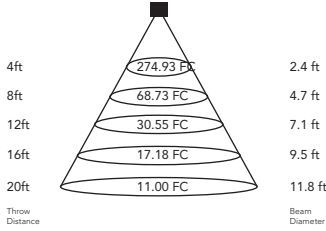

Zone	Lumens	%Lamp	%Luminaire
0-30	1,420.0	86%	86%
0-40	1,565.0	94.8%	94.8%
0-60	1,1634.4	99%	99%
60-90	16.5	1%	1%
0-90	1,650.9	100%	100%

Zone Lumen Summary

RPA - 16L 60° BEAM

TEST DATE 2020-07-27
SERIES RPA6-16L-30K-60°-RFD
LUMENS 1564.5 LM
WATTS 20.33 W
CCT 3000K

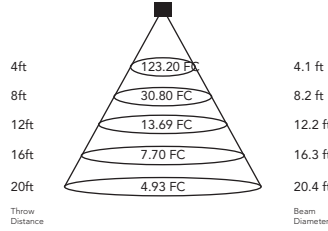

Zone	Lumens	%Lamp	%Luminaire
0-30	1,164.8	74.5%	74.5%
0-40	1,426.5	91.2%	91.2%
0-60	1,537.9	98.3%	98.3%
60-90	25.9	1.7%	1.7%
0-90	1,563.8	100%	100%

Zone Lumen Summary

RPA - 16L 80° BEAM

TEST DATE 2020-07-27
SERIES RPA6-16L-30K-80°-RFD
LUMENS 1468.5 LM
WATTS 20.34 W
CCT 3000K

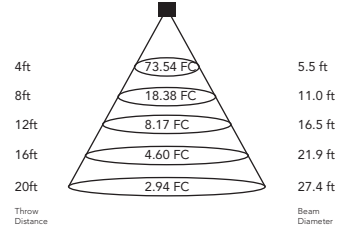

Zone	Lumens	%Lamp	%Luminaire
0-30	879.0	59.9%	59.9%
0-40	1,236.2	84.2%	84.2%
0-60	1,421.5	96.9%	96.9%
60-90	45.9	3.1%	3.1%
0-90	1,467.4	99.9%	100%

Zone Lumen Summary

RPA - 21L 18° BEAM

TEST DATE 2020-07-27
SERIES RPA6-21L-30K-18°-RFD
LUMENS 2048.6 LM
WATTS 29.9 W
CCT 3000K

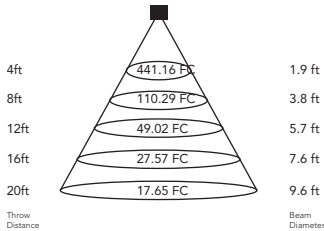

Zone	Lumens	%Lamp	%Luminaire
0-30	1,685.5	82.3%	82.2%
0-40	1,866.7	91.1%	91.1%
0-60	2,015.3	98.4%	98.3%
60-90	34.3	1.7%	1.7%
0-90	2,049.6	100.1%	100%

Zone Lumen Summary

RPA - 21L 30° BEAM

TEST DATE 2020-07-27
SERIES RPA6-21L-30K-30°-RFD
LUMENS 2184.2 LM
WATTS 29.82 W
CCT 3000K

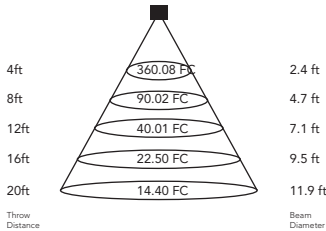

Zone	Lumens	%Lamp	%Luminaire
0-30	1,878.5	86%	86%
0-40	2,070.7	94.8%	94.8%
0-60	2,161.7	99%	99%
60-90	21.9	1%	1%
0-90	2,183.6	100%	100%

Zone Lumen Summary

RPA - 21L 60° BEAM

TEST DATE 2020-07-27
SERIES RPA6-21L-30K-60°-RFD
LUMENS 2061.2 LM
WATTS 29.82 W
CCT 3000K

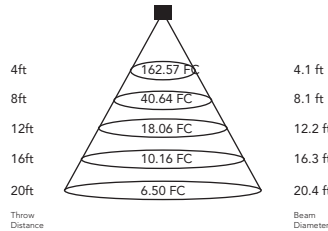

Zone	Lumens	%Lamp	%Luminaire
0-30	1,536.5	74.5%	74.6%
0-40	1,879.4	91.2%	91.2%
0-60	2,026.0	98.3%	98.3%
60-90	34.5	1.7%	1.7%
0-90	2,060.5	100%	100%

Zone Lumen Summary

RPA - 21L 80° BEAM

TEST DATE 2020-07-27
SERIES RPA6-21L-30K-80°-RFD
LUMENS 1950.8 LM
WATTS 29.84 W
CCT 3000K

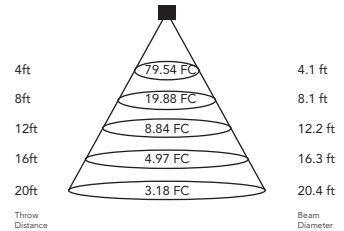

Zone	Lumens	%Lamp	%Luminaire
0-30	1,165.2	59.7%	59.8%
0-40	1,641.2	84.1%	84.2%
0-60	1,887.9	96.8%	96.8%
60-90	61.4	3.1%	3.2%
0-90	1,949.3	99.9%	100%

Zone Lumen Summary

[CLICK HERE OR VISIT PRODUCT PAGE FOR COMPREHENSIVE TECHNICAL INFORMATION](#)

PRIME

PRIME 6" LED ARCHITECTURAL
ROUND FLANGED ADJUSTABLE

6" PRIME ADJUSTABLE

AT-A-GLANCE TECHNICAL INFORMATION

RPA - 25L 18° BEAM

TEST DATE 2020-07-27
SERIES RPA6-25L-30K-18°-RFD
LUMENS 2401.1 LM
WATTS 28.46 W
CCT 3000K

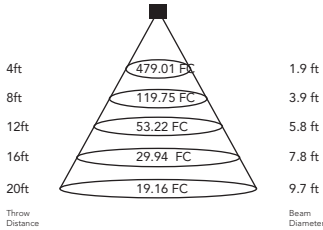

Zone	Lumens	%Lamp	%Luminaire
0-30	1,941.9	80.9%	80.8%
0-40	2,181.7	90.9%	90.8%
0-60	2,361.3	98.3%	98.3%
60-90	41.3	1.7%	1.7%
0-90	2,402.7	100.1%	1.6%

Zone Lumen Summary

RPA - 25L 30° BEAM

TEST DATE 2020-07-27
SERIES RPA6-25L-30K-30°-RFD
LUMENS 2551.8 LM
WATTS 28.41 W
CCT 3000K

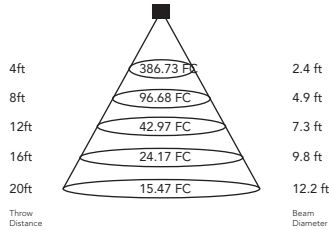

Zone	Lumens	%Lamp	%Luminaire
0-30	2,123.7	83.2%	83.2%
0-40	2,401.1	94.1%	94.1%
0-60	2,523.0	98.9%	98.9%
60-90	28.7	1.1%	1.1%
0-90	2,551.6	100%	100%

Zone Lumen Summary

RPA - 25L 60° BEAM

TEST DATE 2020-07-27
SERIES RPA6-25L-30K-60°-RFD
LUMENS 2421.8 LM
WATTS 28.44 W
CCT 3000K

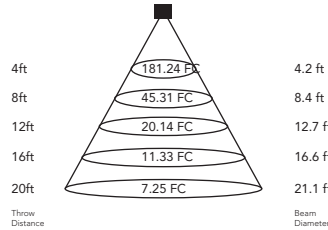

Zone	Lumens	%Lamp	%Luminaire
0-30	1,760.3	72.7%	72.7%
0-40	2,194.5	90.6%	90.7%
0-60	2,378.3	98.2%	98.2%
60-90	42.4	1.8%	1.8%
0-90	2,420.8	100%	100%

Zone Lumen Summary

RPA - 25L 80° BEAM

TEST DATE 2020-07-27
SERIES RPA6-25L-30K-80°-RFD
LUMENS 2275.6 LM
WATTS 28.43 W
CCT 3000K

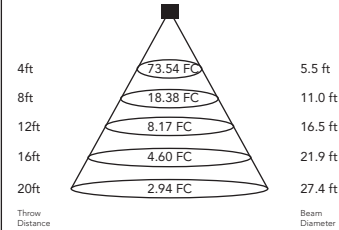

Zone	Lumens	%Lamp	%Luminaire
0-30	1,360.5	59.8%	59.8%
0-40	1,913.9	84.1%	84.2%
0-60	2,202.7	96.8%	96.9%
60-90	71.3	3.1%	3.1%
0-90	2,274.0	99.9%	100%

Zone Lumen Summary

RPA - 31L 18° BEAM

TEST DATE 2020-07-27
SERIES RPA6-31L-30K-18°-RFD
LUMENS 3004.6 LM
WATTS 37.68 W
CCT 3000K

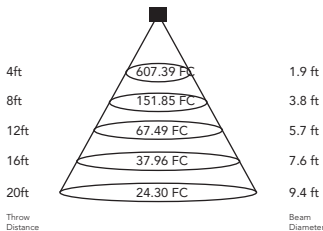

Zone	Lumens	%Lamp	%Luminaire
0-30	2,428.9	80.8%	80.8%
0-40	2,728.4	90.8%	90.8%
0-60	2,953.7	98.3%	98.3%
60-90	52.2	1.7%	1.7%
0-90	3,005.9	100.1%	100%

Zone Lumen Summary

RPA - 31L 30° BEAM

TEST DATE 2020-07-27
SERIES RPA6-31L-30K-30°-RFD
LUMENS 3177.1 LM
WATTS 37.61 W
CCT 3000K

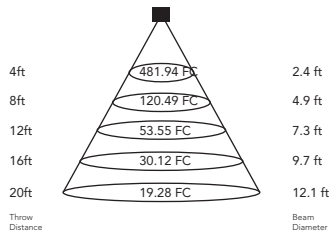

Zone	Lumens	%Lamp	%Luminaire
0-30	2,644.9	83.2%	83.3%
0-40	2,989.6	94.1%	94.1%
0-60	3,141.1	98.9%	98.9%
60-90	36.0	1.1%	1.1%
0-90	3,177.1	100%	100%

Zone Lumen Summary

RPA - 31L 60° BEAM

TEST DATE 2020-07-27
SERIES RPA6-31L-30K-60°-RFD
LUMENS 2992.6 LM
WATTS 37.71 W
CCT 3000K

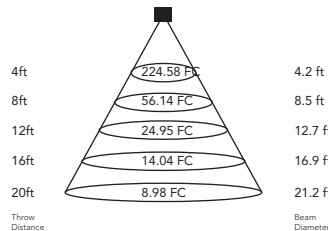

Zone	Lumens	%Lamp	%Luminaire
0-30	2,179.3	72.8%	72.8%
0-40	2,714.0	90.7%	90.7%
0-60	2,939.5	98.2%	98.2%
60-90	52.8	1.8%	1.8%
0-90	2,992.2	100%	100%

Zone Lumen Summary

RPA - 31L 80° BEAM

TEST DATE 2020-07-27
SERIES RPA6-31L-30K-80°-RFD
LUMENS 2824.7 LM
WATTS 37.55 W
CCT 3000K

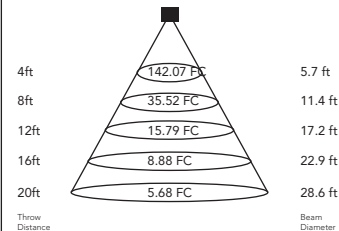

Zone	Lumens	%Lamp	%Luminaire
0-30	1,689.8	59.8%	59.9%
0-40	2,375.9	84.1%	84.2%
0-60	2,734.1	96.8%	96.9%
60-90	88.9	3.1%	3.1%
0-90	2,823.0	99.9%	100%

Zone Lumen Summary

[CLICK HERE OR VISIT PRODUCT PAGE FOR COMPREHENSIVE TECHNICAL INFORMATION](#)

PRIME

PRIME 6" LED ARCHITECTURAL
ROUND FLANGED ADJUSTABLE

6" PRIME ADJUSTABLE

AT-A-GLANCE TECHNICAL INFORMATION

RPA - 35L 18° BEAM

TEST DATE 2020-07-27
SERIES RPA6-35L-30K-18°-RFD
LUMENS 3358.4 LM
WATTS 44.67 W
CCT 3000K

Zone	Lumens	%Lamp	%Luminaire
0-30	2,714.4	80.8%	80.8%
0-40	3,049.1	90.8%	90.7%
0-60	3,302.3	98.3%	98.3%
60-90	58.6	1.7%	1.7%
0-90	3,360.9	100.1%	100%

Zone Lumen Summary

RPA - 35L 30° BEAM

TEST DATE 2020-07-27
SERIES RPA6-35L-30K-30°-RFD
LUMENS 3562.5 LM
WATTS 44.66 W
CCT 3000K

Zone	Lumens	%Lamp	%Luminaire
0-30	2,963.1	83.2%	83.2%
0-40	3,351.2	94.1%	94.1%
0-60	3,521.9	98.9%	98.9%
60-90	40.6	1.1%	1.1%
0-90	3,562.6	100%	100%

Zone Lumen Summary

RPA - 35L 60° BEAM

TEST DATE 2020-07-27
SERIES RPA6-35L-30K-60°-RFD
LUMENS 3366.3 LM
WATTS 44.56 W
CCT 3000K

Zone	Lumens	%Lamp	%Luminaire
0-30	2,449.7	72.8%	72.8%
0-40	3,051.9	90.7%	90.7%
0-60	3,305.7	98.2%	98.2%
60-90	59.6	1.8%	1.8%
0-90	3,365.3	100%	100%

Zone Lumen Summary

RPA - 35L 80° BEAM

TEST DATE 2020-07-27
SERIES RPA6-35L-30K-80°-RFD
LUMENS 3182.7 LM
WATTS 44.36 W
CCT 3000K

Zone	Lumens	%Lamp	%Luminaire
0-30	1,904.2	59.8%	59.9%
0-40	2,677.2	84.1%	84.2%
0-60	3,080.5	96.8%	96.8%
60-90	100.3	3.2%	3.2%
0-90	3,180.8	99.9%	100%

Zone Lumen Summary

RPA - 41L 18° BEAM

TEST DATE 2020-07-27
SERIES RPA6-41L-30K-18°-RFD
LUMENS 3995.3 LM
WATTS 57.69 W
CCT 3000K

Zone	Lumens	%Lamp	%Luminaire
0-30	2,998.3	75%	75.1%
0-40	3,553.9	89%	89%
0-60	3,911.9	97.9%	97.9%
60-90	83.0	2.1%	2.1%
0-90	3,994.8	100%	100%

Zone Lumen Summary

RPA - 41L 30° BEAM

TEST DATE 2020-07-27
SERIES RPA6-41L-30K-30°-RFD
LUMENS 4157.8 LM
WATTS 57.64 W
CCT 3000K

Zone	Lumens	%Lamp	%Luminaire
0-30	3,184.3	76.6%	76.7%
0-40	3,800.8	91.4%	91.5%
0-60	4,087.2	98.3%	98.4%
60-90	66.9	1.6%	1.6%
0-90	4,154.1	99.9%	100%

Zone Lumen Summary

RPA - 41L 60° BEAM

TEST DATE 2020-07-27
SERIES RPA6-41L-30K-60°-RFD
LUMENS 3914.6 LM
WATTS 57.66 W
CCT 3000K

Zone	Lumens	%Lamp	%Luminaire
0-30	2,696.9	68.9%	68.9%
0-40	3,467.2	88.6%	88.6%
0-60	3,829.6	97.8%	97.9%
60-90	83.7	2.1%	2.1%
0-90	3,913.3	100%	100%

Zone Lumen Summary

RPA - 41L 80° BEAM

TEST DATE 2020-07-27
SERIES RPA6-41L-30K-80°-RFD
LUMENS 3753.7 LM
WATTS 57.71 W
CCT 3000K

Zone	Lumens	%Lamp	%Luminaire
0-30	2,262.7	60.3%	60.3%
0-40	3,152.5	84%	84.1%
0-60	3,631.0	96.7%	96.8%
60-90	119.3	3.2%	3.2%
0-90	3,750.3	99.9%	100%

Zone Lumen Summary

[CLICK HERE OR VISIT PRODUCT PAGE FOR COMPREHENSIVE TECHNICAL INFORMATION](#)