

PRIME

PRIME 3" SHALLOW LED ARCHITECTURAL ROUND FLANGED DOWNLIGHT

JOB INFORMATION	TYPE:
	CATALOG NO.
	PROJECT NAME:
	COMMENTS:
	PREPARED BY:

USE OF PRODUCT

The 3" PRIME Downlight is a small aperture fixture with shallow height that may be used in residential and commercial applications. Available with die cast or spun aluminum trims, with an assortment of color temperatures, optics and dimmable drivers.

PRIME FEATURES

Color Temperature: 2700K, 3000K, 3500K, or 4000K
 SDCM: 2 step binning
 Color Rendering Index: 93+ CRI
 Optical Lens: 12°, 22°, 27°, 35°, 45°
 Trim: Die cast or spun aluminum
 LED Life: 50,000 Hours
 LED Type: Cree LED
 Driver Info: 120-277V, 50/60 Hz, PF>0.9, THD<0.20
 Warranty: 5 year limited warranty

LED ENGINE

LED engine available with CREE LEDs in 2700K, 3000K, 3500K, or 4000K in standard 93+ CRI. 2 Step MacAdam ellipse allows for color consistency between fixtures. LED mounted to aluminum heat sink for maximum life output and thermal management. LED engine is accessible from below ceiling.

FRAME CONSTRUCTION

IC Air-tight rated housing constructed from 16 gauge heavy duty powder coated cold rolled steel frame. Junction box with 1/2" knockouts. Butterfly bracket included to accommodate adjustable bar hangers or C-channel (ordered separately).

ADJUSTMENT

- Housing provides for 359° locking rotation
 - Aperture collar compatible up to 1½" ceiling thickness.
 - Accommodation for 2" or 3" ceiling thickness available upon request.

OPTICAL LENS & FILTERS (Field Replaceable)

Field replaceable optical lens available in 12°, 22°, 27°, 35° and 45°. Easily achieve narrow spot to wide flood beam pattern. Accepts up to 2 filters.

DIMMING

Available in 8 driver selections. (ID) Standard all-inclusive ELV(120V), Triac(120V), and 0-10V(120-277V) dimming driver called Intelligent Drive, 120-277V. (PEQ0) Lutron Hi-Lume Premier Ecosystem 0.1% w/soft on, fade to black dimming, 120-277V. (LDE1) Lutron Hi-Lume 1% Ecosystem with soft on, fade to black dimming, 120-277V. (L3DA) Hi-lume 1% EcoSystem/3-Wire L3D Driver (EEI) eldoLED Eco 1% Dim (0-10V), 120-277V. (EDIO) eldoLED Solo 0.1% Dim(0-10V), 120-277V. (EDID) eldoLED Solo 0.1% Dim(DALI), 120-277V. Driver accessible from below ceiling.

THERMAL MANAGEMENT

Ambient temperatures at fixture location should not exceed -20° to 40°C.

TRIM

Trim available in die cast or spun aluminum. Consult factory for made to order finishes. Flanged trim is compatible with all ceiling materials.

EMERGENCY BATTERY

Optional emergency battery available for a minimum of 90 minutes with Remote test switch in 800 delivered lumens.

LABELS/COMPLIANCE/WARRANTY

- CSA Listed for US and Canada
 - Energy Star
 - Dry/Damp/Wet location rated.
 - Title 24, JA8 Compliant
 - 5 Year limited warranty.



ORDERING INFO

Series	Lumens	Color Temp	Voltage	Dimming	Optical Lens	Filter
PRIME SERIES	8 - 890 lm 11 - 1175 lm 16 - 1650 lm	27 - 2700K 30 - 3000K 35 - 3500K 40 - 4000K	UNV - 120-277V 120 - 120V 347 - 347V	ID ¹ - Standard all-inclusive ELV, Triac, and 0-10V dimming driver (Intelligent Drive) PEQ0 - Lutron Hi-lume Premier Ecosystem 0.1% w/soft on, fade to black dimming LDE1 ¹ - Lutron Hi-Lume 1% Ecosystem with soft on, fade to black dimming LTE ² - Hi-Lume 1% 2-wire L3DA - Hi-Lume 1% EcoSystem/3-Wire L3D Driver EEI ¹ - eldoLED Eco 1% Dim (0-10V) EDIO ^{2,3} - eldoLED Solo 0.1% Dim (0-10V) EDID ³ - eldoLED Solo 0.1% Dim (DALI)	12 - 12° 22 - 22° 27 - 27° 35 - 35° 45 - 45°	None - Leave blank F - Frosted H - Honeycomb S - Solite L - Linear

Housing Type	Aperture	Frame Accessories	Collar	Option
IC - IC Air-tight Shallow New Construction	RFD - Round Flanged Downlight	AH - Adjustable bar hanger C - C Channel bar hanger B - Flat bar hanger	Blank - 1.5" Depth 20 - 2" Depth 30 - 3" Depth MTO - Made to order	ERB ³ - Emergency battery with remote switch (800 Lumens) CP - Chicago Plenum

1. Intelligent Drive is the standard driver.
 2. Ceiling access required.
 3. Must specify logarithmic or linear eldoLED driver.

TRIM ORDERING INFORMATION

Aperture Size / Shape / Trim Type / Style	Bevel Opening	Bevel	Flange	Options
3RFO - 3" Round Flange Open	Die Cast	W - White B - Black H - Haze BZ - Bronze C - Clear MTO - Made to order	W - White B - Black BZ - Bronze MTO - Made to order	WL - Wet location
	Spun Aluminum (Self Flanged)	H - Haze C - Clear MTO - Made to order		WL - Wet location

PRIME

PRIME 3" SHALLOW LED ARCHITECTURAL ROUND FLANGED DOWNLIGHT

DIMENSIONS

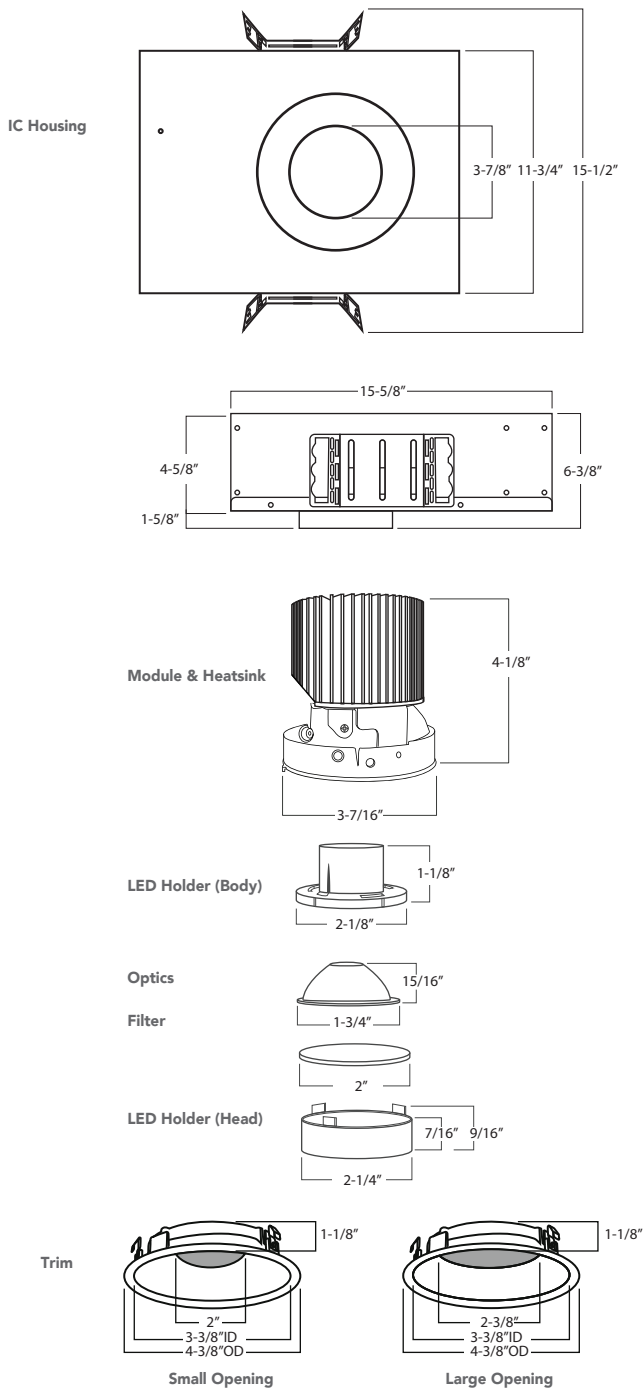

TRIM THICKNESS

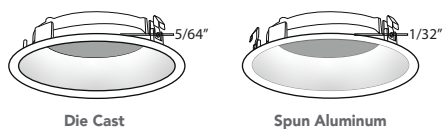

LUMEN CHART

Wattage	Delivered Lumens	Voltage	CRI
10W	890 Lm	120-277V	93+
14W	1175 Lm	120-277V	93+
20W	1650 Lm	120-277V	93+

*Above chart and ordering information reflect delivered lumens based on 3000K, 35° optical lens, with white bevel.
 **Lumens will vary based on CCT, optical lens, and bevel finish

FRAME ACCESSORIES

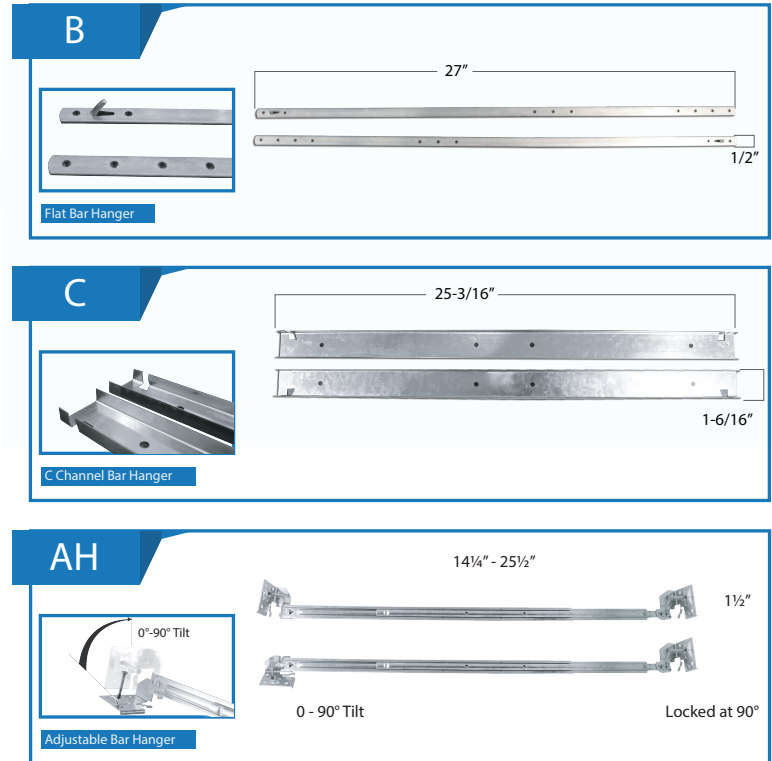

COLLAR DEPTH PER CEILING THICKNESS

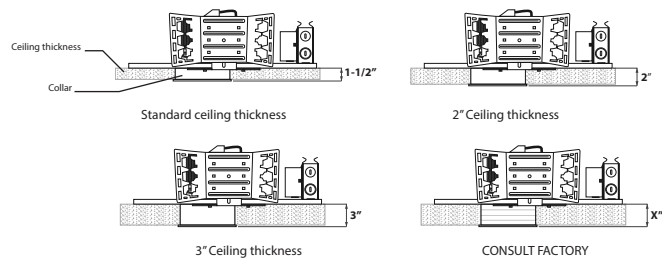

PRIME

PRIME 3" LED ARCHITECTURAL
ROUND FLANGED DOWNLIGHT

3" PRIME DOWNLIGHT

AT-A-GLANCE TECHNICAL INFORMATION

RPA - 8L

12° Beam, Round Large Open

TEST DATE	2019-07-12
SERIES	RPA3-8L-30K-12°- Round Large Open
LUMENS	853.9 LM
WATTS	10 W
CCT	3000K

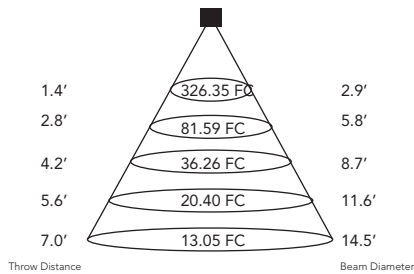

Zone	Lumens	%Lamp	%Luminaire
0-30	770.6	90.2%	90.1%
0-40	813.0	95.2%	95.1%
0-60	849.0	99.4%	99.3%
60-90	6.2	0.7%	0.7%
0-90	855.2	100.2%	100%

Zone Lumen Summary

RPA - 8L

22° Beam, Round Large Open

TEST DATE	2019-07-12
SERIES	RPA3-8L-30K-22°- Round Large Open
LUMENS	843.5 LM
WATTS	10 W
CCT	3000K

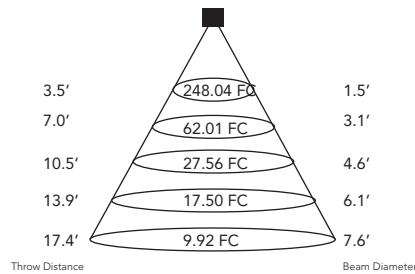

Zone	Lumens	%Lamp	%Luminaire
0-30	748.9	88.8%	88.7%
0-40	804.5	95.4%	95.3%
0-60	838.3	99.4%	99.3%
60-90	5.9	0.7%	0.7%
0-90	844.2	100.1%	100%

Zone Lumen Summary

RPA - 8L

27° Beam, Round Large Open

TEST DATE	2019-07-12
SERIES	RPA3-8L-30K-27°- Round Large Open
LUMENS	862.4 LM
WATTS	10 W
CCT	3000K

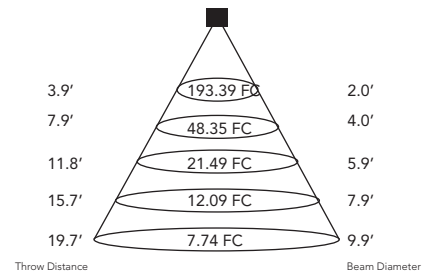

Zone	Lumens	%Lamp	%Luminaire
0-30	775.4	89.9%	89.9%
0-40	828.3	96.1%	96%
0-60	858.2	99.5%	99.5%
60-90	4.7	0.5%	0.5%
0-90	862.9	100.1%	100%

Zone Lumen Summary

RPA - 8L

35° Beam, Round Large Open

TEST DATE	2019-07-12
SERIES	RPA3-8L-30K-35°- Round Large Open
LUMENS	889.5 LM
WATTS	10 W
CCT	3000K

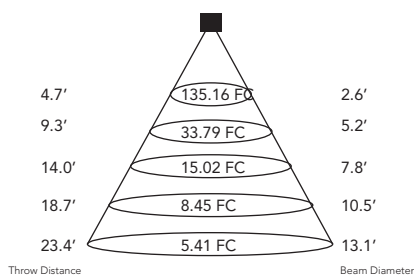

Zone	Lumens	%Lamp	%Luminaire
0-30	774.3	87%	87%
0-40	848.5	95.4%	95.4%
0-60	884.8	99.5%	99.5%
60-90	4.8	0.5%	0.5%
0-90	889.5	100%	100%

Zone Lumen Summary

RPA - 8L

45° Beam, Round Large Open

TEST DATE	2019-07-12
SERIES	RPA3-8L-30K-45°- Round Large Open
LUMENS	861 LM
WATTS	10 W
CCT	3000K

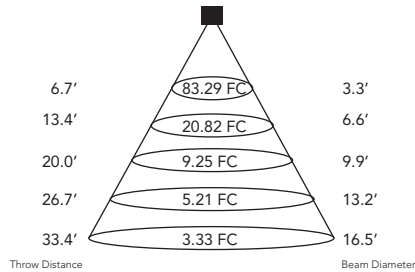

Zone	Lumens	%Lamp	%Luminaire
0-30	625.2	72.6%	72.6%
0-40	778.1	90.4%	90.4%
0-60	854.3	99.2%	99.3%
60-90	6.4	0.7%	0.7%
0-90	860.7	100%	100%

Zone Lumen Summary

[CLICK HERE OR VISIT PRODUCT PAGE FOR COMPREHENSIVE TECHNICAL INFORMATION](#)

PRIME

PRIME 3" LED ARCHITECTURAL
ROUND FLANGED DOWNLIGHT

AT-A-GLANCE TECHNICAL INFORMATION

3" PRIME DOWNLIGHT

RPA - 11L

12° Beam, Round Large Open

TEST DATE	2019-07-12
SERIES	RPA3-11L-30K-12°- Round Large Open
LUMENS	1148.1 LM
WATTS	14 W
CCT	3000K

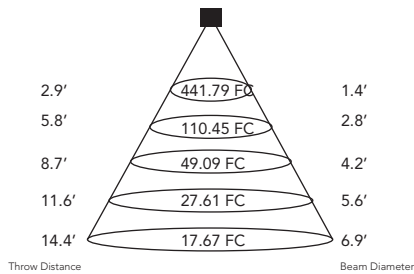

Zone	Lumens	%Lamp	%Luminaire
0-30	1,035.1	90.2%	90.1%
0-40	1,092.5	95.2%	95.1%
0-60	1,141.1	99.4%	99.3%
60-90	8.7	0.7%	0.7%
0-90	1,149.8	100.2%	100%

Zone Lumen Summary

RPA - 11L

22° Beam, Round Large Open

TEST DATE	2019-07-12
SERIES	RPA3-11L-30K-22°- Round Large Open
LUMENS	1146.7 LM
WATTS	14 W
CCT	3000K

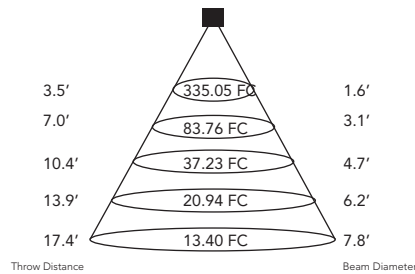

Zone	Lumens	%Lamp	%Luminaire
0-30	1,018.2	88.8%	88.7%
0-40	1,093.4	95.4%	95.2%
0-60	1,139.6	99.4%	99.3%
60-90	8.4	0.7%	0.7%
0-90	1,148.0	100.1%	100%

Zone Lumen Summary

RPA - 11L

27° Beam, Round Large Open

TEST DATE	2019-07-12
SERIES	RPA3-11L-30K-27°- Round Large Open
LUMENS	1177.4 LM
WATTS	14 W
CCT	3000K

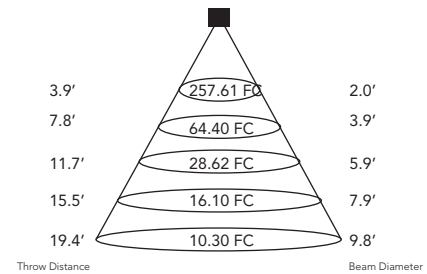

Zone	Lumens	%Lamp	%Luminaire
0-30	1,048.7	89.1%	89.1%
0-40	1,126.2	95.7%	95.6%
0-60	1,170.0	99.4%	99.4%
60-90	7.4	0.6%	0.6%
0-90	1,177.5	100%	100%

Zone Lumen Summary

RPA - 11L

35° Beam, Round Large Open

TEST DATE	2019-07-12
SERIES	RPA3-11L-30K-35°- Round Large Open
LUMENS	1203.8 LM
WATTS	14 W
CCT	3000K

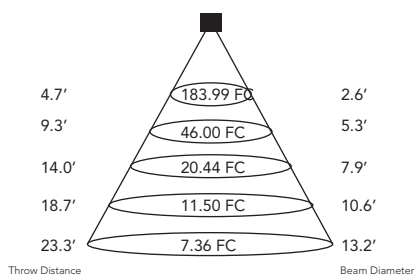

Zone	Lumens	%Lamp	%Luminaire
0-30	774.3	87%	87%
0-40	848.5	95.4%	95.4%
0-60	884.8	99.5%	99.5%
60-90	4.8	0.5%	0.5%
0-90	889.5	100%	100%

Zone Lumen Summary

RPA - 11L

45° Beam, Round Large Open

TEST DATE	2019-07-12
SERIES	RPA3-11L-30K-45°- Round Large Open
LUMENS	1165.8 LM
WATTS	14 W
CCT	3000K

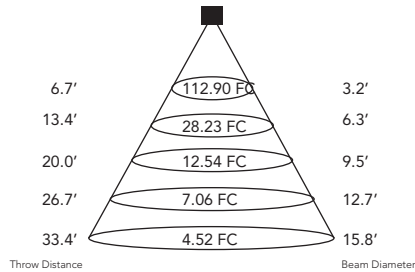

Zone	Lumens	%Lamp	%Luminaire
0-30	846.1	72.6%	72.6%
0-40	1,053.3	90.4%	90.4%
0-60	1,156.9	99.2%	99.2%
60-90	8.9	0.8%	0.8%
0-90	1,165.8	100%	100%

Zone Lumen Summary

[CLICK HERE OR VISIT PRODUCT PAGE FOR COMPREHENSIVE TECHNICAL INFORMATION](#)

PRIME

PRIME 3" LED ARCHITECTURAL
ROUND FLANGED DOWNLIGHT

AT-A-GLANCE TECHNICAL INFORMATION

3" PRIME DOWNLIGHT

RPA - 16L

12° Beam, Round Large Open

TEST DATE	2019-07-12
SERIES	RPA3-16L-30K-12°- Round Large Open
LUMENS	1560 LM
WATTS	20 W
CCT	3000K

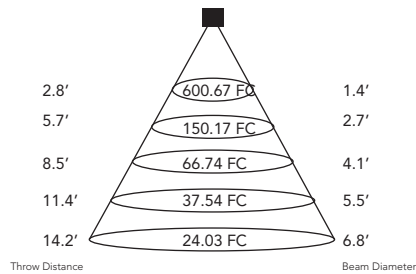

Zone	Lumens	%Lamp	%Luminaire
0-30	1,404.7	90%	89.9%
0-40	1,483.0	95.1%	94.9%
0-60	1,550.3	99.4%	99.2%
60-90	12.5	0.8%	0.8%
0-90	1,562.8	100.2%	100%

Zone Lumen Summary

RPA - 16L

22° Beam, Round Large Open

TEST DATE	2019-07-12
SERIES	RPA3-16L-30K-22°- Round Large Open
LUMENS	1541.5 LM
WATTS	20 W
CCT	3000K

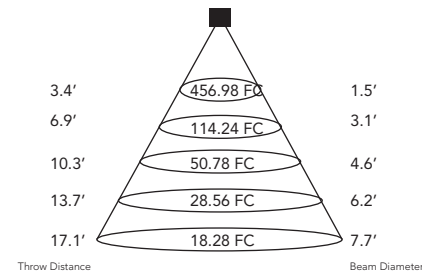

Zone	Lumens	%Lamp	%Luminaire
0-30	1,368.4	88.8%	88.7%
0-40	1,468.7	95.3%	95.2%
0-60	1,531.6	99.4%	99.3%
60-90	11.9	0.8%	0.8%
0-90	1,543.5	100.1%	100%

Zone Lumen Summary

RPA - 16L

27° Beam, Round Large Open

TEST DATE	2019-07-12
SERIES	RPA3-16L-30K-27°- Round Large Open
LUMENS	1590.2 LM
WATTS	20 W
CCT	3000K

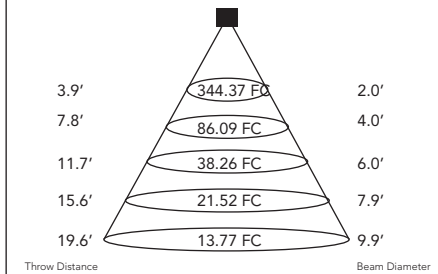

Zone	Lumens	%Lamp	%Luminaire
0-30	1,409.6	88.6%	88.6%
0-40	1,517.8	95.4%	95.4%
0-60	1,579.5	99.3%	99.3%
60-90	11.0	0.7%	0.7%
0-90	1,590.5	100%	100%

Zone Lumen Summary

RPA - 16L

35° Beam, Round Large Open

TEST DATE	2019-07-12
SERIES	RPA3-16L-30K-35°- Round Large Open
LUMENS	1648.7 LM
WATTS	20 W
CCT	3000K

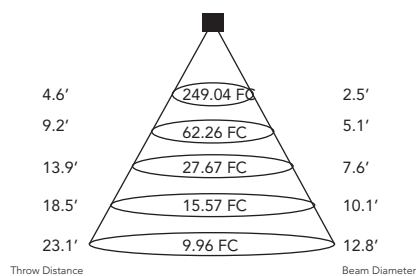

Zone	Lumens	%Lamp	%Luminaire
0-30	1,434.0	87%	87%
0-40	1,571.9	95.3%	95.3%
0-60	1,639.1	99.4%	99.4%
60-90	9.7	0.6%	0.6%
0-90	1,648.7	100%	100%

Zone Lumen Summary

RPA - 16L

45° Beam, Round Large Open

TEST DATE	2019-07-12
SERIES	RPA3-16L-30K-45°- Round Large Open
LUMENS	1570 LM
WATTS	20 W
CCT	3000K

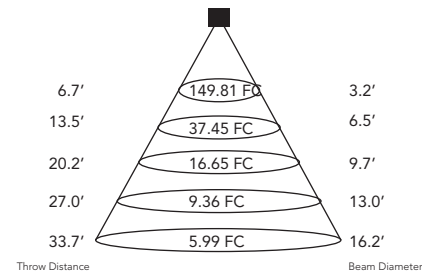

Zone	Lumens	%Lamp	%Luminaire
0-30	1,136.4	72.4%	72.4%
0-40	1,416.0	90.2%	90.2%
0-60	1,557.0	99.2%	99.2%
60-90	12.5	0.8%	0.8%
0-90	1,569.5	100%	100%

Zone Lumen Summary

[CLICK HERE OR VISIT PRODUCT PAGE FOR COMPREHENSIVE TECHNICAL INFORMATION](#)

PRIME

PRIME 3" LED ARCHITECTURAL
ROUND FLANGED DOWNLIGHT

AT-A-GLANCE TECHNICAL INFORMATION

3" PRIME DOWNLIGHT

RPA - 8L 12° Beam, Round Small Open

TEST DATE	2019-07-12
SERIES	RPA3-8L-30K-12°- Round Small Open
LUMENS	841.1 LM
WATTS	10 W
CCT	3000K

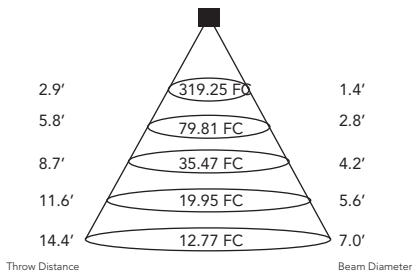

Zone	Lumens	%Lamp	%Luminaire
0-30	761.4	90.5%	90.4%
0-40	803.6	95.5%	95.4%
0-60	838.9	99.7%	99.6%
60-90	3.7	0.4%	0.4%
0-90	842.6	100.2%	100%

Zone Lumen Summary

RPA - 8L 22° Beam, Round Small Open

TEST DATE	2019-07-12
SERIES	RPA3-8L-30K-22°- Round Small Open
LUMENS	831.7 LM
WATTS	10 W
CCT	3000K

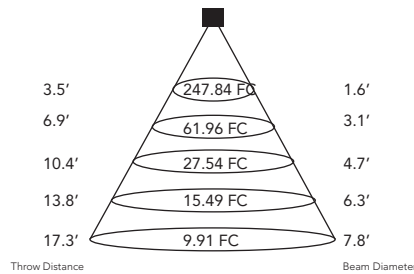

Zone	Lumens	%Lamp	%Luminaire
0-30	742.8	89.3%	89.2%
0-40	795.6	95.7%	95.5%
0-60	829.1	99.7%	99.6%
60-90	3.6	0.4%	0.4%
0-90	832.7	100.1%	100%

Zone Lumen Summary

RPA - 8L 27° Beam, Round Small Open

TEST DATE	2019-07-12
SERIES	RPA3-8L-30K-27°- Round Small Open
LUMENS	865.1 LM
WATTS	10 W
CCT	3000K

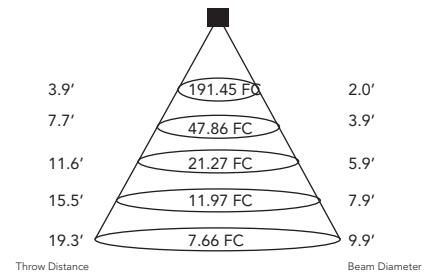

Zone	Lumens	%Lamp	%Luminaire
0-30	773.4	89.4%	89.4%
0-40	829.1	95.8%	95.8%
0-60	862.2	99.7%	99.6%
60-90	3.3	0.4%	0.4%
0-90	865.5	100.1%	100%

Zone Lumen Summary

RPA - 8L 35° Beam, Round Small Open

TEST DATE	2019-07-12
SERIES	RPA3-8L-30K-35°- Round Small Open
LUMENS	887.4 LM
WATTS	10 W
CCT	3000K

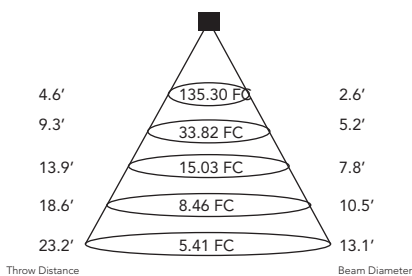

Zone	Lumens	%Lamp	%Luminaire
0-30	775.1	87.3%	87.3%
0-40	848.6	95.6%	95.6%
0-60	884.6	99.7%	99.7%
60-90	2.8	0.3%	0.3%
0-90	887.4	100%	100%

Zone Lumen Summary

RPA - 8L 45° Beam, Round Small Open

TEST DATE	2019-07-12
SERIES	RPA3-8L-30K-45°- Round Small Open
LUMENS	861.7 LM
WATTS	10 W
CCT	3000K

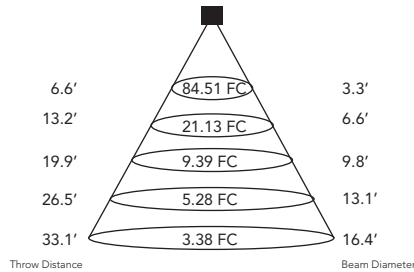

Zone	Lumens	%Lamp	%Luminaire
0-30	632.3	73.4%	73.4%
0-40	784.5	91%	91.1%
0-60	858.1	99.6%	99.6%
60-90	3.3	0.4%	0.4%
0-90	861.4	100%	100%

Zone Lumen Summary

[CLICK HERE OR VISIT PRODUCT PAGE FOR COMPREHENSIVE TECHNICAL INFORMATION](#)

PRIME

PRIME 3" LED ARCHITECTURAL
ROUND FLANGED DOWNLIGHT

AT-A-GLANCE TECHNICAL INFORMATION

3" PRIME DOWNLIGHT

RPA - 11L

12° Beam, Round Small Open

TEST DATE	2019-07-12
SERIES	RPA3-11L-30K-12°- Round Small Open
LUMENS	1125.7 LM
WATTS	14 W
CCT	3000K

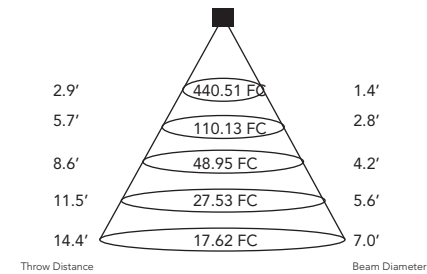

Zone	Lumens	%Lamp	%Luminaire
0-30	1,026.6	91.2%	91%
0-40	1,080.0	95.9%	95.8%
0-60	1,123.1	99.8%	99.6%
60-90	4.5	0.4%	0.4%
0-90	1,127.6	100.2%	100%

Zone Lumen Summary

RPA - 11L

22° Beam, Round Small Open

TEST DATE	2019-07-12
SERIES	RPA3-11L-30K-22°- Round Small Open
LUMENS	1123.5 LM
WATTS	14 W
CCT	3000K

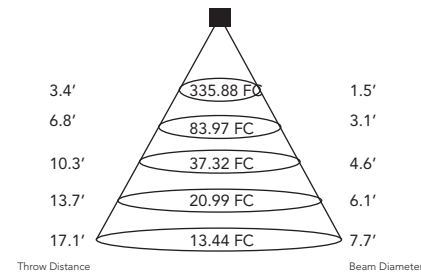

Zone	Lumens	%Lamp	%Luminaire
0-30	1,003.5	89.3%	89.2%
0-40	1,074.7	95.7%	95.5%
0-60	1,119.7	99.7%	99.5%
60-90	5.2	0.5%	0.5%
0-90	1,124.9	100.1%	100%

Zone Lumen Summary

RPA - 11L

27° Beam, Round Small Open

TEST DATE	2019-07-12
SERIES	RPA3-11L-30K-27°- Round Small Open
LUMENS	1173.8 LM
WATTS	14 W
CCT	3000K

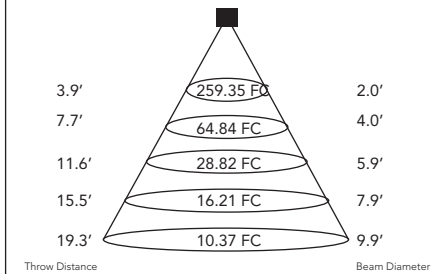

Zone	Lumens	%Lamp	%Luminaire
0-30	1,049.4	89.4%	89.4%
0-40	1,124.5	95.8%	95.8%
0-60	1,169.2	99.6%	99.6%
60-90	4.8	0.4%	0.4%
0-90	1,173.9	100%	100%

Zone Lumen Summary

RPA - 11L

35° Beam, Round Small Open

TEST DATE	2019-07-12
SERIES	RPA3-11L-30K-35°- Round Small Open
LUMENS	1199.6 LM
WATTS	14 W
CCT	3000K

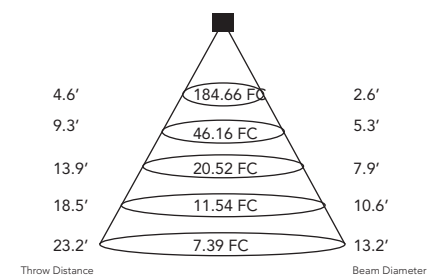

Zone	Lumens	%Lamp	%Luminaire
0-30	1,051.5	87.7%	87.7%
0-40	1,148.6	95.7%	95.7%
0-60	1,195.7	99.7%	99.7%
60-90	4.0	0.3%	0.3%
0-90	1,199.7	100%	100%

Zone Lumen Summary

RPA - 11L

45° Beam, Round Small Open

TEST DATE	2019-07-12
SERIES	RPA3-11L-30K-45°- Round Small Open
LUMENS	1164.7 LM
WATTS	14 W
CCT	3000K

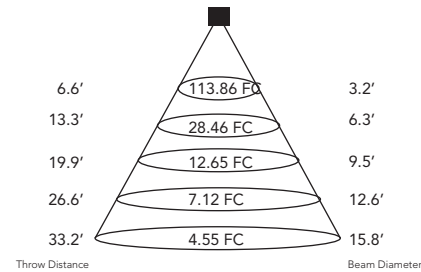

Zone	Lumens	%Lamp	%Luminaire
0-30	850.5	73%	73%
0-40	1,057.7	90.8%	90.8%
0-60	1,159.6	99.6%	99.6%
60-90	5.0	0.4%	0.4%
0-90	1,164.6	100%	100%

Zone Lumen Summary

[CLICK HERE OR VISIT PRODUCT PAGE FOR COMPREHENSIVE TECHNICAL INFORMATION](#)

PRIME

PRIME 3" LED ARCHITECTURAL
ROUND FLANGED DOWNLIGHT

AT-A-GLANCE TECHNICAL INFORMATION

3" PRIME DOWNLIGHT

RPA - 16L

12° Beam, Round Small Open

TEST DATE	2019-07-12
SERIES	RPA3-16L-30K-12°- Round Small Open
LUMENS	1529.4 LM
WATTS	20 W
CCT	3000K

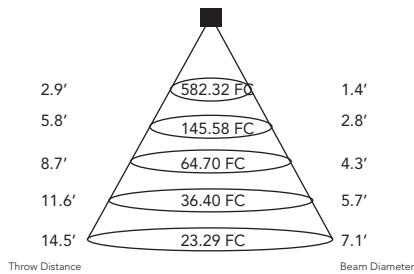

Zone	Lumens	%Lamp	%Luminaire
0-30	1,385.8	90.6%	90.5%
0-40	1,461.0	95.5%	95.4%
0-60	1,524.5	99.7%	99.5%
60-90	7.6	0.5%	0.5%
0-90	1,532.1	100.2%	100%

Zone Lumen Summary

RPA - 16L

22° Beam, Round Small Open

TEST DATE	2019-07-12
SERIES	RPA3-16L-30K-22°- Round Small Open
LUMENS	1514.4 LM
WATTS	20 W
CCT	3000K

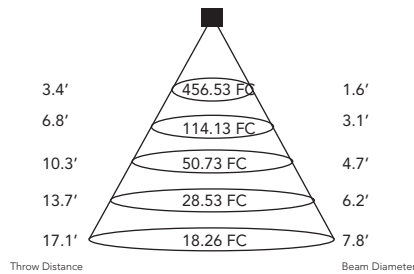

Zone	Lumens	%Lamp	%Luminaire
0-30	1,357.4	89.6%	89.5%
0-40	1,450.2	95.8%	95.7%
0-60	1,509.0	99.6%	99.5%
60-90	7.2	0.5%	0.5%
0-90	1,516.1	100.1%	100%

Zone Lumen Summary

RPA - 16L

27° Beam, Round Small Open

TEST DATE	2019-07-12
SERIES	RPA3-16L-30K-27°- Round Small Open
LUMENS	1578.4 LM
WATTS	20 W
CCT	3000K

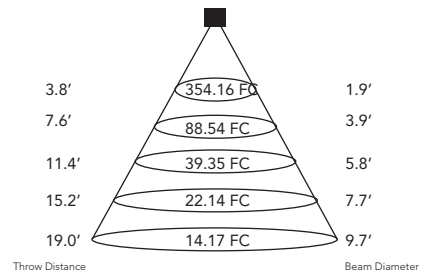

Zone	Lumens	%Lamp	%Luminaire
0-30	1,411.7	89.4%	89.4%
0-40	1,512.3	95.8%	95.7%
0-60	1,572.6	99.6%	99.6%
60-90	6.9	0.4%	0.4%
0-90	1,579.4	100.1%	100%

Zone Lumen Summary

RPA - 16L

35° Beam, Round Small Open

TEST DATE	2019-07-12
SERIES	RPA3-16L-30K-35°- Round Small Open
LUMENS	1622.3 LM
WATTS	20 W
CCT	3000K

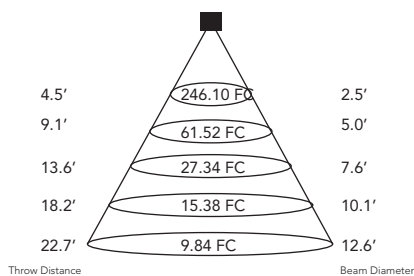

Zone	Lumens	%Lamp	%Luminaire
0-30	1,417.5	87.4%	87.4%
0-40	1,551.2	95.6%	95.6%
0-60	1,616.2	99.6%	99.6%
60-90	5.9	0.4%	0.4%
0-90	1,622.0	100%	100%

Zone Lumen Summary

RPA - 16L

45° Beam, Round Small Open

TEST DATE	2019-07-12
SERIES	RPA3-16L-30K-45°- Round Small Open
LUMENS	1575.7 LM
WATTS	20 W
CCT	3000K

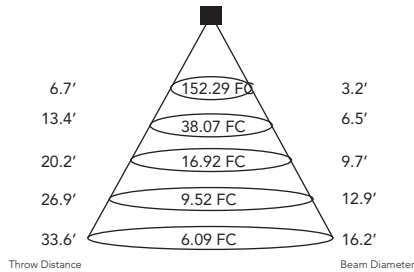

Zone	Lumens	%Lamp	%Luminaire
0-30	1,149.1	72.9%	72.9%
0-40	1,429.4	90.7%	90.7%
0-60	1,568.1	99.5%	99.5%
60-90	7.1	0.5%	0.5%
0-90	1,575.2	100%	100%

Zone Lumen Summary

[CLICK HERE OR VISIT PRODUCT PAGE FOR COMPREHENSIVE TECHNICAL INFORMATION](#)