

PRIME

PRIME 3" SHALLOW LED ARCHITECTURAL ROUND FLANGED WALL WASH

JOB INFORMATION	TYPE:
	CATALOG NO.
	PROJECT NAME:
	COMMENTS:
	PREPARED BY:

USE OF PRODUCT

The 3" PRIME Wall Wash is a small aperture fixture with shallow height that may be used in residential and commercial applications. Available with die cast or spun aluminum trims, with an assortment of color temperatures, optics and dimmable drivers.

PRIME FEATURES

Color Temperature: 2700K, 3000K, 3500K, or 4000K
 SDCM: 2 step binning
 Color Rendering Index: 93+ CRI
 Optical Lens: 12°, 22°, 27°, 35°, 45°
 Trim: Die cast or spun aluminum
 LED Life: 50,000 Hours
 LED Type: Cree LED
 Driver Info: 120-277V, 50/60 Hz, PF>0.9, THD<0.20
 Warranty: 5 year limited warranty

LED ENGINE

LED engine available with CREE LEDs in 2700K, 3000K, 3500K, or 4000K in standard 93+ CRI. 2 Step MacAdam ellipse allows for color consistency between fixtures. LED mounted to aluminum heat sink for maximum life output and thermal management. LED engine is accessible from below ceiling.

FRAME CONSTRUCTION

IC Air-tight rated housing constructed from 16 gauge heavy duty powder coated cold rolled steel frame. Junction box with 1/2" knockouts. Butterfly bracket included to accommodate adjustable bar hangers or C-channel (ordered separately).

ADJUSTMENT

- Light engine locked at 25° tilt, consult factory for other tilt setting.
 - Housing provides for 359° locking rotation
 - Aperture collar compatible up to 1½" ceiling thickness.
 - Accommodation for 2" or 3" ceiling thickness available upon request.

OPTICAL LENS & FILTERS (Field Replaceable)

Field replaceable optical lens available in 12°, 22°, 27°, 35° and 45°. Easily achieve narrow spot to wide flood beam pattern. Accepts up to 2 filters.

DIMMING

Available in 8 driver selections. (ID) Standard all-inclusive ELV(120V), Triac(120V), and 0-10V(120-277V) dimming driver called Intelligent Drive, 120-277V. (PEQ0) Lutron Hi-Lume Premier Ecosystem 0.1% w/soft on, fade to black dimming, 120-277V. (LDE1) Lutron Hi-Lume 1% Ecosystem with soft on, fade to black dimming, 120-277V. (L3DA) Hi-lume 1% EcoSystem/3-Wire L3D Driver (EEL) eldoLED Eco 1% Dim (0-10V), 120-277V. (EDIO) eldoLED Solo 0.1% Dim(0-10V), 120-277V. (EDID) eldoLED Solo 0.1% Dim(DALI), 120-277V. Driver accessible from below ceiling.

THERMAL MANAGEMENT

Ambient temperatures at fixture location should not exceed -20° to 40°C.

EMERGENCY BATTERY

Optional emergency battery available for a minimum of 90 minutes with remote test switch in 800 delivered lumens.

TRIM

Trim available in die cast or spun aluminum. Consult factory for made to order finishes. Flanged trim is compatible with all ceiling materials.

LABELS/COMPLIANCE/WARRANTY

- CSA Listed for US and Canada
 - Energy Star
 - Dry/Damp/Wet location rated.
 - Title 24, JA8 Compliant
 - 5 Year limited warranty.

ORDERING INFO

RPA3						
Series	Lumens	Color Temp	Voltage	Dimming	Optical Lens	Filter
PRIME	7 - 790 lm	27 - 2700K	UNV - 120-277V	ID ¹ - Standard all-inclusive ELV, Triac, and 0-10V dimming driver (Intelligent Drive)	12 - 12°	None - Leave blank
SERIES	10 - 1065 lm	30 - 3000K	120 - 120V	PEQ0 ² - Lutron Hi-lume Premier Ecosystem 0.1% w/soft on, fade to black dimming	22 - 22°	F - Frosted
	14 - 1415 lm	35 - 3500K	347 - 347V	LDE1 ² - Lutron Hi-Lume 1% Ecosystem with soft on, fade to black dimming	27 - 27°	H - Honeycomb
		40 - 4000K		LTE ² - Hi-Lume 1% 2-wire	35 - 35°	S - Solite
				L3DA - Hi-lume 1% EcoSystem/3-Wire L3D Driver	45 - 45°	L - Linear
				EEL ³ - eldoLED Eco 1% Dim (0-10V)		
				EDIO ³ - eldoLED Solo 0.1% Dim (0-10V)		
				EDID ³ - eldoLED Solo 0.1% Dim (DALI)		



Housing Type	Aperture	Frame Accessories	Collar	Option
IC - IC Air-tight Shallow New Construction	RFW - Round Flanged Wall Wash	AH - Adjustable bar hanger C - C Channel bar hanger B - Flat bar hanger	Blank - 1.5" Depth 20 - 2" Depth 30 - 3" Depth MTO - Made to order	ER8 ² - Emergency battery with remote switch (800 Lumens) CP - Chicago Plenum

1. Intelligent Drive is the standard driver.
 2. Ceiling access required.
 3. Must specify logarithmic or linear eldoLED driver.

TRIM ORDERING INFORMATION

Aperture Size / Shape / Trim Type / Style	Bevel Opening	Bevel	Flange	Options
3RFA - 3" Round Flange Accent	Die Cast			
	CL - Die cast opening	W - White H - Haze B - Black BZ - Bronze C - Clear MTO - Made to order	W - White B - Black BZ - Bronze MTO - Made to order	WL - Wet location
3RFA - 3" Round Flange Accent	Spun Aluminum (Self flanged)			
	AL - Spun alum. opening	H - Haze C - Clear MTO - Made to order		WL - Wet location

PRIME

PRIME 3" SHALLOW LED ARCHITECTURAL ROUND FLANGED WALL WASH

DIMENSIONS

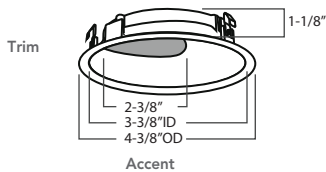
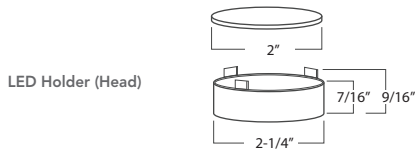
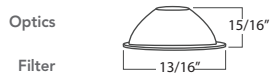
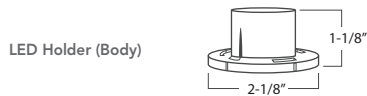
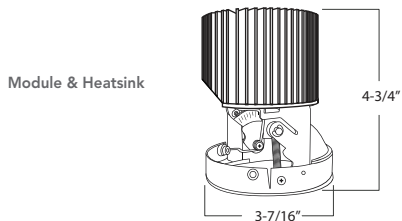
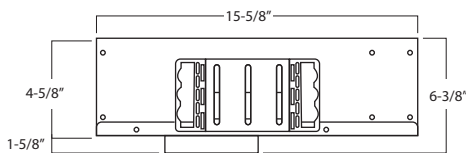
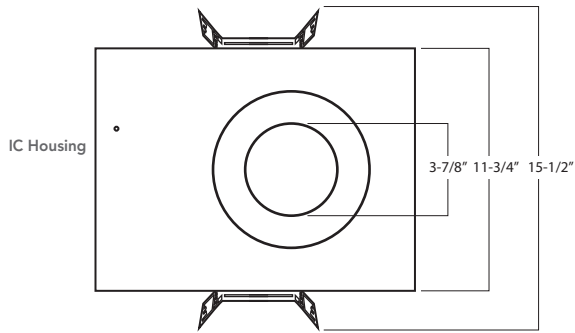

TRIM THICKNESS

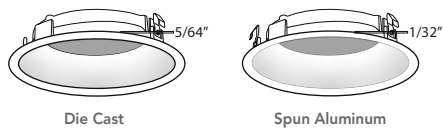

LUMEN CHART

Wattage	Delivered Lumens	Voltage	CRI
10W	790 Lm	120-277V	93+
14W	1065 Lm	120-277V	93+
20W	1415 Lm	120-277V	93+

*Above chart and ordering information reflect delivered lumens based on 3000K, 35° optical lens, with white bevel.
 **Lumens will vary based on CCT, optical lens, and bevel finish

FRAME ACCESSORIES

B

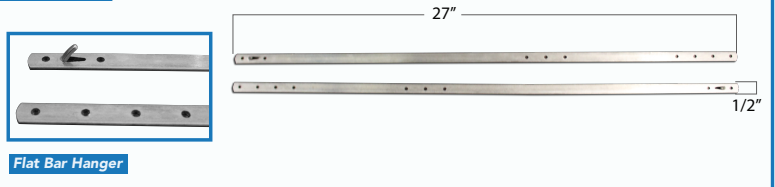

Flat Bar Hanger

C

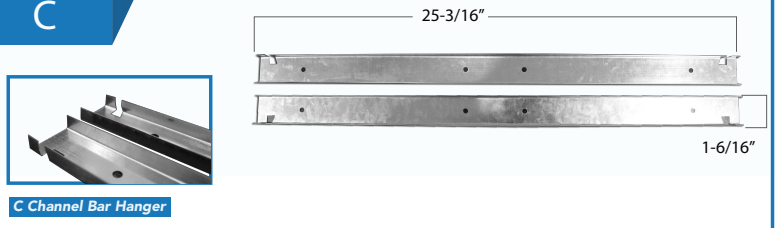

C Channel Bar Hanger

AH

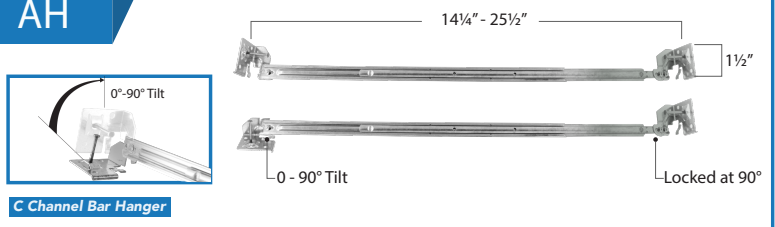

C Channel Bar Hanger

COLLAR DEPTH PER CEILING THICKNESS

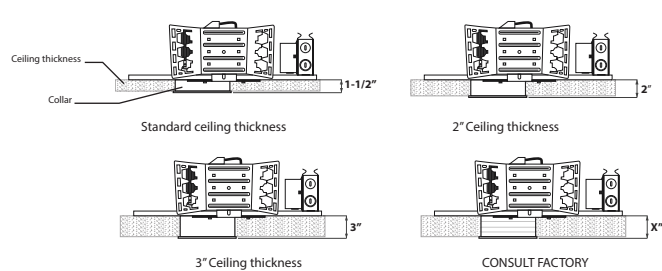

CONSULT FACTORY

PRIME

PRIME 3" LED ARCHITECTURAL
ROUND FLANGED WALL WASH

AT-A-GLANCE TECHNICAL INFORMATION

3" PRIME WALL WASH

RPA - 7L

12° Beam, Round Accent

TEST DATE	2019-07-12
SERIES	RPA3-7L-30K-12°- Round Accent
LUMENS	699 LM
WATTS	10 W
CCT	3000K

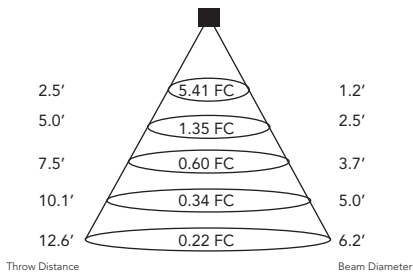

Zone	Lumens	%Lamp	%Luminaire
0-30	358.0	51.2%	51.2%
0-40	615.2	88%	88%
0-60	693.7	99.2%	99.2%
60-90	5.5	0.8%	0.8%
0-90	699.2	100%	100%

Zone Lumen Summary

RPA - 7L

22° Beam, Round Accent

TEST DATE	2019-07-12
SERIES	RPA3-7L-30K-22°- Round Accent
LUMENS	699.5 LM
WATTS	10 W
CCT	3000K

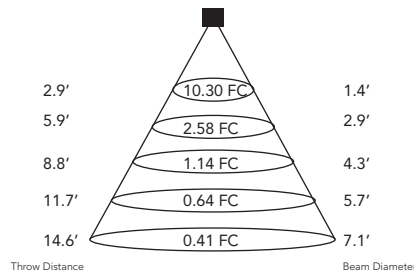

Zone	Lumens	%Lamp	%Luminaire
0-30	373.7	53.4%	53.4%
0-40	614.8	87.9%	87.9%
0-60	693.3	99.1%	99.1%
60-90	6.1	0.9%	0.9%
0-90	699.4	100%	100%

Zone Lumen Summary

RPA - 7L

27° Beam, Round Accent

TEST DATE	2019-07-12
SERIES	RPA3-7L-30K-27°- Round Accent
LUMENS	757.1 LM
WATTS	10 W
CCT	3000K

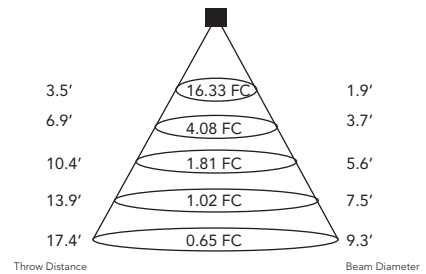

Zone	Lumens	%Lamp	%Luminaire
0-30	443.9	58.6%	58.7%
0-40	670.2	88.5%	88.6%
0-60	751.1	99.2%	99.3%
60-90	5.3	0.7%	0.7%
0-90	756.5	99.9%	100%

Zone Lumen Summary

RPA - 7L

35° Beam, Round Accent

TEST DATE	2019-07-12
SERIES	RPA3-7L-30K-35°- Round Accent
LUMENS	794.3 LM
WATTS	10 W
CCT	3000K

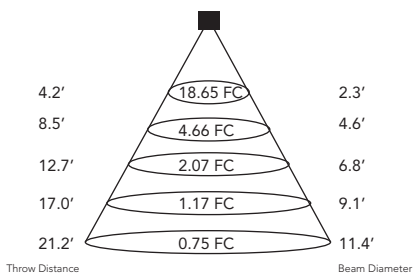

Zone	Lumens	%Lamp	%Luminaire
0-30	401.9	50.6%	50.6%
0-40	645.3	81.2%	81.3%
0-60	787.7	99.2%	99.2%
60-90	6.5	0.8%	0.8%
0-90	794.2	100%	100%

Zone Lumen Summary

RPA - 7L

45° Beam, Round Accent

TEST DATE	2019-07-12
SERIES	RPA3-7L-30K-45°- Round Accent
LUMENS	727.5 LM
WATTS	10 W
CCT	3000K

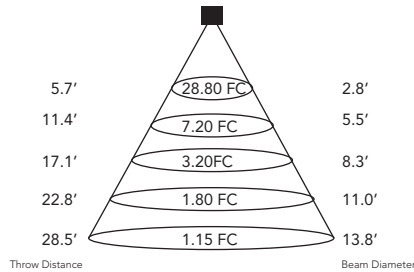

Zone	Lumens	%Lamp	%Luminaire
0-30	368.3	50.6%	50.6%
0-40	562.5	77.3%	77.3%
0-60	715.5	98.3%	98.3%
60-90	11.9	1.6%	1.6%
0-90	727.4	100%	100%

Zone Lumen Summary

[CLICK HERE OR VISIT PRODUCT PAGE FOR COMPREHENSIVE TECHNICAL INFORMATION](#)

PRIME

PRIME 3" LED ARCHITECTURAL
ROUND FLANGED WALL WASH

3" PRIME WALL WASH

AT-A-GLANCE TECHNICAL INFORMATION

RPA - 10L 12° Beam, Round Accent

TEST DATE	2019-07-12
SERIES	RPA3-10L-30K-12°- Round Accent
LUMENS	947.5 LM
WATTS	14 W
CCT	3000K

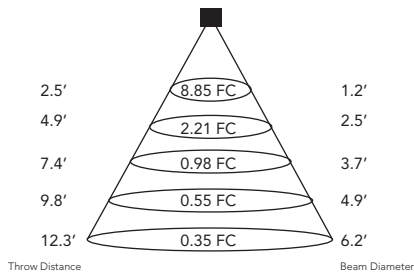

Zone	Lumens	%Lamp	%Luminaire
0-30	502.4	53%	53.1%
0-40	845.5	89.2%	98.3%
0-60	939.6	99.2%	99.3%
60-90	6.9	0.7%	0.7%
0-90	946.5	99.9%	100%

Zone Lumen Summary

RPA - 10L 22° Beam, Round Accent

TEST DATE	2019-07-12
SERIES	RPA3-10L-30K-22°- Round Accent
LUMENS	944.2 LM
WATTS	14 W
CCT	3000K

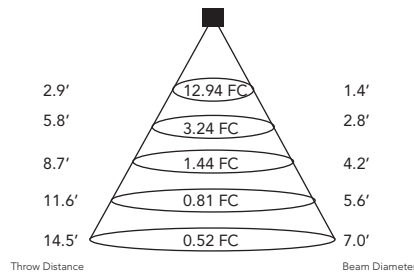

Zone	Lumens	%Lamp	%Luminaire
0-30	461.9	48.9%	49%
0-40	812.7	86.1%	86.1%
0-60	935.0	99%	99.1%
60-90	8.6	0.9%	0.9%
0-90	943.6	99.9%	100%

Zone Lumen Summary

RPA - 10L 27° Beam, Round Accent

TEST DATE	2019-07-12
SERIES	RPA3-10L-30K-27°- Round Accent
LUMENS	1015.4 LM
WATTS	14 W
CCT	3000K

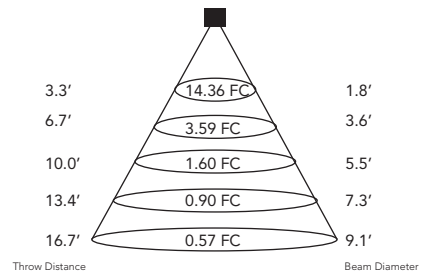

Zone	Lumens	%Lamp	%Luminaire
0-30	473.7	46.7%	46.7%
0-40	830.2	81.8%	81.8%
0-60	1,005.4	99%	99.1%
60-90	9.3	0.9%	0.9%
0-90	1,014.7	99.9%	100%

Zone Lumen Summary

RPA - 10L 35° Beam, Round Accent

TEST DATE	2019-07-12
SERIES	RPA3-10L-30K-35°- Round Accent
LUMENS	1066.2 LM
WATTS	14 W
CCT	3000K

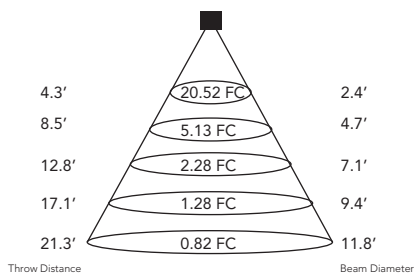

Zone	Lumens	%Lamp	%Luminaire
0-30	533.2	50%	50%
0-40	854.0	80.1%	80.1%
0-60	1,055.5	99%	99.1%
60-90	10.0	0.9%	0.9%
0-90	1,065.5	99.9%	100%

Zone Lumen Summary

RPA - 10L 45° Beam, Round Accent

TEST DATE	2019-07-12
SERIES	RPA3-10L-30K-45°- Round Accent
LUMENS	977.1 LM
WATTS	14 W
CCT	3000K

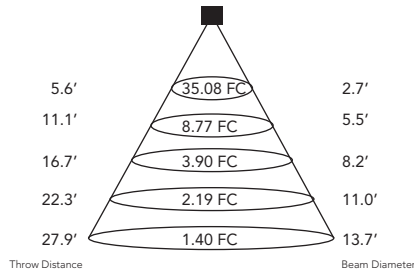

Zone	Lumens	%Lamp	%Luminaire
0-30	482.3	49.4%	49.4%
0-40	746.5	76.4%	76.4%
0-60	960.1	98.3%	98.3%
60-90	16.4	1.7%	1.7%
0-90	976.5	99.9%	100%

Zone Lumen Summary

[CLICK HERE OR VISIT PRODUCT PAGE FOR COMPREHENSIVE TECHNICAL INFORMATION](#)

PRIME

PRIME 3" LED ARCHITECTURAL
ROUND FLANGED WALL WASH

3" PRIME WALL WASH

AT-A-GLANCE TECHNICAL INFORMATION

RPA - 14L 12° Beam, Round Accent

TEST DATE 2019-07-12
SERIES RPA3-14L-30K-12°- Round Accent
LUMENS 1310.1 LM
WATTS 20 W
CCT 3000K

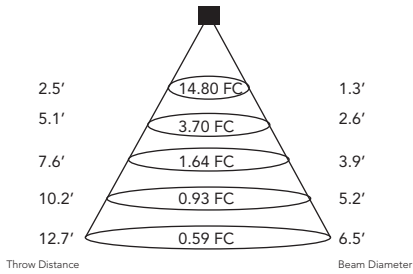

Zone	Lumens	%Lamp	%Luminaire
0-30	793.9	60.6%	60.7%
0-40	1,200.7	91.6%	91.8%
0-60	1,300.1	99.2%	99.4%
60-90	8.4	0.6%	0.6%
0-90	1,308.5	99.9%	100%

Zone Lumen Summary

RPA - 14L 22° Beam, Round Accent

TEST DATE 2019-07-12
SERIES RPA3-14L-30K-22°- Round Accent
LUMENS 1300.5 LM
WATTS 20 W
CCT 3000K

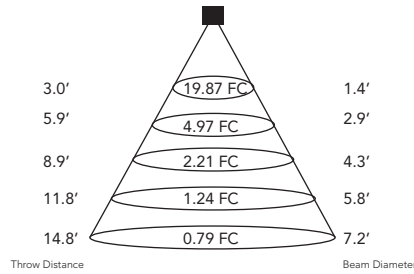

Zone	Lumens	%Lamp	%Luminaire
0-30	658.8	50.7%	50.7%
0-40	1,128.3	86.8%	86.8%
0-60	1,287.7	99%	99.1%
60-90	12.0	0.9%	0.9%
0-90	1,299.6	99.9%	100%

Zone Lumen Summary

RPA - 14L 27° Beam, Round Accent

TEST DATE 2019-07-12
SERIES RPA3-14L-30K-27°- Round Accent
LUMENS 1342.3 LM
WATTS 20 W
CCT 3000K

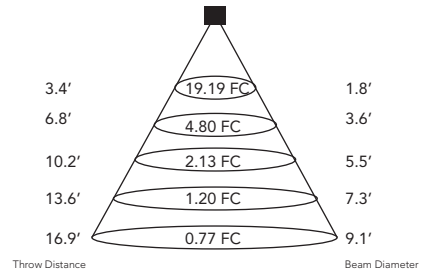

Zone	Lumens	%Lamp	%Luminaire
0-30	640.4	47.7%	47.7%
0-40	1,106.2	82.4%	82.4%
0-60	1,329.4	99%	99%
60-90	12.5	0.9%	0.9%
0-90	1,341.9	100%	100%

Zone Lumen Summary

RPA - 14L 35° Beam, Round Accent

TEST DATE 2019-07-12
SERIES RPA3-14L-30K-35°- Round Accent
LUMENS 1417.1 LM
WATTS 20 W
CCT 3000K

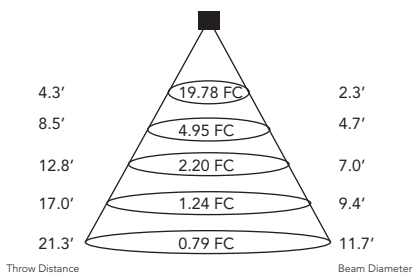

Zone	Lumens	%Lamp	%Luminaire
0-30	630.5	44.5%	44.5%
0-40	1,074.1	75.8%	75.8%
0-60	1,399.6	98.8%	98.8%
60-90	17.1	1.2%	1.2%
0-90	1,416.7	100%	100%

Zone Lumen Summary

RPA - 14L 45° Beam, Round Accent

TEST DATE 2019-07-12
SERIES RPA3-14L-30K-45°- Round Accent
LUMENS 1288.4 LM
WATTS 20 W
CCT 3000K

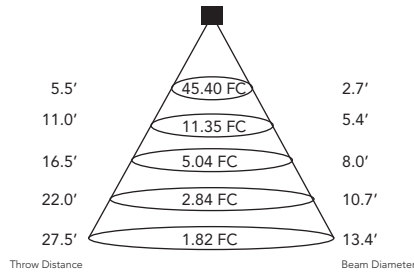

Zone	Lumens	%Lamp	%Luminaire
0-30	607.7	47.2%	47.2%
0-40	962.4	74.7%	74.7%
0-60	1,263.6	98.1%	98.1%
60-90	24.6	1.9%	1.9%
0-90	1,288.2	100%	100%

Zone Lumen Summary

[CLICK HERE OR VISIT PRODUCT PAGE FOR COMPREHENSIVE TECHNICAL INFORMATION](#)