

PRIME

PRIME 6" LED ARCHITECTURAL SQUARE FLANGED OPEN/ACCENT TRIM ADJUSTABLE

JOB INFORMATION	TYPE:
	CATALOG NO.
	PROJECT NAME:
	COMMENTS:
	PREPARED BY:

USE OF PRODUCT

The 6" Prime Adjustable Series Downlight is the ideal product for architectural energy efficient lighting in commercial and residential applications where adjustability is required. Available in an assortment of color temperatures, optics, lumen outputs, and dimmable driver options.

PRIME FEATURES

Color Temperature: 2700K, 3000K, 3500K, or 4000K
SDCM: 2 step binning
Color Rendering Index: 93+ CRI
Optical Lens: 18°, 30°, 50°, 80°
Trim: Die cast or anodized
LED Life: 50,000 Hours
LED Type: Cree LED
Driver Info: 120-277V, 50/60 Hz, PF>0.9, THD<0.20
Warranty: 5 year limited warranty

LED ENGINE

LED engine available with CREE LEDs in 2700K, 3000K, 3500K, or 4000K in standard 93+ CRI. 2 Step MacAdam ellipse allows for color consistency between fixtures. LED mounted to aluminum heat sink for maximum life output and thermal management. Light engine provides a quick disconnect with locking strain relief to housing.

FRAME CONSTRUCTION

Constructed from 16 gauge heavy duty powder coated cold rolled steel frame with a large access junction box.

ADJUSTMENT

- Light engine allows for hot aiming from 0-35°.
- Housing provides for 360° locking rotation
- Aperture collar adjusts 15°± horizontally within frame for square ceiling alignment
- Collar notch allows for easy alignment for square applications.
- Aperture collar compatible up to 1½" ceiling thickness.
- Accommodation for 2" or 3" ceiling thickness available upon request.

OPTICS

Field replaceable optical lens available in 18°, 30°, 50°, and 80°. Easily achieve narrow spot to wide flood beam pattern. Option for frosted, honeycomb, or solite filter (2 maximum).

DIMMING

Available in 8 driver selections. (ID) Standard all-inclusive ELV, Triac, and 0-10V dimming driver called Intelligent Drive, 120-277V. (PEQ0) Lutron Hi-Lume Premier Ecosystem 0.1% w/soft on, fade to black dimming, 120-277V. (LDE1) Lutron Hi-Lume 1% Ecosystem with soft on, fade to black dimming, 120-277V. (LTE) Lutron Hi-Lume 1% 2-wire, 120V. (L3DA) Hi-Lume 1% EcoSystem/3-Wire L3D Driver (EEI) eldoLED Eco 1% Dim (0-10V), 120-277V. (EDIO) eldoLED Solo 0.1% Dim(0-10V), 120-277V. (EDID) eldoLED Solo 0.1% Dim(DALI), 120-277V.

THERMAL MANAGEMENT

Ambient temperatures at fixture location should not exceed -20° to 40°C.

EMERGENCY BATTERY

Optional emergency battery available for a minimum of 90 minutes with both integral or remote test switch in 800 or 1700 delivered lumens.

TRIM OPTIONS

- All trims are self flanged die cast or anodized.
- Trim includes standard frosted acrylic diffuser.
- 12% lumens increase if remove standard frosted acrylic diffuser in field.
- Optical Enhancer reflects light evenly across the diffusion lens.
- Trims available in round or square in an assortment of standard or made to order finishes.

LABELS/COMPLIANCE/WARRANTY

- CSA Listed for US and Canada
- Energy Star
- Dry/Damp/Wet location rated.
- Title 24, JA8 Compliant
- 5 Year limited warranty



HOUSING ORDERING INFORMATION

RPA6						
Series	Lumens	Color Temp	Voltage	Dimming	Optical Lens ⁹	Filter
PRIME SERIES	10L ¹ - 1046 lm	27 - 2700K	UNV - 120-277V	ID ³ - Standard all-inclusive ELV, Triac, and 0-10V dimming driver (Intelligent Drive)	18 - 18°	None - Leave blank
	13L ¹ - 1345 lm	30 - 3000K	120 - 120V	PEQ0 ⁴ - Lutron Hi-Lume Premier Ecosystem 0.1% w/soft on, fade to black dimming	30 - 30°	F - Frosted filter
	16L ¹ - 1645 lm	35 - 3500K	347 ² - 347V	LDE1 ⁵ - Lutron Hi-Lume 1% Ecosystem with soft on, fade to black dimming	50 - 50°	H - Honeycomb
	21L ¹ - 2145 lm	40 - 4000K		LTE ^{5,6} - Lutron Hi-Lume 1% 2-wire	80 - 80°	S - Solite filter
	25L ¹ - 2505 lm			L3DA - Hi-Lume 1% EcoSystem/3-Wire L3D Driver		
	31L - 3095 lm			EEI ^{6,7,8} - eldoLED Eco 1% Dim (0-10V)		
	34L - 3485 lm			EDIO ^{6,7,8} - eldoLED Solo 0.1% Dim (0-10V)		
40L - 4040 lm			EDID ^{6,7,8} - eldoLED Solo 0.1% Dim (DALI)			

Housing Type	Aperture	Frame Accessories	Collar	Option
NC - Non-IC New Construction IC ¹⁰ - IC Air-tight New Construction	SFA - Square Flanged Adjustable	C - C Channel bar hanger B - Flat bar hanger	Blank - 1.5" Depth 20 - 2" Depth 30 - 3" Depth MTO - Made to order	EI8 - Emergency battery with integral switch(800 Lumens) ER8 - Emergency battery with remote switch (800 Lumens) EI17 - Emergency battery with integral switch(1700 Lumens) ER17 - Emergency battery with remote switch (1700 Lumens) FCJS-E - Vive wireless individual controller(Ecosystem) FCJS-O - Vive wireless individual controller(0-10) CP ¹⁰ - Chicago Plenum

TRIM ORDERING INFORMATION

Aperture Size / Shape / Trim Type / Style	Bevel / Flange Finish	Options
6SFO - 6" Square Flange Open 6SFA - 6" Square Flange Accent	W-W - White bevel / white flange H-W - Haze bevel / white flange B-B - Black bevel / black flange H-H - Haze bevel / Haze flange S-S - Specular clear bevel / Specular clear flange WE-WE - Wheat bevel / wheat flange MTO - Made to order	WL - Wet location

1. Compatible with IC new construction housing.
2. Step down transformer required.
3. Intelligent Drive is the standard driver.
4. Driver must not exceed 1645 lm
5. 120V only.
6. Inapplicable to 4040 Lumen offering.
7. Must specify logarithmic or linear eldoLED driver.
8. Confirm dimming curve: linear or logarithmic.
9. Without standard frosted acrylic diffuser.
10. Compatible up to 2145 lumens.

PRIME

PRIME 6" LED ARCHITECTURAL SQUARE FLANGED
OPEN/ACCENT TRIM ADJUSTABLE

JOB INFORMATION	TYPE:
	CATALOG NO.:
	PROJECT NAME:
	COMMENTS:
	PREPARED BY:

6" PRIME ADJUSTABLE

LUMEN CHART

Wattage	Delivered Lumens	Voltage	CRI
11W	1045 Lm	120-277V	93+
16W	1345 Lm	120-277V	93+
20W	1645 Lm	120-277V	93+
30W	2145 Lm	120-277V	93+
31W	2505 Lm	120-277V	93+
38W	3095 Lm	120-277V	93+
45W	3485 Lm	120-277V	93+
58W	4040 Lm	120-277V	93+

*Above chart, ordering information, and IES File name reflect delivered lumens based 3000K and 30° optical lens.
**Lumens will vary based on CCT, optical lens, and bevel finish.

DIMENSION

Open Trim Details

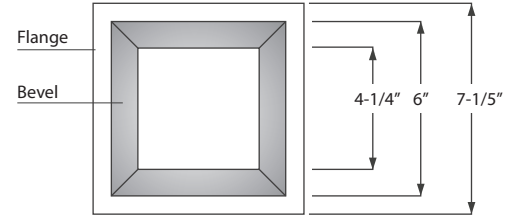
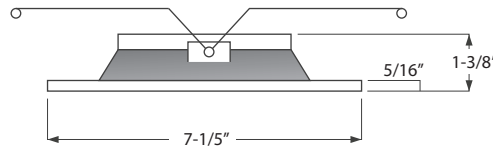
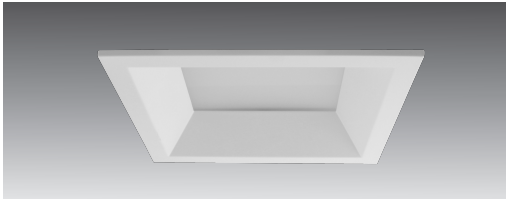

1 PIECE DIE CAST

Accent Trim Details

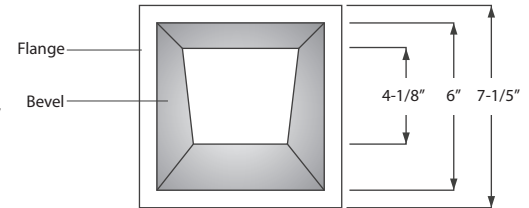
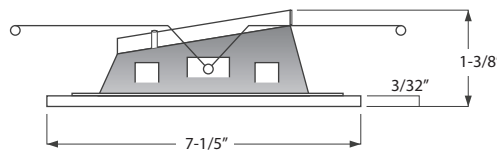
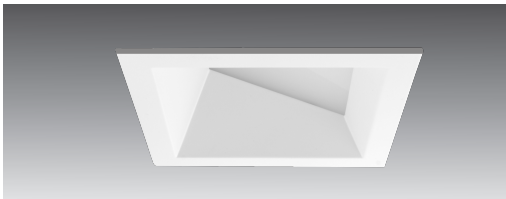

1 PIECE DIE CAST

LED HOLDER & FILTER DIMENSION

LED Holder and Filter

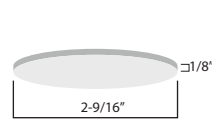
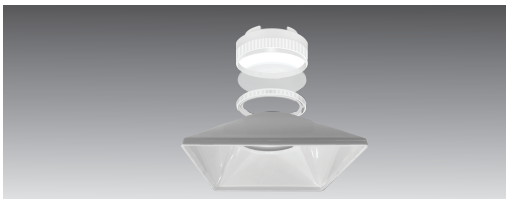

Filter

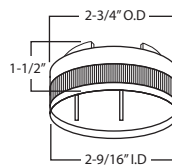

LED Holder

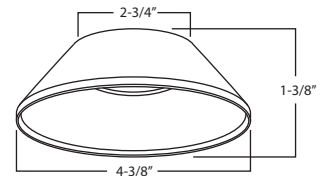
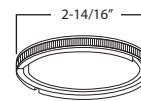

Light Enhancer

PRIME

PRIME 6" LED ARCHITECTURAL SQUARE FLANGED
OPEN/ACCENT TRIM ADJUSTABLE

JOB INFORMATION	TYPE:
	CATALOG NO.:
	PROJECT NAME:
	COMMENTS:
	PREPARED BY:

6" PRIME ADJUSTABLE

HOUSING DIMENSION

IC Housing Details

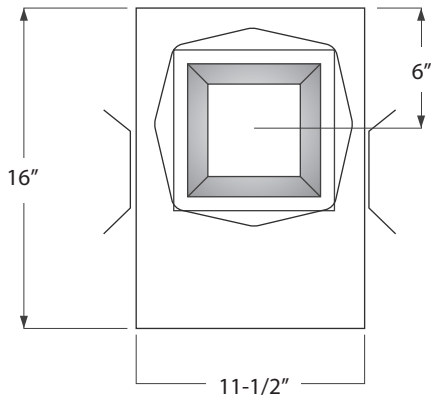
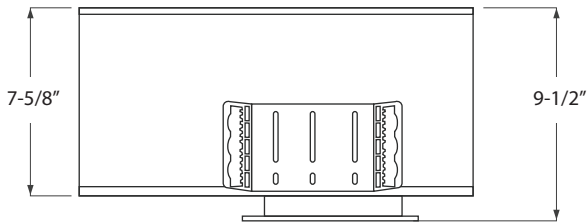

Non-IC Housing Details

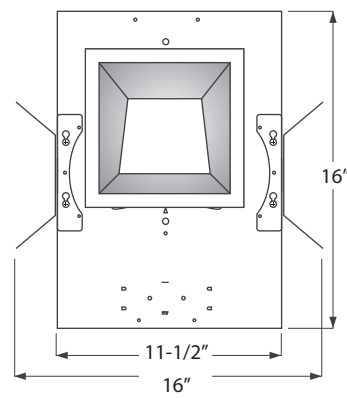
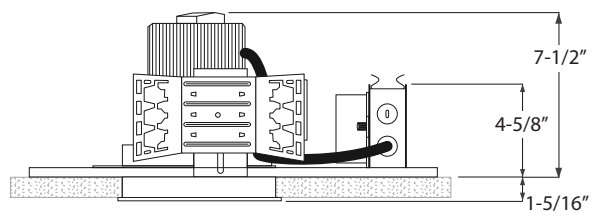
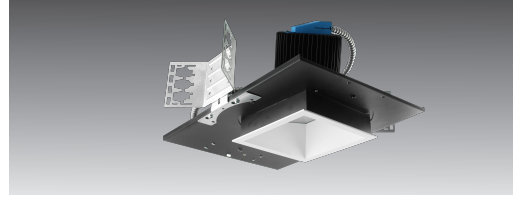

Ceiling Cut-out: 6-3/8 X 6-3/8"
Maximum Ceiling Thickness: 1-1/2"
Minimum Ceiling Thickness: 1/2"
Consult factory for custom ceiling thickness

COLLAR DEPTH PER CEILING THICKNESS

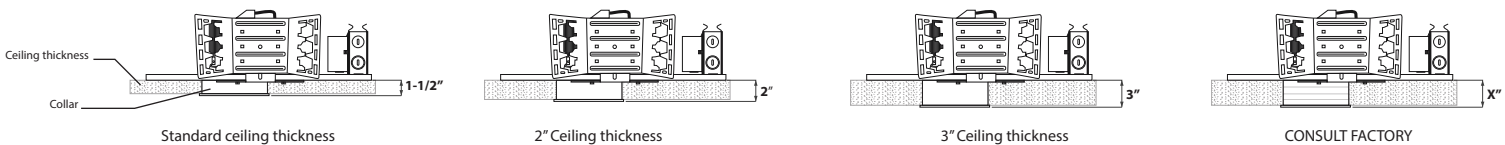

PRIME

PRIME 6" LED ARCHITECTURAL
SQUARE FLANGED ADJUSTABLE

6" PRIME ADJUSTABLE

AT-A-GLANCE TECHNICAL INFORMATION

RPA - 10L 18° BEAM

TEST DATE 2019-02-19
SERIES RPA6-10L-30K-18°-SFA
LUMENS 994.9 LM
WATTS 11.84 W
CCT 3000K

Zone	Lumens	%Lamp	%Luminaire
0-30	818.4	82.3%	82.2%
0-40	903.8	90.8%	90.8%
0-60	980.4	98.5%	98.5%
60-90	15.1	1.5%	1.5%
0-90	995.5	100.1%	100%

RPA - 10L 30° BEAM

TEST DATE 2019-02-19
SERIES RPA6-10L-30K-30°-SFA
LUMENS 1046.8 LM
WATTS 11.85 W
CCT 3000K

Zone	Lumens	%Lamp	%Luminaire
0-30	894.4	85.4%	85.4%
0-40	988.4	94.4%	94.4%
0-60	1,037.3	99.1%	99%
60-90	10.1	1%	1%
0-90	1,047.4	100.1%	100%

RPA - 10L 60° BEAM

TEST DATE 2019-02-19
SERIES RPA6-10L-30K-60°-SFA
LUMENS 989.6 LM
WATTS 11.85 W
CCT 3000K

Zone	Lumens	%Lamp	%Luminaire
0-30	732.3	74%	74%
0-40	899.0	90.8%	90.9%
0-60	974.3	98.5%	98.5%
60-90	15.0	1.5%	1.5%
0-90	989.3	100%	100%

RPA - 10L 80° BEAM

TEST DATE 2019-02-19
SERIES RPA6-10L-30K-80°-SFA
LUMENS 942 LM
WATTS 11.85 W
CCT 3000K

Zone	Lumens	%Lamp	%Luminaire
0-30	541.2	57.5%	57.5%
0-40	775.2	82.3%	82.4%
0-60	914.8	97.1%	97.2%
60-90	26.1	2.8%	2.8%
0-90	940.9	99.9%	100%

RPA - 13L 18° BEAM

TEST DATE 2019-02-19
SERIES RPA6-13L-30K-18°-SFA
LUMENS 1260.2 LM
WATTS 16.01 W
CCT 3000K

Zone	Lumens	%Lamp	%Luminaire
0-30	596.8	47.4%	47.4%
0-40	844.6	67%	67%
0-60	1,174.5	93.2%	93.2%
60-90	85.3	6.8%	6.8%
0-90	1,259.8	100%	100%

RPA - 13L 30° BEAM

TEST DATE 2019-02-19
SERIES RPA6-13L-30K-30°-SFA
LUMENS 1345.3 LM
WATTS 16.00 W
CCT 3000K

Zone	Lumens	%Lamp	%Luminaire
0-30	638.9	47.5%	47.5%
0-40	905.3	67.3%	67.3%
0-60	1,256.0	93.4%	93.4%
60-90	88.6	6.6%	6.6%
0-90	1,344.6	99.9%	100%

RPA - 13L 60° BEAM

TEST DATE 2019-02-19
SERIES RPA6-13L-30K-60°-SFA
LUMENS 1192.2 LM
WATTS 16.00 W
CCT 3000K

Zone	Lumens	%Lamp	%Luminaire
0-30	524.7	44%	44%
0-40	769.1	64.5%	64.5%
0-60	1,104.6	92.7%	92.7%
60-90	87.1	7.3%	7.3%
0-90	1,191.7	100%	100%

RPA - 13L 80° BEAM

TEST DATE 2019-02-19
SERIES RPA6-13L-30K-80°-SFA
LUMENS 1128.3 LM
WATTS 16.00 W
CCT 3000K

Zone	Lumens	%Lamp	%Luminaire
0-30	462.4	41%	41%
0-40	700.2	62.1%	62.1%
0-60	1,037.0	91.9%	92%
60-90	90.8	8%	8%
0-90	1,127.8	100%	100%

[CLICK HERE OR VISIT PRODUCT PAGE FOR COMPREHENSIVE TECHNICAL INFORMATION](#)

PRIME

PRIME 6" LED ARCHITECTURAL
SQUARE FLANGED ADJUSTABLE

6" PRIME ADJUSTABLE

AT-A-GLANCE TECHNICAL INFORMATION

RPA - 16L 18° BEAM

TEST DATE 2019-02-19
SERIES RPA6-16L-30K-18°-SFA
LUMENS 1561.9 LM
WATTS 20.62 W
CCT 3000K

Zone	Lumens	%Lamp	%Luminaire
0-30	1,284.0	92.2%	82.2%
0-40	1,418.0	90.8%	90.7%
0-60	1,538.5	98.5%	98.4%
60-90	24.4	1.6%	1.6%
0-90	1,562.9	100.1%	100%

RPA - 16L 30° BEAM

TEST DATE 2019-02-19
SERIES RPA6-16L-30K-30°-SFA
LUMENS 1647.3 LM
WATTS 20.62 W
CCT 3000K

Zone	Lumens	%Lamp	%Luminaire
0-30	1,409.1	85.5%	85.5%
0-40	1,555.7	94.4%	94.4%
0-60	1,631.4	99%	99%
60-90	16.3	1%	1%
0-90	1,647.7	100%	100%

RPA - 16L 60° BEAM

TEST DATE 2019-02-19
SERIES RPA6-16L-30K-60°-SFA
LUMENS 1556.2 LM
WATTS 20.62 W
CCT 3000K

Zone	Lumens	%Lamp	%Luminaire
0-30	1,152.9	74.1%	74.1%
0-40	1,414.0	90.9%	90.9%
0-60	1,531.9	98.4%	98.5%
60-90	24.0	1.5%	1.5%
0-90	1,555.9	100%	100%

RPA - 16L 80° BEAM

TEST DATE 2019-02-19
SERIES RPA6-16L-30K-80°-SFA
LUMENS 1484.4 LM
WATTS 20.64 W
CCT 3000K

Zone	Lumens	%Lamp	%Luminaire
0-30	853.4	57.5%	57.5%
0-40	1,221.5	82.3%	82.3%
0-60	1,441.6	97.1%	97.2%
60-90	41.8	2.8%	2.8%
0-90	1,483.4	99.9%	100%

RPA - 21L 18° BEAM

TEST DATE 2019-02-19
SERIES RPA6-21L-30K-18°-SFA
LUMENS 2043.2 LM
WATTS 29.52 W
CCT 3000K

Zone	Lumens	%Lamp	%Luminaire
0-30	1,679.8	82.2%	82.2%
0-40	1,854.8	90.8%	90.7%
0-60	2,012.4	98.5%	98.4%
60-90	32.2	1.6%	1.6%
0-90	2,044.6	100.1%	100%

RPA - 21L 30° BEAM

TEST DATE 2019-02-19
SERIES RPA6-21L-30K-30°-SFA
LUMENS 2143.4 LM
WATTS 29.52 W
CCT 3000K

Zone	Lumens	%Lamp	%Luminaire
0-30	1,829.0	85.3%	85.3%
0-40	2,021.5	94.3%	94.3%
0-60	2,122.2	99%	99%
60-90	22.0	1%	1%
0-90	2,144.1	100%	100%

RPA - 21L 60° BEAM

TEST DATE 2019-02-19
SERIES RPA6-21L-30K-60°-SFA
LUMENS 2033.2 LM
WATTS 29.54 W
CCT 3000K

Zone	Lumens	%Lamp	%Luminaire
0-30	1,504.2	74%	74%
0-40	1,845.7	90.8%	90.8%
0-60	2,000.8	98.4%	98.4%
60-90	32.0	1.6%	1.6%
0-90	2,032.8	100%	100%

RPA - 21L 80° BEAM

TEST DATE 2019-02-19
SERIES RPA6-21L-30K-80°-SFA
LUMENS 1952.3 LM
WATTS 29.60 W
CCT 3000K

Zone	Lumens	%Lamp	%Luminaire
0-30	1,120.6	57.4%	57.5%
0-40	1,604.9	82.2%	82.3%
0-60	1,894.2	97%	97.2%
60-90	55.5	2.8%	2.8%
0-90	1,949.6	99.9%	100%

[CLICK HERE OR VISIT PRODUCT PAGE FOR COMPREHENSIVE TECHNICAL INFORMATION](#)

PRIME

PRIME 6" LED ARCHITECTURAL
SQUARE FLANGED ADJUSTABLE

6" PRIME ADJUSTABLE

AT-A-GLANCE TECHNICAL INFORMATION

RPA - 25L 18° BEAM

TEST DATE 2019-02-19
SERIES RPA6-25L-30K-18°-SFA
LUMENS 2387.5 LM
WATTS 28.29 W
CCT 3000K

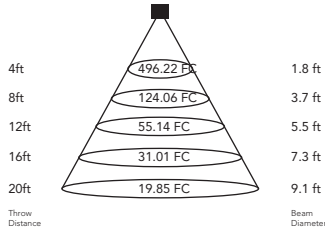

Zone	Lumens	%Lamp	%Luminaire
0-30	1,922.9	80.5%	80.5%
0-40	2,157.2	90.4%	90.3%
0-60	2,349.7	98.4%	98.4%
60-90	39.2	1.6%	1.6%
0-90	2,388.9	100.1%	100%

RPA - 25L 30° BEAM

TEST DATE 2019-02-19
SERIES RPA6-25L-30K-30°-SFA
LUMENS 2507.5 LM
WATTS 28.29 W
CCT 3000K

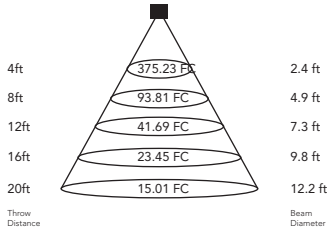

Zone	Lumens	%Lamp	%Luminaire
0-30	2,071.5	82.6%	82.6%
0-40	2,347.1	93.6%	93.5%
0-60	2,481.3	99%	99.9%
60-90	27.8	1.1%	1.1%
0-90	2,509.1	100.1%	100%

RPA - 25L 60° BEAM

TEST DATE 2019-02-19
SERIES RPA6-25L-30K-60°-SFA
LUMENS 2375.3 LM
WATTS 28.25 W
CCT 3000K

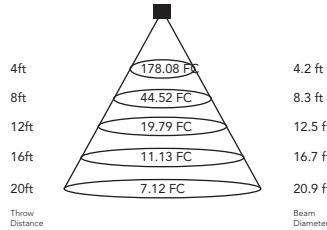

Zone	Lumens	%Lamp	%Luminaire
0-30	1,722.5	72.5%	72.5%
0-40	2,143.8	90.3%	90.3%
0-60	2,336.0	98.3%	98.4%
60-90	38.8	1.6%	1.6%
0-90	2,374.8	100%	100%

RPA - 25L 80° BEAM

TEST DATE 2019-02-19
SERIES RPA6-25L-30K-80°-SFA
LUMENS 2261.4 LM
WATTS 28.25 W
CCT 3000K

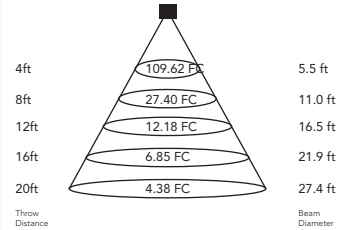

Zone	Lumens	%Lamp	%Luminaire
0-30	1,309.2	57.9%	58%
0-40	1,863.8	82.4%	82.5%
0-60	2,194.5	97%	97.2%
60-90	63.7	2.8%	2.8%
0-90	2,258.2	99.9%	100%

RPA - 31L 18° BEAM

TEST DATE 2019-02-19
SERIES RPA6-31L-30K-18°-SFA
LUMENS 2944.8 LM
WATTS 37.63 W
CCT 3000K

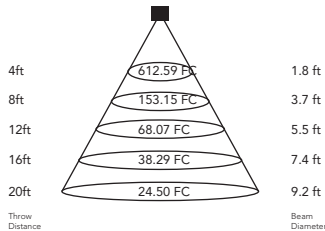

Zone	Lumens	%Lamp	%Luminaire
0-30	2,371.7	80.5%	80.5%
0-40	2,660.7	90.4%	90.3%
0-60	2,898.1	98.4%	98.3%
60-90	48.6	1.7%	1.7%
0-90	2,946.7	100.1%	100%

RPA - 31L 30° BEAM

TEST DATE 2019-02-19
SERIES RPA6-31L-30K-30°-SFA
LUMENS 3093.7 LM
WATTS 37.66 W
CCT 3000K

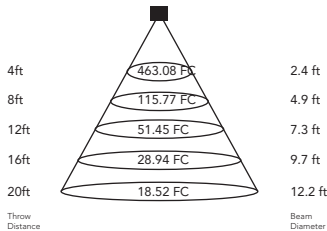

Zone	Lumens	%Lamp	%Luminaire
0-30	2,553.9	82.6%	82.5%
0-40	2,893.7	93.5%	93.5%
0-60	3,060.6	98.9%	98.9%
60-90	34.8	1.1%	1.1%
0-90	3,095.4	100.1%	100%

RPA - 31L 60° BEAM

TEST DATE 2019-02-19
SERIES RPA6-31L-30K-60°-SFA
LUMENS 2935.5 LM
WATTS 37.69 W
CCT 3000K

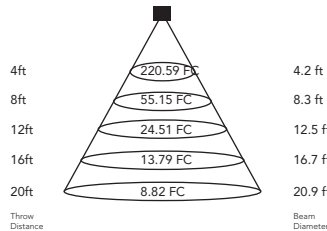

Zone	Lumens	%Lamp	%Luminaire
0-30	2,123.3	72.3%	72.4%
0-40	2,645.9	90.1%	90.2%
0-60	2,885.1	98.3%	98.4%
60-90	48.4	1.6%	1.6%
0-90	2,933.5	99.9%	100%

RPA - 31L 80° BEAM

TEST DATE 2019-02-19
SERIES RPA6-31L-30K-80°-SFA
LUMENS 2809 LM
WATTS 37.70 W
CCT 3000K

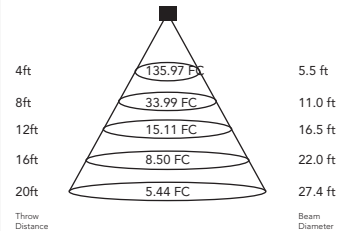

Zone	Lumens	%Lamp	%Luminaire
0-30	1,624.3	57.8%	57.9%
0-40	2,313.9	82.4%	82.5%
0-60	2,726.4	97.1%	97.2%
60-90	79.6	2.8%	2.8%
0-90	2,806.0	99.9%	100%

[CLICK HERE OR VISIT PRODUCT PAGE FOR COMPREHENSIVE TECHNICAL INFORMATION](#)

PRIME

PRIME 6" LED ARCHITECTURAL
SQUARE FLANGED ADJUSTABLE

6" PRIME ADJUSTABLE

AT-A-GLANCE TECHNICAL INFORMATION

RPA - 34L 18° BEAM

TEST DATE 2019-02-19
SERIES RPA6-34L-30K-18°-SFA
LUMENS 3304.8 LM
WATTS 44.71 W
CCT 3000K

Zone	Lumens	%Lamp	%Luminaire
0-30	2,654.0	80.3%	80.3%
0-40	2,981.8	90.2%	90.2%
0-60	3,250.2	98.3%	98.3%
60-90	55.1	1.7%	1.7%
0-90	3,305.3	100%	100%

Zone Lumen Summary

RPA - 34L 30° BEAM

TEST DATE 2019-02-19
SERIES RPA6-34L-30K-30°-SFA
LUMENS 3483.7 LM
WATTS 44.57 W
CCT 3000K

Zone	Lumens	%Lamp	%Luminaire
0-30	2,872.0	82.4%	82.4%
0-40	3,256.1	93.5%	93.5%
0-60	3,443.9	98.9%	98.9%
60-90	39.4	1.1%	1.1%
0-90	3,483.3	100.1%	100%

Zone Lumen Summary

RPA - 34L 60° BEAM

TEST DATE 2019-02-19
SERIES RPA6-34L-30K-60°-SFA
LUMENS 3290.5 LM
WATTS 44.68 W
CCT 3000K

Zone	Lumens	%Lamp	%Luminaire
0-30	2,385.4	72.5%	72.5%
0-40	2,968.8	90.2%	90.2%
0-60	3,235.0	98.3%	98.4%
60-90	54.6	1.7%	1.7%
0-90	3,289.6	100%	100%

Zone Lumen Summary

RPA - 34L 80° BEAM

TEST DATE 2019-02-19
SERIES RPA6-34L-30K-80°-SFA
LUMENS 3147 LM
WATTS 44.52 W
CCT 3000K

Zone	Lumens	%Lamp	%Luminaire
0-30	1,822.7	57.9%	58%
0-40	2,593.6	82.4%	82.5%
0-60	3,055.3	97.1%	97.2%
60-90	89.0	2.8%	2.8%
0-90	3,144.3	99.9%	100%

Zone Lumen Summary

RPA - 40L 18° BEAM

TEST DATE 2019-02-19
SERIES RPA6-40L-30K-18°-SFA
LUMENS 3849 LM
WATTS 57.96 W
CCT 3000K

Zone	Lumens	%Lamp	%Luminaire
0-30	2,860.5	74.3%	74.3%
0-40	3,393.4	88.2%	88.2%
0-60	3,773.4	98%	98%
60-90	75.4	2%	2%
0-90	3,848.8	100%	100%

Zone Lumen Summary

RPA - 40L 30° BEAM

TEST DATE 2019-02-19
SERIES RPA6-40L-30K-30°-SFA
LUMENS 4042.9 LM
WATTS 57.98 W
CCT 3000K

Zone	Lumens	%Lamp	%Luminaire
0-30	3,052.8	75.5%	75.5%
0-40	3,665.0	90.7%	90.6%
0-60	3,983.5	98.5%	98.5%
60-90	61.2	1.5%	1.5%
0-90	4,044.7	100.1%	100%

Zone Lumen Summary

RPA - 40L 60° BEAM

TEST DATE 2019-02-19
SERIES RPA6-40L-30K-60°-SFA
LUMENS 3821.2 LM
WATTS 57.98 W
CCT 3000K

Zone	Lumens	%Lamp	%Luminaire
0-30	2,600.3	68.1%	68.1%
0-40	3,355.9	87.8%	87.9%
0-60	3,744.7	98%	98%
60-90	75.2	2%	2%
0-90	3,819.9	100%	100%

Zone Lumen Summary

RPA - 40L 80° BEAM

TEST DATE 2019-02-19
SERIES RPA6-40L-30K-80°-SFA
LUMENS 3731.3 LM
WATTS 57.97 W
CCT 3000K

Zone	Lumens	%Lamp	%Luminaire
0-30	2,166.6	58.1%	58.1%
0-40	3,064.9	82.1%	82.2%
0-60	3,621.3	97.1%	97.1%
60-90	107.3	2.9%	2.9%
0-90	3,728.6	99.9%	100%

Zone Lumen Summary

[CLICK HERE OR VISIT PRODUCT PAGE FOR COMPREHENSIVE TECHNICAL INFORMATION](#)