

# PRIME

3" PRIME SUPER SHALLOW LED ARCHITECTURAL ROUND FLANGELESS DOWNLIGHT

|                 |               |
|-----------------|---------------|
| JOB INFORMATION | TYPE:         |
|                 | CATALOG NO.   |
|                 | PROJECT NAME: |
|                 | COMMENTS:     |
| PREPARED BY:    |               |

### USE OF PRODUCT

The 3" PRIME Downlight is a small aperture fixture with shallow height that may be used in residential and commercial applications. Die cast trims with an assortment of color temperatures, optics and dimmable drivers. May be used in plaster, wood and marble ceilings.

### PRIME FEATURES

Color Temperature: 2700K, 3000K, 3500K, or 4000K  
 SDCM: 2 step binning  
 Color Rendering Index: 93+ CRI  
 Optical Lens: 12°, 22°, 27°, 35°, 45°  
 Trim: Die cast  
 LED Life: 50,000 Hours  
 LED Type: Cree LED  
 Driver Info: 120-277V, 50/60 Hz, PF>0.9, THD<0.20  
 Warranty: 5 year limited warranty

### LED ENGINE

LED engine available with CREE LEDs in 2700K, 3000K, 3500K, or 4000K in standard 93+ CRI. 2 Step MacAdam ellipse allows for color consistency between fixtures. LED mounted to aluminum heat sink for maximum life output and thermal management. LED engine is accessible from below ceiling.

### FRAME CONSTRUCTION

IC rated housing constructed from 16 gauge heavy duty powder coated cold rolled steel frame. Junction box with 1/2" knockouts. Trimless Mud adapter plate available for plaster ceilings. Millwork adapter available for marble or wood ceilings. Butterfly bracket included to accommodate adjustable bar hangers or C-channel (ordered separately)

### ADJUSTMENT

- Housing provides for 359° locking rotation  
 - Aperture collar compatible up to 1½" ceiling thickness.  
 - Accommodation for 2" or 3" ceiling thickness available upon request.

### OPTICAL LENS & FILTERS (Field Replaceable)

Field replaceable optical lens available in 12°, 22°, 27°, 35° and 45°. Easily achieve narrow spot to wide flood beam pattern. Accepts up to 2 filters.

### DIMMING

Available in 2 driver selections. **(ID)** Standard all-inclusive ELV(120V), Triac(120V), and 0-10V(120-277V) dimming driver called Intelligent Drive, 120-277V. **(PEQ0)** Lutron Hi-Lume Premier Ecosystem 0.1% w/soft on, fade to black dimming, 120-277V.

### THERMAL MANAGEMENT

Ambient temperatures at fixture location should not exceed -20° to 40°C.

### TRIM

Trim available in die cast or spun aluminum. Consult factory for made to order finishes. Flanged trim is compatible with all ceiling materials.

### EMERGENCY BATTERY

Optional emergency battery available for a minimum of 90 minutes with Remote test switch in 800 delivered lumens.

### LABELS/COMPLIANCE/WARRANTY

- CSA Listed for US and Canada  
 - Dry/Damp/Wet location rated.  
 - Energy Star  
 - Title 24, JA8 Compliant  
 - 5 Year limited warranty



### ORDERING INFO

| RPA3S         |              |            |                |  |              |                           |
|---------------|--------------|------------|----------------|--|--------------|---------------------------|
| Series        | Lumens       | Color Temp | Voltage        | Dimming  | Optical Lens | Filter                    |
| <b>PRIME</b>  | 8 - 890 lm   | 27 - 2700K | UNV - 120-277V | ID <sup>1</sup> - Standard all-inclusive ELV, Triac, and 0-10V dimming driver (Intelligent Drive)<br>PEQ0 - Lutron Hi-lume Premier Ecosystem 0.1% w/soft on, fade to black dimming | 12 - 12°     | <b>None</b> - Leave blank |
| <b>SERIES</b> | 11 - 1175 lm | 30 - 3000K | 120 - 120V     |  | 22 - 22°     | F - Frosted               |
|               | 16 - 1650 lm | 35 - 3500K | 347 - 347V     |  | 27 - 27°     | H - Honeycomb             |
|               |              | 40 - 4000K |                |  | 35 - 35°     | S - Solite filter         |
|               |              |            |                |  | 45 - 45°     | L - Linear filter         |

| Housing Type                           | Aperture  | Frame Accessories   | Collar  | Option  |
|--|---|---|---|---|
| IC - IC Super Shallow New Construction | RLDP - Round Flangeless Downlight Plaster<br>RLDM - Round Flangeless Downlight Millwork | AH - Adjustable bar hanger<br>C - C Channel bar hanger<br>B - Flat bar hanger | Blank - 1.5" Depth<br>20 - 2" Depth<br>30 - 3" Depth<br>MTO - Made to order | ER6 <sup>2</sup> - Emergency battery with remote switch (800 Lumens)<br>CP - Chicago Plenum |

### TRIM ORDERING INFORMATION

| Aperture Size / Shape / Trim Type / Style | Bevel Opening  | Bevel Finish  | Options           |
|---|--|---|-------------------|
| 3RLO - 3" Round Flangeless Open           | Die Cast   |   |                   |
|   | CL - Die cast large opening<br>CS - Die cast small opening | W - White<br>B - Black<br>H - Haze<br>BZ - Bronze<br>C - Clear<br>MTO - Made to order | WL - Wet location |

1. Intelligent Drive is the standard driver.  
 2. Ceiling access required.  
 3. Must specify logarithmic or linear eldoLED diver.

# PRIME

3" PRIME SUPER SHALLOW LED ARCHITECTURAL ROUND FLANGELESS DOWNLIGHT

3" PRIME DOWNLIGHT

## DIMENSIONS

IC Housing

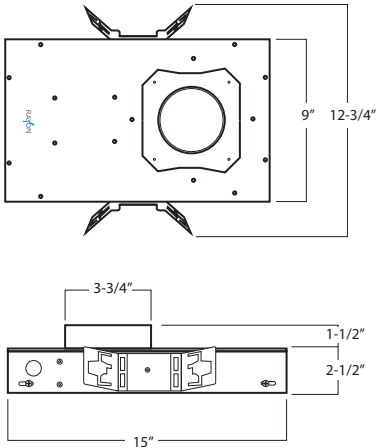

Heatsink



LED Holder (Body)



Optics

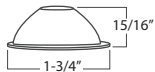

Filter



LED Holder (Head)

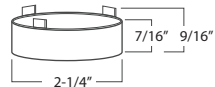

Trim

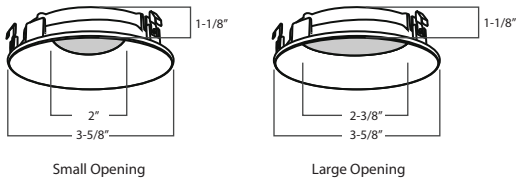

## FRAME ACCESSORIES

B

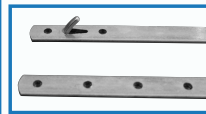

Flat Bar Hanger

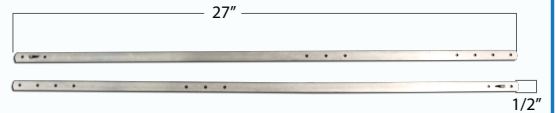

C



C Channel Bar Hanger

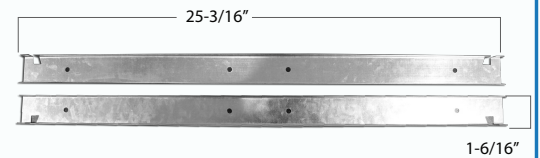

AH

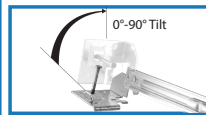

C Channel Bar Hanger

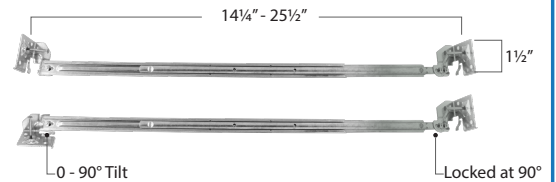

## COLLAR DEPTH PER CEILING THICKNESS

