

PRIME

PRIME 3" SUPER SHALLOW LED ARCHITECTURAL SQUARE FLANGED DOWNLIGHT

JOB INFORMATION	TYPE:
	CATALOG NO.
	PROJECT NAME:
	COMMENTS:
	PREPARED BY:

USE OF PRODUCT

The 3" PRIME Downlight is a small aperture fixture with shallow height that may be used in residential and commercial applications. Available with die cast or spun aluminum trims, with an assortment of color temperatures, optics and dimmable drivers.

PRIME FEATURES

Color Temperature: 2700K, 3000K, 3500K, or 4000K
 SDCM: 2 step binning
 Color Rendering Index: 93+ CRI
 Optical Lens: 12°, 22°, 27°, 35°, 45°
 Trim: Die cast or spun aluminum
 LED Life: 50,000 Hours
 LED Type: Cree LED
 Driver Info: 120-277V, 50/60 Hz, PF>0.9, THD<0.20
 Warranty: 5 year limited warranty

LED ENGINE

LED engine available with CREE LEDs in 2700K, 3000K, 3500K, or 4000K in standard 93+ CRI. 2 Step MacAdam ellipse allows for color consistency between fixtures. LED mounted to aluminum heat sink for maximum life output and thermal management. LED engine is accessible from below ceiling.

FRAME CONSTRUCTION

IC rated housing constructed from 16 gauge heavy duty powder coated cold rolled steel frame. Junction box with 1/2" knockouts. Butterfly bracket included to accommodate adjustable bar hangers or C-channel (ordered separately).

ADJUSTMENT

- Housing provides for 359° locking rotation
 - Aperture collar compatible up to 1½" ceiling thickness.
 - Accommodation for 2" or 3" ceiling thickness available upon request.

OPTICAL LENS & FILTERS (Field Replaceable)

Field replaceable optical lens available in 12°, 22°, 27°, 35° and 45°. Easily achieve narrow spot to wide flood beam pattern. Accepts up to 2 filters.

DIMMING

Available in 2 driver selections. **(ID)** Standard all-inclusive ELV(120V), Triac(120V), and 0-10V(120-277V) dimming driver called Intelligent Drive, 120-277V. **(PEQ0)** Lutron Hi-Lume Premier Ecosystem 0.1% w/soft on, fade to black dimming, 120-277V.

THERMAL MANAGEMENT

Ambient temperatures at fixture location should not exceed -20° to 40°C.

TRIM

Trim available in die cast or spun aluminum. Consult factory for made to order finishes. Flanged trim is compatible with all ceiling materials.

EMERGENCY BATTERY

Optional emergency battery available for a minimum of 90 minutes with remote test switch in 800 delivered lumens.

LABELS/COMPLIANCE/WARRANTY

- CSA Listed for US and Canada
 - Energy Star
 - Dry/Damp/Wet location rated.
 - Title 24, JA8 Compliant
 - 5 Year limited warranty.



ORDERING INFO

RPA3S						
Series	Lumens	Color Temp	Voltage	Dimming	Optical Lens	Filter
PRIME SERIES	8 - 890 lm 11 - 1175 lm 16 - 1650 lm	27 - 2700K 30 - 3000K 35 - 3500K 40 - 4000K	UNV - 120-277V 120 - 120V 347 - 347V	ID ¹ - Standard all-inclusive ELV, Triac, and 0-10V dimming driver (Intelligent Drive) PEQ0 - Lutron Hi-lume Premier Ecosystem 0.1% w/soft on, fade to black dimming	12 - 12° 22 - 22° 27 - 27° 35 - 35° 45 - 45°	None - Leave blank F - Frosted H - Honeycomb S - Solite L - Linear

SFD				
Housing Type	Aperture	Frame Accessories	Collar	Option
IC - IC Super Shallow New Construction	SFD - Square Flanged Downlight	AH - Adjustable bar hanger C - C Channel bar hanger B - Flat bar hanger	Blank - 1.5" Depth 20 - 2" Depth 30 - 3" Depth MTO - Made to order	ER8 ³ - Emergency battery with remote switch (800 Lumens) CP - Chicago Plenum

1. Intelligent Drive is the standard driver.
 2. Ceiling access required.
 3. Must specify logarithmic or linear eldoLED driver.

TRIM ORDERING INFORMATION

3SFO - 3" Square Flange Open				
Aperture Size / Shape / Trim Type / Style	Bevel Opening	Bevel	Flange	Options
	Die Cast			WL - Wet location
	CL - Die cast large opening CS - Die cast small opening	W - White H - Haze B - Black BZ - Bronze C - Clear MTO - Made to order	W - White B - Black BZ - Bronze MTO - Made to order	

PRIME

PRIME 3" SUPER SHALLOW LED ARCHITECTURAL SQUARE FLANGED DOWNLIGHT

DIMENSIONS

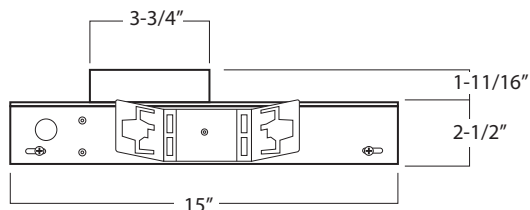
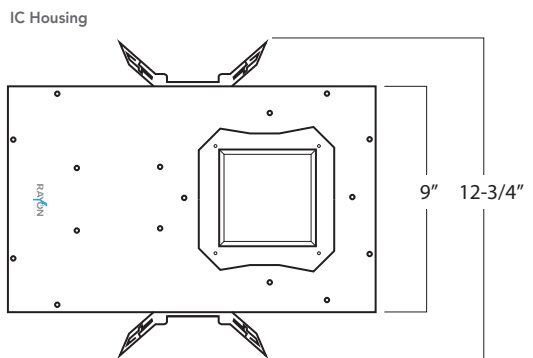

Heatsink



LED Holder (Body)

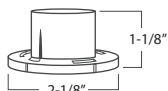

Optics

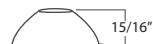

Filter

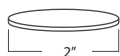

LED Holder (Head)

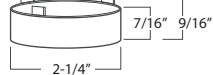

Trim

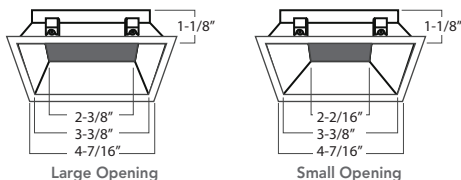

TRIM THICKNESS

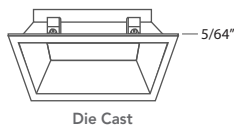

FRAME ACCESSORIES

B

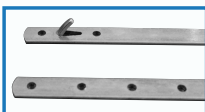

Flat Bar Hanger



C



C Channel Bar Hanger

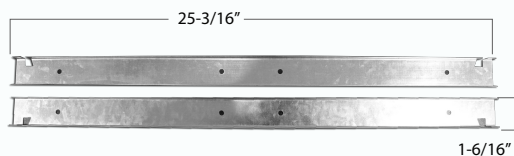

AH

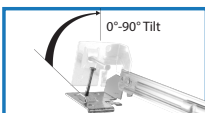

C Channel Bar Hanger

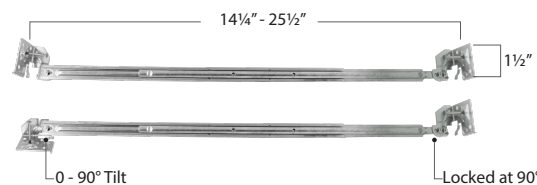

COLLAR DEPTH PER CEILING THICKNESS

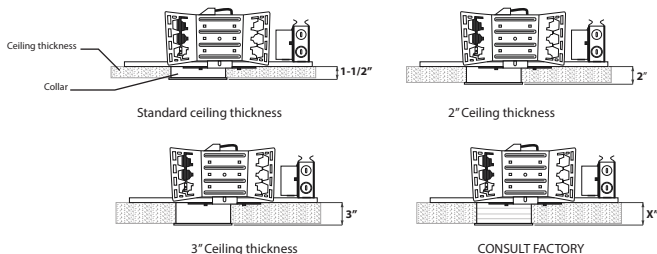

PRIME

PRIME 3" SUPER SHALLOW LED ARCHITECTURAL SQUARE FLANGED DOWNLIGHT

3" PRIME DOWNLIGHT

AT-A-GLANCE TECHNICAL INFORMATION

RPA - 8L

12° Beam, Square Large Open

TEST DATE	2019-07-12
SERIES	RPA3-8L-30K-12°- Square Large Open
LUMENS	786.4 LM
WATTS	10 W
CCT	3000K

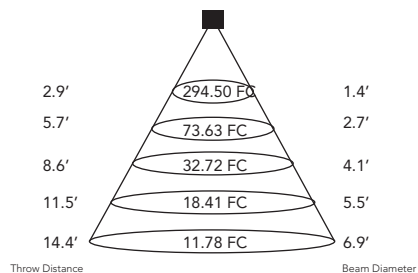

Zone	Lumens	%Lamp	%Luminaire
0-30	699.2	88.9%	88.8%
0-40	741.2	94.3%	94.1%
0-60	780.8	99.3%	99.1%
60-90	7.0	0.9%	0.9%
0-90	787.8	100.2%	100%

Zone Lumen Summary

RPA - 8L

22° Beam, Square Large Open

TEST DATE	2019-07-12
SERIES	RPA3-8L-30K-22°- Square Large Open
LUMENS	794 LM
WATTS	10 W
CCT	3000K

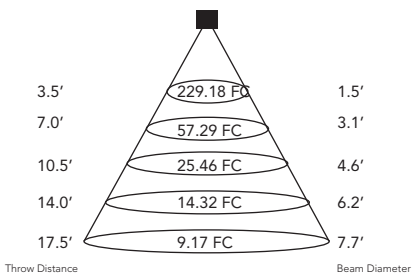

Zone	Lumens	%Lamp	%Luminaire
0-30	691.7	87.1%	87%
0-40	749.6	94.4%	94.3%
0-60	788.3	99.3%	99.2%
60-90	6.6	0.8%	0.8%
0-90	794.9	100.1%	100%

Zone Lumen Summary

RPA - 8L

27° Beam, Square Large Open

TEST DATE	2019-07-12
SERIES	RPA3-8L-30K-27°- Square Large Open
LUMENS	816.2 LM
WATTS	10 W
CCT	3000K

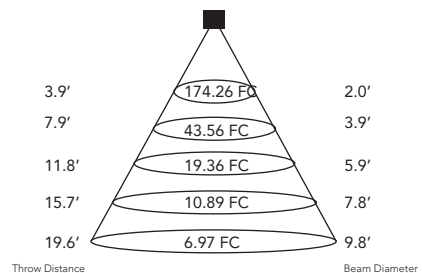

Zone	Lumens	%Lamp	%Luminaire
0-30	775.4	89.9%	89.9%
0-40	828.3	96.1%	96%
0-60	858.2	99.5%	99.5%
60-90	4.7	0.5%	0.5%
0-90	862.9	100.1%	100%

Zone Lumen Summary

RPA - 8L

35° Beam, Square Large Open

TEST DATE	2019-07-12
SERIES	RPA3-8L-30K-35°- Square Large Open
LUMENS	827.2 LM
WATTS	10 W
CCT	3000K

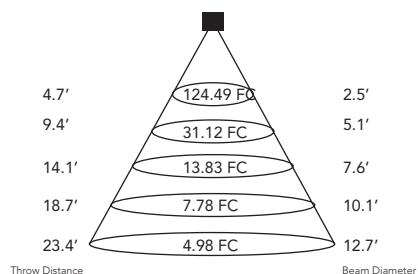

Zone	Lumens	%Lamp	%Luminaire
0-30	706.6	85.4%	85.5%
0-40	779.8	94.3%	94.3%
0-60	821.5	99.3%	99.4%
60-90	5.3	0.6%	0.6%
0-90	826.8	100%	100%

Zone Lumen Summary

RPA - 8L

45° Beam, Square Large Open

TEST DATE	2019-07-12
SERIES	RPA3-8L-30K-45°- Square Large Open
LUMENS	800.8 LM
WATTS	10 W
CCT	3000K

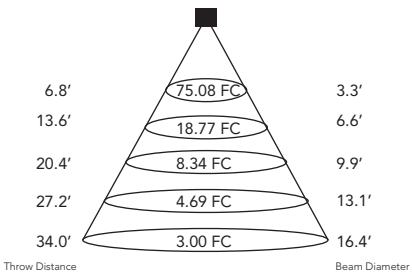

Zone	Lumens	%Lamp	%Luminaire
0-30	565.0	70.6%	70.6%
0-40	709.2	88.6%	88.6%
0-60	793.7	99.1%	99.2%
60-90	6.7	0.8%	0.8%
0-90	800.5	100%	100%

Zone Lumen Summary

AT-A-GLANCE TECHNICAL INFORMATION

RPA - 15L

12° Beam, Square Large Open

TEST DATE	2019-07-12
SERIES	RPA3-15L-30K-12°- Square Large Open
LUMENS	1410 LM
WATTS	20 W
CCT	3000K

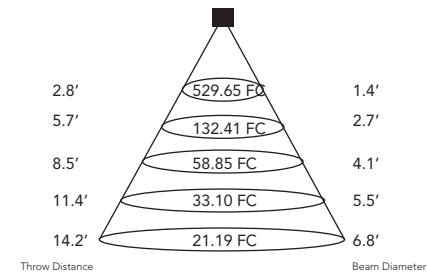

Zone	Lumens	%Lamp	%Luminaire
0-30	1,253.1	88.9%	88.7%
0-40	1,327.7	94.2%	94%
0-60	1,398.8	99.2%	99.1%
60-90	13.3	0.9%	0.9%
0-90	1,412.2	100.2%	100%

Zone Lumen Summary

RPA - 15L

22° Beam, Square Large Open

TEST DATE	2019-07-12
SERIES	RPA3-15L-30K-22°- Square Large Open
LUMENS	1422 LM
WATTS	20 W
CCT	3000K

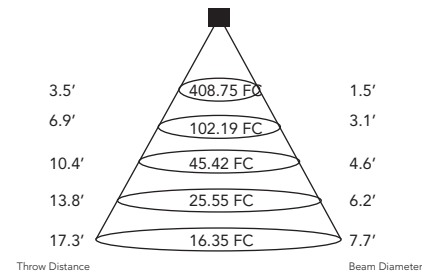

Zone	Lumens	%Lamp	%Luminaire
0-30	1,235.7	86.9%	86.8%
0-40	1,340.5	94.3%	94.2%
0-60	1,410.9	99.2%	99.1%
60-90	12.7	0.9%	0.9%
0-90	1,423.6	100.1%	100%

Zone Lumen Summary

RPA - 15L

27° Beam, Square Large Open

TEST DATE	2019-07-12
SERIES	RPA3-15L-30K-27°- Square Large Open
LUMENS	1462.7 LM
WATTS	20 W
CCT	3000K

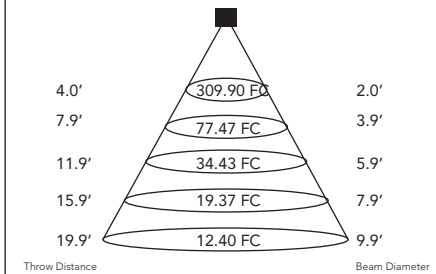

Zone	Lumens	%Lamp	%Luminaire
0-30	1,263.5	86.4%	86.4%
0-40	1,377.9	94.2%	94.2%
0-60	1,450.7	99.2%	99.2%
60-90	12.0	0.8%	0.8%
0-90	1,462.7	100%	100%

Zone Lumen Summary

RPA - 15L

35° Beam, Square Large Open

TEST DATE	2019-07-12
SERIES	RPA3-15L-30K-35°- Square Large Open
LUMENS	1495 LM
WATTS	20 W
CCT	3000K

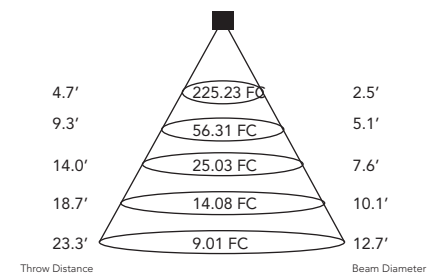

Zone	Lumens	%Lamp	%Luminaire
0-30	1,278.6	85.5%	85.5%
0-40	1,409.4	94.3%	94.3%
0-60	1,484.4	99.3%	99.3%
60-90	10.5	0.7%	0.7%
0-90	1,494.9	100%	100%

Zone Lumen Summary

RPA - 15L

45° Beam, Square Large Open

TEST DATE	2019-07-12
SERIES	RPA3-15L-30K-45°- Square Large Open
LUMENS	1457.1 LM
WATTS	20 W
CCT	3000K

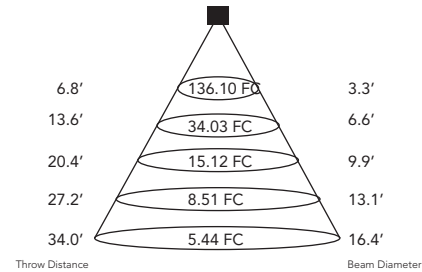

Zone	Lumens	%Lamp	%Luminaire
0-30	1,025.8	70.4%	70.4%
0-40	1,288.3	88.4%	88.4%
0-60	1,443.3	99%	99.1%
60-90	13.2	0.9%	0.9%
0-90	1,456.5	100%	100%

Zone Lumen Summary

PRIME

PRIME 3" SUPER SHALLOW LED ARCHITECTURAL SQUARE FLANGED DOWNLIGHT

3" PRIME DOWNLIGHT

AT-A-GLANCE TECHNICAL INFORMATION

RPA - 12L

12° Beam, Square Small Open

TEST DATE	2019-07-12
SERIES	RPA3-12L-30K-12°- Square Small Open
LUMENS	1169.4 LM
WATTS	14 W
CCT	3000K

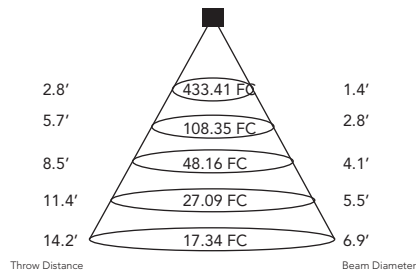

Zone	Lumens	%Lamp	%Luminaire
0-30	1,033.9	88.4%	88.3%
0-40	1,095.9	93.7%	93.6%
0-60	1,157.1	98.9%	98.8%
60-90	14.2	1.2%	1.2%
0-90	1,171.3	100.2%	100%

Zone Lumen Summary

RPA - 12L

22° Beam, Square Small Open

TEST DATE	2019-07-12
SERIES	RPA3-12L-30K-22°- Square Small Open
LUMENS	1176.9 LM
WATTS	14 W
CCT	3000K

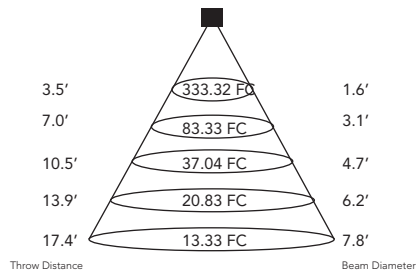

Zone	Lumens	%Lamp	%Luminaire
0-30	1,019.7	86.6%	86.5%
0-40	1,104.4	93.8%	93.7%
0-60	1,164.4	98.9%	98.8%
60-90	13.9	1.2%	1.2%
0-90	1,178.3	100.1%	100%

Zone Lumen Summary

RPA - 12L

27° Beam, Square Small Open

TEST DATE	2019-07-12
SERIES	RPA3-12L-30K-27°- Square Small Open
LUMENS	1213.9 LM
WATTS	14 W
CCT	3000K

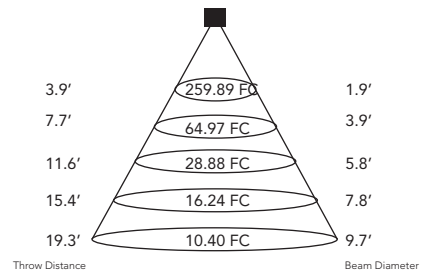

Zone	Lumens	%Lamp	%Luminaire
0-30	1,053.2	86.8%	86.7%
0-40	1,142.7	94.1%	94.1%
0-60	1,202.1	99%	99%
60-90	12.5	1%	1%
0-90	1,214.6	100.1%	100%

Zone Lumen Summary

RPA - 12L

35° Beam, Square Small Open

TEST DATE	2019-07-12
SERIES	RPA3-12L-30K-35°- Square Small Open
LUMENS	1237.7 LM
WATTS	14 W
CCT	3000K

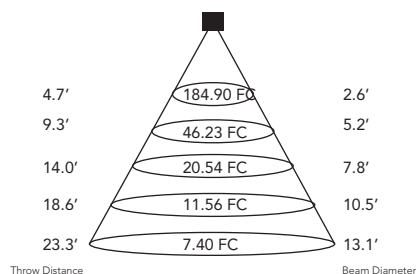

Zone	Lumens	%Lamp	%Luminaire
0-30	1,056.7	85.4%	85.4%
0-40	1,163.9	94%	94%
0-60	1,227.2	99.1%	99.1%
60-90	10.7	0.9%	0.9%
0-90	1,237.9	100%	100%

Zone Lumen Summary

RPA - 12L

45° Beam, Square Small Open

TEST DATE	2019-07-12
SERIES	RPA3-12L-30K-45°- Square Small Open
LUMENS	1213 LM
WATTS	14 W
CCT	3000K

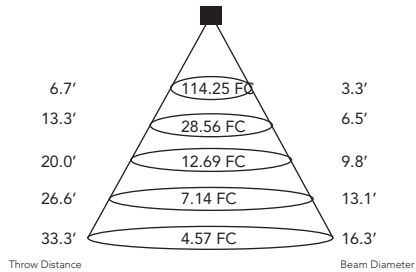

Zone	Lumens	%Lamp	%Luminaire
0-30	858.7	70.8%	70.8%
0-40	1,075.3	88.7%	88.7%
0-60	1,200.4	99%	99%
60-90	12.4	1%	1%
0-90	1,212.8	100%	100%

Zone Lumen Summary

PRIME

PRIME 3" SUPER SHALLOW LED ARCHITECTURAL SQUARE FLANGED DOWNLIGHT

3" PRIME DOWNLIGHT

AT-A-GLANCE TECHNICAL INFORMATION

RPA - 15L

12° Beam, Square Small Open

TEST DATE	2019-07-12
SERIES	RPA3-15L-30K-12°- Square Small Open
LUMENS	1435.9 LM
WATTS	20 W
CCT	3000K

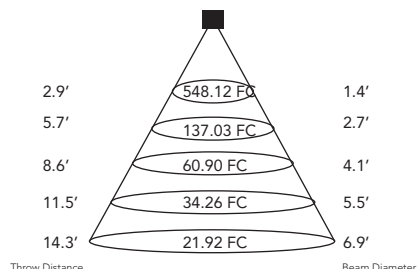

Zone	Lumens	%Lamp	%Luminaire
0-30	1,276.6	88.9%	88.7%
0-40	1,351.5	94.1%	93.9%
0-60	1,424.3	99.2%	99%
60-90	14.2	1%	1%
0-90	1,438.5	100.2%	100%

Zone Lumen Summary

RPA - 15L

22° Beam, Square Small Open

TEST DATE	2019-07-12
SERIES	RPA3-15L-30K-22°- Square Small Open
LUMENS	1463.8 LM
WATTS	20 W
CCT	3000K

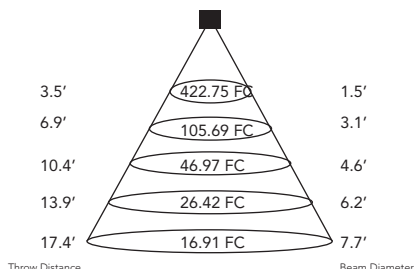

Zone	Lumens	%Lamp	%Luminaire
0-30	1,272.9	87%	86.9%
0-40	1,376.9	94.1%	94%
0-60	1,451.0	99.1%	99%
60-90	14.5	1%	1%
0-90	1,465.5	100.1%	100%

Zone Lumen Summary

RPA - 15L

27° Beam, Square Small Open

TEST DATE	2019-07-12
SERIES	RPA3-15L-30K-27°- Square Small Open
LUMENS	1491.3 LM
WATTS	20 W
CCT	3000K

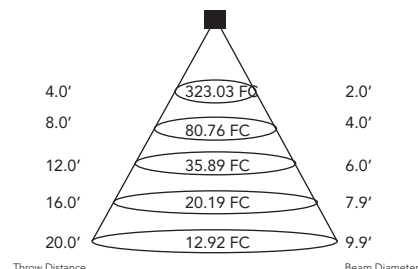

Zone	Lumens	%Lamp	%Luminaire
0-30	1,300.8	87.2%	87.2%
0-40	1,408.5	94.4%	94.4%
0-60	1,479.7	99.2%	99.2%
60-90	12.7	0.8%	0.8%
0-90	1,492.3	100.1%	100%

Zone Lumen Summary

RPA - 15L

35° Beam, Square Small Open

TEST DATE	2019-07-12
SERIES	RPA3-15L-30K-35°- Square Small Open
LUMENS	1506.2 LM
WATTS	20 W
CCT	3000K

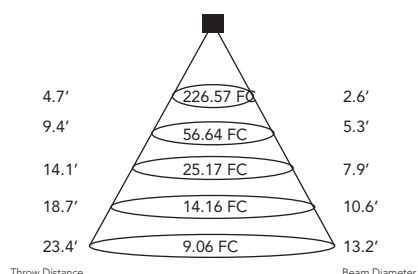

Zone	Lumens	%Lamp	%Luminaire
0-30	1,290.4	85.7%	85.7%
0-40	1,420.0	94.3%	94.3%
0-60	1,495.1	99.3%	99.3%
60-90	11.0	0.7%	0.7%
0-90	1,506.1	100%	100%

Zone Lumen Summary

RPA - 15L

45° Beam, Square Small Open

TEST DATE	2019-07-12
SERIES	RPA3-15L-30K-45°- Square Small Open
LUMENS	1461.3 LM
WATTS	20 W
CCT	3000K

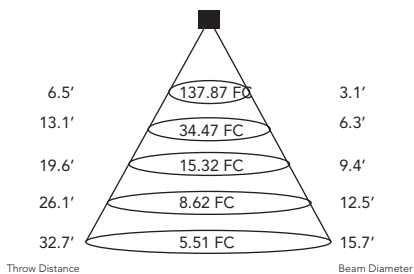

Zone	Lumens	%Lamp	%Luminaire
0-30	1,036.8	70.9%	71%
0-40	1,297.5	88.8%	88.8%
0-60	1,448.0	99.1%	99.1%
60-90	13.2	0.9%	0.9%
0-90	1,461.2	100%	100%

Zone Lumen Summary