

LTR-4RW-RFH Open SpectraSync

LITEISTRY 4" ROUND OPEN WALL WASH (WW/DWW) WITH COLOR TUNING

LITEISTRY™

FEATURES

- 4" architectural LED wall wash delivering 600–1500 lm
- Single and double wall wash solutions
- Provides uniform vertical illumination as well as room side light
- Quiet reflector appearance with 50° optical cutoff
- SpectraSync™ Color Tuning technology allows the flexibility to tailor CCT to aesthetic preferences
- Available in Dim to Warm (2200K-3000K) or Tunable White (2700K-5000K or 2700K-6500K), 90+ CRI
- Available in Retrofit (non-IC) applications
- Standard with 0-10V dimming to 5%



RELATED PRODUCTS

Ø 3" LITEISTRY Family

Ø 4" LITEISTRY Family

Ø 6" LITEISTRY Family



CONTROL TECHNOLOGY



SPECIFICATIONS

CONSTRUCTION

- Die cast aluminum mounting ring with 5 axis adjustable junction box
- Retrofit housing allows below ceiling installation without removing the existing fixture
- Pre-wired junction box with snap-on covers for easy access
- Snap-in connection from driver compartment allows easy installation
- Light Engine connections use plenum rated (CMP) cable

OPTICS

- Visually pleasing 50° cutoff to source and source image
- Open cone and kicker reflector assembly with an optical grade silicone lens integral to light engine
- Available in single and double wall wash distribution
- Provides excellent uniformity down the wall while also contributing to room side lighting
- The light distribution is free of distracting bright spots or pixelation and the perimeter has a smooth transition
- High purity spun aluminum reflector, self-flanged

OPTICS (CONTINUED)

- Large selection of anodized finishes and colors
- Painted cones and flange options available

ELECTRICAL

- LED array with 3 SDCM color consistency
- Dim to Warm (2200K-3000K) or Tunable White (2700K-5000K or 2700K-6500K) options available
- 90+ CRI standard
- Long LED life: L70 at >60,000 (TM-21)
- Universal voltage 120V–277V driver
- UL Class 2, inherent short circuit and overload protection, RoHS compliant
- Flicker free 0–10V dimming to 5%
- Refer to additional spec sheets for information on [standard LITEISTRY](#) or [PowerHUBB™ PoE enabled](#) solutions

INSTALLATION

- Accommodates ceiling thickness up to 2"
- Light engine/driver fully serviceable from above or below the ceiling

CERTIFICATIONS

- cCSAus certified to UL 1598
- Suitable for damp locations
- Approved for 8 (4 in/4 out) No. 12AWG conductors rated for 90°C through wiring
- This product qualifies as a “designated country construction material” per FAR 52.225-11 Buy American-Construction. Materials under Trade Agreements effective 6/6/2020. See [Buy American Solutions](#).

WARRANTY

- 5 year warranty
- See [HLI Standard Warranty](#) for additional information

KEY DATA	
Lumen Range	600-1500
Wattage Range	10-25
Efficacy Range (LPW)	56*
Reported Life (Hours)	L70 / >60,000
Input Current (mA)	83-208 (120V)

*Based on Specular, 30K, 90 CRI

LTR-4RW-RFH Open SpectraSync

LITEISTRY 4" ROUND OPEN WALL WASH (WW/DWW) WITH COLOR TUNING

ORDERING GUIDE

Example: LTR-4RD-RFH-SL10L-DMTW-LTR-4RW-T-SL2230TD9WW-S

CATALOG #

HOUSING

LTR-4RD-RFH		Lumen Package		Lumen Output		Driver Options		Voltage	Housing Options	
Aperture/Shape/Function										
LTR-4RD-RFH	4" Round Downlight/ WW/ DWW Wall Wash Retrofit Housing ⁵	SL	Standard Lumen	06L	600	DMTW	SpectraSync™ Dim to Warm, 0-10V Dimming to 5% ¹	Standard 120-277V	F	Fuse
				10L	1000					
LTR-4RD-RFHW	4" Round Downlight/WW/ DWW Retrofit Housing (for Wide Diameter) ⁵	ML	Medium Lumen	15L	1500	DMT	SpectraSync™ Tunable White, 0-10V Dimming to 5% ²			

TRIM

LTR-4RW-T		Lumen Package		CCT	CRI	Distribution		
Aperture/Shape/Function								
LTR-4RW-T	4" Round Wall Wash Light Engine/Trim Assembly	SL	Standard Lumen	2230TD	90+CRI	WW	Single Wall Wash	
		ML	Medium Lumen	2750T				2200K-3000K SpectraSync™ Dim to Warm
				2765T				2700K-5000K SpectraSync™ Tunable White
						DWW	Double Wall Wash	

TRIM CONTINUED

Reflector Finish	Reflector Color	Flange Color Options	Lower Trim Options	Reflector Options
<i>Finish not applicable with painted reflectors (WC or BC)</i>	<i>Standard Clear</i>	<i>Standard matches reflector color</i>	WF Wide Flange	AM Antimicrobial Coating ⁴
S Specular	CG Champagne Gold	WT White Flange ³		
SS Semi-Specular	BL Black	BT Black Flange ³		
MFC American Matte™	LW Light Wheat			
VS Softglow®	PW Pewter			
VSS SoftSheen™	WC Painted White Cone and Flange			
	BC Painted Black Cone and Flange			

Accessories	
<input type="checkbox"/> LiteGear	LiteGear® Inverter, 125VA-250VA
<input type="checkbox"/> LPS Series	LightPower Micro-Inverter, 20VA-55VA
<input type="checkbox"/> MOR4-R-WH	Metal Oversized Ring, 4" Round, White (8.25" outside diameter)
<input type="checkbox"/> MOR4-R-BL	Metal Oversized Ring, 4" Round, Black (8.25" outside diameter)

Notes:

- 1 Must select 2230TD with DMTW driver.
- 2 Must select either 2750T or 2765T with DMT driver.
- 3 WT not needed for WC, BT not needed for BC.
- 4 AM available with WC or Specular Clear (S or SWT). Consult factory for other colors.
- 5 See line art for compatibility with existing aperture diameters.

LTR-4RW-RFH Open SpectraSync

LITEISTRY 4" ROUND OPEN WALL WASH (WW/DWW) WITH COLOR TUNING

CONTROLS

SpectraSync™ Color Tuning Technology:

Control your space based on the needs of the application, specific activities throughout the day and preferences of the occupants with distinct SpectraSync™ Color Tuning Technologies.



SPECTRASYNCH COLOR TUNING TECHNOLOGY		
Mode	Kelvin Range	Description
Dim to Warm	2200K-3000K	Mimics the familiar warming effect that occurs with traditional incandescent sources as they are dimmed
Tunable White	2700K-5000K 2700K-6500K	Offers users the ability to tailor CCT to their personal preference, enhancing task visibility, material and colors or the aesthetics of the space
Scheduled White	2700K-5000K 2700K-6500K	Mimics the rhythm of natural light or follows an alternative user-defined schedule throughout the day, enhancing an occupant's mood and well-being

SpectraSync Tunable White

Available in two options: 2750T (2700K–5000K) or 2765T (2700K–6500K). Requires two 0–10V controllers, one for intensity and one for CCT. Minimum 5% dimming.

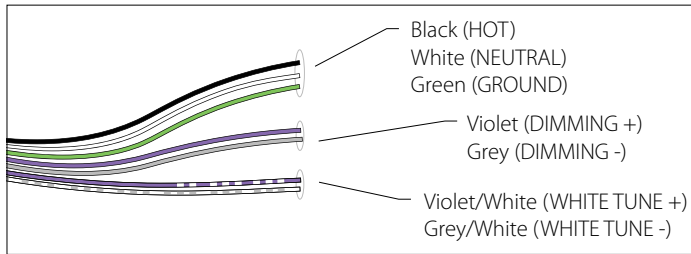

SpectraSync Tunable White luminaires are provided with two 0–10V circuits. The violet and grey circuit is for wiring to any qualified 0–10V controller for dimming. The violet/white and grey/white circuit is for wiring to any qualified 0–10V controller for Tunable White CCT control.

Controller Manufacturer Data

SpectraSync Tunable White was designed to be used with sinking style dimmers (provided by others) and is compatible with:

- Hubbell Control Solutions (HCS): NX Distributed Intelligence™ Room Controllers (NXRC) and In-fixture Controllers (NXFM)
- Lutron: DDTV, DVSTV, and NFTV dimmers
- Wattstopper: ADF120277 and CD4BL (Titan) dimmers

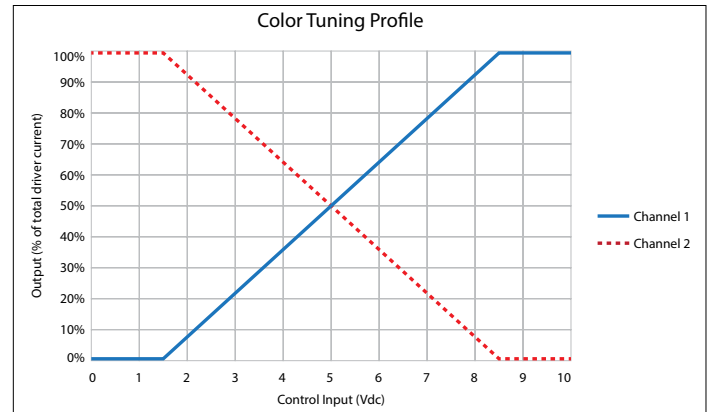

To enable scheduling and for use with NX wall control preset stations please refer to Hubbell Control Solutions NX SpectraSync technical sheet.

LTR-4RW-RFH Open SpectraSync

LITEISTRY 4" ROUND OPEN WALL WASH (WW/DWW) WITH COLOR TUNING

DIMENSIONS

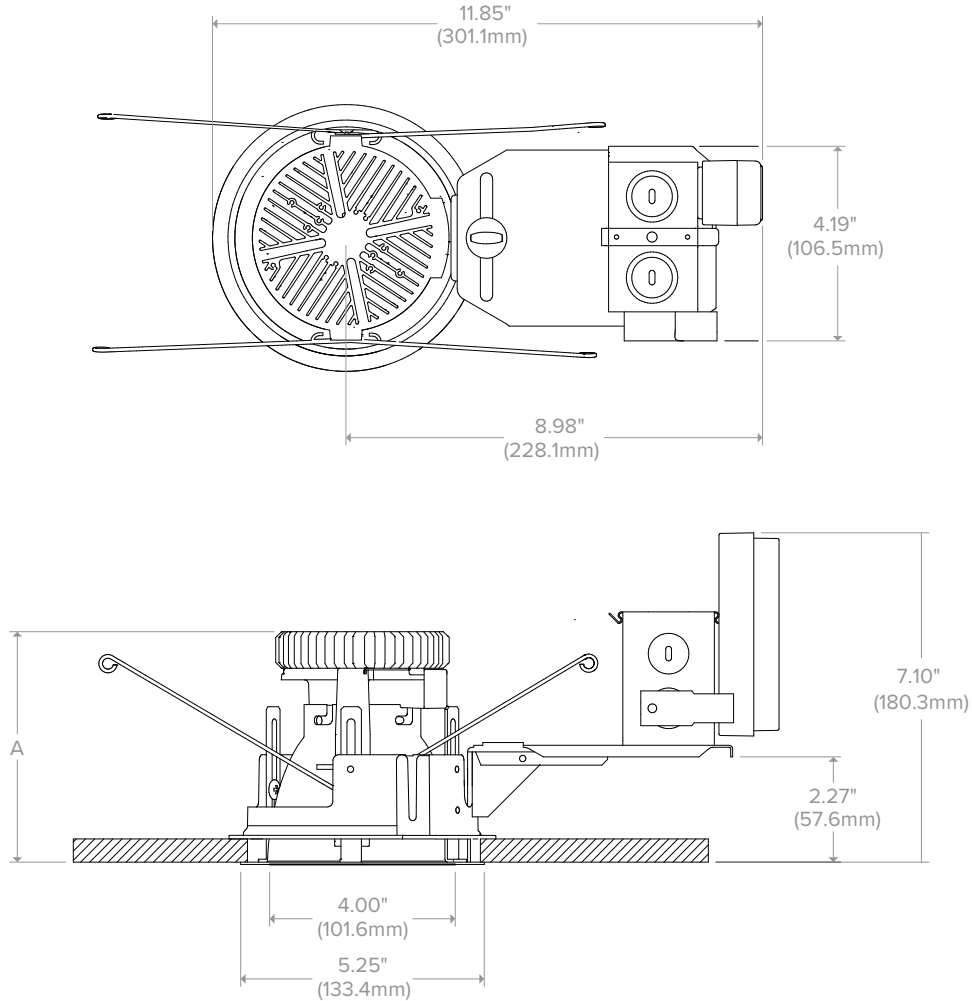

Housing Compatibility Guide			
Existing Frame Opening**		Use Housing	Use Flange Option
MIN	MAX		
4.75" (120.7mm)	5.00" (127.0mm)	-RFH	(Standard)
5.00" (127.0mm)	5.50" (139.7mm)	-RFHW	WF

Dimensional Data		
Aperture		4.00" (101.6mm)
Flange:	Standard	5.25" (133.4mm)
	Wide (WF)	5.75" (146.1mm)
Ceiling Cutout:	Standard	5.00" (127.0mm)
Ceiling Thickness:		0.50" to 2.00" (12.7mm to 50.8mm)

Lumen Package	"A"
06L-10L	4.97" (126.2mm)
15L	7.33" (186.2mm)

LTR-4RW-RFH

LTR-4RW-RFH Open SpectraSync

LITEISTRY 4" ROUND OPEN WALL WASH (WW/DWW) WITH COLOR TUNING

PHOTOMETRY

LTR-4RD-H-ML15L-DMT / LTR-4RW-T-ML2765T9WWS

LUMINAIRE DATA

Test No.	R19.00750-16
Description	Single Wall Wash, 1500 lm, 3000K, 90 CRI
Delivered Lumens	1279
Watts	23.0W
Efficacy	56.0
Mounting	Recessed

ZONAL LUMEN SUMMARY

Zone	Lumens	% Luminaire
0-40	1142	89.3
0-60	1260	98.5
0-90	1279	100.0
0-180	1279	100.0

POLAR GRAPH

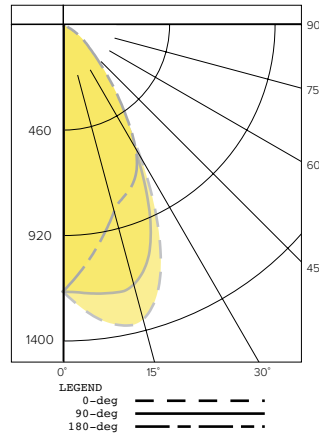

CANDELA DISTRIBUTION

Degree	Candela
0	1222
5	1112
15	894
25	778
35	503
45	314
55	111
65	44
75	8
85	1
90	0

LUMINANCE DATA*

Vertical Angle	Average
45°	37935
55°	22474
65°	12165
75°	3742
85°	1710

*Candela/Square Meter

LTR-4RW-RFH Open SpectraSync

LITEISTRY 4" ROUND OPEN WALL WASH (WW/DWW) WITH COLOR TUNING

TM-30 DATA

SPECTRASYNCTM TUNABLE WHITE (2765T)

COLOR VECTOR GRAPHIC
2700K, 90+ CRI

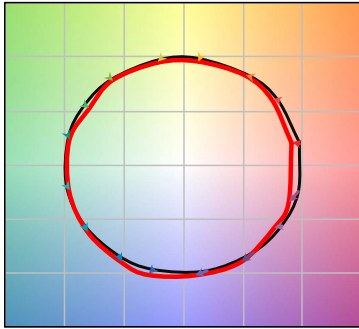

— Reference Illuminant — Test Source

COLOR DISTORTION GRAPHIC
2700K, 90+ CRI



COLOR VECTOR GRAPHIC
4600K, 90+ CRI

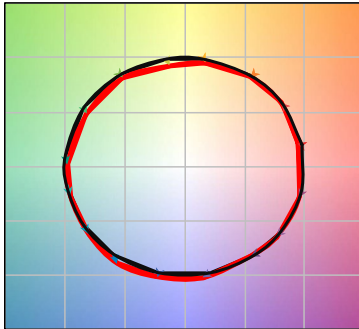

— Reference Illuminant — Test Source

COLOR DISTORTION GRAPHIC
4600K, 90+ CRI



COLOR VECTOR GRAPHIC
6500K, 90+ CRI

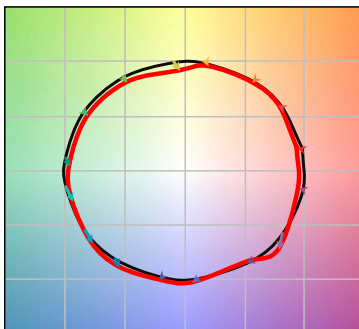

— Reference Illuminant — Test Source

COLOR DISTORTION GRAPHIC
6500K, 90+ CRI



TEST RESULTS - TUNABLE WHITE @ 1500 LUMENS (NOMINAL)			
Value	2700K	4600K	6500K
Luminous Flux (lm)	1407	1604	1660
Wattage (W)	23.9	24.3	24.6
Efficacy (lm/W)	59	66	68
R _f	90	89	87
R _g	97	98	96
CCT (K)	2817	4588	6518
D _{UV}	-0.0013	-0.0040	0.0018
x	0.4482	0.3565	0.3131
y	0.4047	0.3531	0.3273
CIE R _a	91	95	94
CIE R _g	47	81	76

LTR-4RW-RFH Open SpectraSync

LITEISTRY 4" ROUND OPEN WALL WASH (WW/DWW) WITH COLOR TUNING

TM-30 DATA CONTINUED

SPECTRASYNCTM DIM TO WARM (2230TD)

COLOR VECTOR GRAPHIC
3000K, 90+ CRI @ 100%

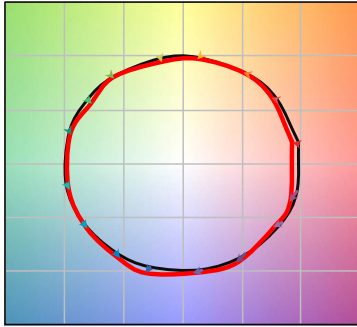

— Reference Illuminant — Test Source

COLOR DISTORTION GRAPHIC
3000K, 90+ CRI @ 100%



COLOR VECTOR GRAPHIC
2600K, 90 CRI @ 50% DIM

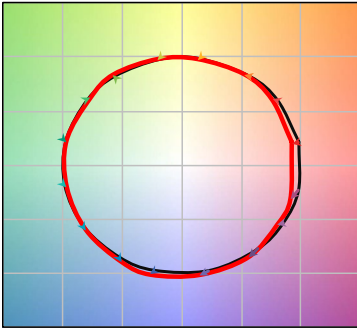

— Reference Illuminant — Test Source

COLOR DISTORTION GRAPHIC
2600K, 90 CRI @ 50% DIM

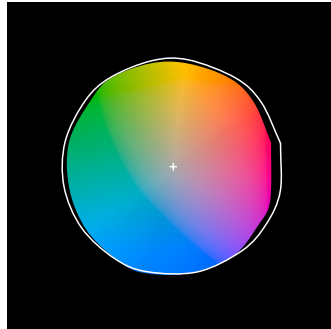

COLOR VECTOR GRAPHIC
2200K, 90 CRI @ 5% DIM

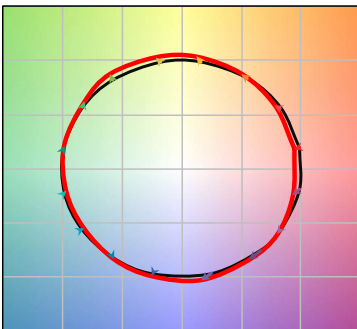

— Reference Illuminant — Test Source

COLOR DISTORTION GRAPHIC
2200K, 90 CRI @ 5% DIM

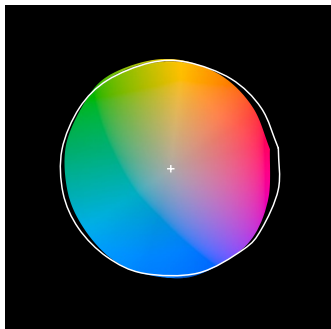

TEST RESULTS - DIM TO WARM @ 3 DIMMING LEVELS			
Value	100%	50% Dim	5% Dim
Luminous Flux (lm)	1501	772	53
Wattage (W)	24.3	14	3.4
Efficacy (lm/W)	62	55	16
R _f	90	92	91
R _g	97	99	102
CCT (K)	3123	2590	2282
D _{uv}	-0.0017	-0.0015	-0.0029
x	0.4261	0.4662	0.4907
y	0.3965	0.4082	0.4068
CIE R _a	92	93	93
CIE R _g	53	60	64

LTR-4RW-RFH Open SpectraSync

LITEISTRY 4" ROUND OPEN WALL WASH (WW/DWW) WITH COLOR TUNING

ELECTRICAL DATA

DRIVER DATA	
Input Voltage	120-277 V
Input Frequency	50/60 Hz
Power Factor	≥0.90
THD	<20%
EMI Filtering (FCC 47 CFR Part 15)	Class A

WATTAGE DATA		
Lumen Output	Nominal Lumens	Wattage
06L	600	10
10L	1000	18
15L	1500	25

* Wattage may vary based on configuration and options selected

ADDITIONAL INFORMATION

Central Inverters

For full fixture output in back-up mode, we recommend you visit www.dual-lite.com for your Central Lighting Inverter options. Please contact your local Hubbell representative for any assistance with proper sizing and loading of your inverter selection. Central lighting inverters must be ordered separately.

LiteGear: www.dual-lite.com/products/litegear_lg_series

LPS Series: www.dual-lite.com/products/lps