

LTR-6RD-RFH SpectraSync

LITEISTRY 6" ROUND DOWNLIGHT WITH COLOR TUNING

LITEISTRY™

FEATURES

- 6" architectural LED downlight delivering 600 – 2500 lm
- Four beam distributions from 0.3 to 1.1 Spacing Criteria
- Quiet reflector appearance with superior 50° optical cutoff
- SpectraSync™ Color Tuning technology allows the flexibility to tailor CCT to aesthetic preferences
- Available in Dim to Warm (2200K-3000K) or Tunable White (2700K-5000K or 2700K-6500K), 90+ CRI
- Available for Retrofit (non-IC) applications
- Standard with 0-10V dimming to 5%



RELATED PRODUCTS

Ø 3" LITEISTRY Family

Ø 4" LITEISTRY Family

Ø 6" LITEISTRY Family

CONTROL TECHNOLOGY



SPECIFICATIONS

CONSTRUCTION

- Die cast aluminum mounting ring with 5 axis adjustable junction box
- Retrofit housing allows below ceiling installation without removing the existing fixture
- Pre-wired junction box with snap-on covers for easy access
- Snap-in connection from driver compartment allows easy installation
- Light Engine connections use plenum rated (CMP) cable

OPTICS

- Visually pleasing 50° cutoff to source and source image
- The light distribution is free of distracting bright spots or pixelation and the perimeter has a smooth transition
- Optical grade silicone lens integral to light engine
- High purity spun aluminum reflector, self-flanged
- Large selection of anodized finishes and colors
- Painted cones and flange options available

ELECTRICAL

- LED array with 3 SDCM color consistency
- Dim to Warm (2200K-3000K) or Tunable White (2700K-5000K or 2700K-6500K) options available
- 90+ CRI standard
- Long LED life: L70 at >60,000 hours (TM-21)
- Universal voltage 120V–277V driver,
- UL Class 2, inherent short circuit and overload protection, RoHS compliant
- Flicker free 0–10V dimming to 5%
- Refer to additional spec sheets for information on [standard LITEISTRY](#) or [PowerHUBB™ PoE enabled](#) solutions

INSTALLATION

- Accommodates ceiling thickness up to 2"
- Light Engine and driver serviceable from above or below ceiling.

CERTIFICATIONS

- cCSAus certified to UL 1598
- Suitable for wet locations, covered ceiling
- Approved for 8 (4 in/4 out) No. 12AWG conductors rated for 90°C through wiring
- This product qualifies as a “designated country construction material” per FAR 52.225-11 Buy American-Construction. Materials under Trade Agreements effective 6/6/2020. See [Buy American Solutions](#).

WARRANTY

- 5 year warranty
- See [HLI Standard Warranty](#) for additional information

KEY DATA	
Lumen Range	600-2500
Wattage Range	10-38
Efficacy Range (LPW)	55-61*
Reported Life (Hours)	L70 / >60,000
Input Current (mA)	83-317 (120V)

*Based on Specular, 30K, 90 CRI



LTR-6RD-RFH SpectraSync

LITEISTRY 6" ROUND DOWNLIGHT WITH COLOR TUNING

DATE: _____ LOCATION: _____

TYPE: _____ PROJECT: _____

CATALOG #: _____

ORDERING GUIDE

Example: LTR-6RD-RFH-SL10L-DMTW-LTR-6RD-T-SL2230TD9MD-S

CATALOG #

HOUSING

LTR-6RD-RFH		Lumen Package		Lumen Output		Driver Options		Voltage		Housing Options	
Aperture/Shape/Function											
LTR-6RD-RFH	6" Round Downlight Retrofit Housing ⁵	SL	Standard Lumen	06L	600	DMTW	SpectraSync™ Dim to Warm, 0-10V Dimming to 5% ¹	Standard	120-277V	F	Fuse
				10L	1000						
		ML	Medium Lumen	15L	1500						
LTR-6RD-RFHW	6" Round Downlight Retrofit Housing (for Wide Diameter) ⁵	HL	High Lumen	20L	2000	DMT	SpectraSync™ Tunable White, 0-10V Dimming to 5% ²				
				25L	2500						

TRIM

LTR-6RD-T		Lumen Package		CCT		CRI		Distribution	
Aperture/Shape/Function									
LTR-6RD-T	6" Round Downlight Light Engine/Trim Assembly	SL	Standard Lumen	2230TD	2200K-3000K SpectraSync™ Dim to Warm	9	90+CRI	NR	Narrow (0.3 SC/18°)
		ML	Medium Lumen	2750T	2700K-5000K SpectraSync™ Tunable White			MD	Medium (0.6 SC/37°)
		HL	High Lumen	2765T	2700K-6500K SpectraSync™ Tunable White			WD	Wide (0.9 SC/59°)
								XW	Extra Wide (1.1 SC/76°)

TRIM CONTINUED

Reflector Finish		Reflector Color		Flange Color Options		Lower Trim Options		Reflector Options	
<i>Finish not applicable with painted reflectors (WC or BC)</i>		Standard Clear		Standard matches reflector color		WF Wide Flange		AM Antimicrobial Coating ⁴	
S	Specular	CG	Champagne Gold	WT	White Flange ³				
SS	Semi-Specular	BL	Black	BT	Black Flange ³				
MFC	American Matte™	LW	Light Wheat						
VS	Softglow®	PW	Pewter						
VSS	SoftSheen™	WC	Painted White Cone and Flange						
		BC	Painted Black Cone and Flange						

Accessories

- LiteGear** LiteGear® Inverter, 125VA-250VA
- LPS Series** LightPower Micro-Inverter, 20VA-55VA
- MOR6-R-WH** Metal Oversized Ring, 6" Round, White (10" outside diameter)
- MOR6-R-BL** Metal Oversized Ring, 6" Round, Black (10" outside diameter)

Notes:

- 1 Must select 2230TD with DMTW driver.
- 2 Must select either 2750T or 2765T with DMT driver.
- 3 WT not needed for WC, BT not needed for BC.
- 4 AM available with WC or Specular Clear (S or SWT). Consult factory for other colors.
- 5 See line art for compatibility with existing aperture diameters.

LTR-6RD-RFH SpectraSync

LITEISTRY 6" ROUND DOWNLIGHT WITH COLOR TUNING

CONTROLS

SpectraSync™ Color Tuning Technology:

Control your space based on the needs of the application, specific activities throughout the day and preferences of the occupants with distinct SpectraSync™ Color Tuning Technologies.



SPECTRASYNCH COLOR TUNING TECHNOLOGY		
Mode	Kelvin Range	Description
Dim to Warm	2200K-3000K	Mimics the familiar warming effect that occurs with traditional incandescent sources as they are dimmed
Tunable White	2700K-5000K 2700K-6500K	Offers users the ability to tailor CCT to their personal preference, enhancing task visibility, material and colors or the aesthetics of the space
Scheduled White	2700K-5000K 2700K-6500K	Mimics the rhythm of natural light or follows an alternative user-defined schedule throughout the day, enhancing an occupant's mood and well-being

SpectraSync Tunable White

Available in two options: 2750T (2700K–5000K) or 2765T (2700K–6500K). Requires two 0–10V controllers, one for intensity and one for CCT. Minimum 5% dimming.

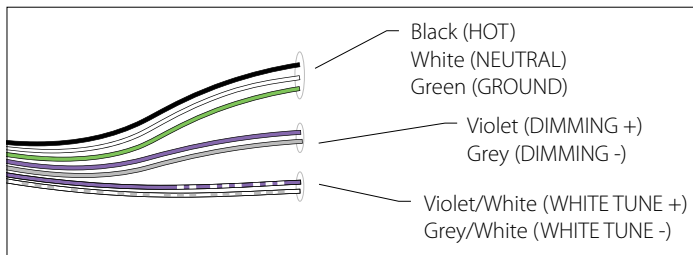

SpectraSync Tunable White luminaires are provided with two 0–10V circuits. The violet and grey circuit is for wiring to any qualified 0–10V controller for dimming. The violet/white and grey/white circuit is for wiring to any qualified 0–10V controller for Tunable White CCT control.

Controller Manufacturer Data

SpectraSync Tunable White was designed to be used with sinking style dimmers (provided by others) and is compatible with:

- Hubbell Control Solutions (HCS): NX Distributed Intelligence™ Room Controllers (NXRC) and In-fixture Controllers (NXFM)
- Lutron: DDTV, DVSTV, and NDTV dimmers
- Wattstopper: ADF120277 and CD4BL (Titan) dimmers

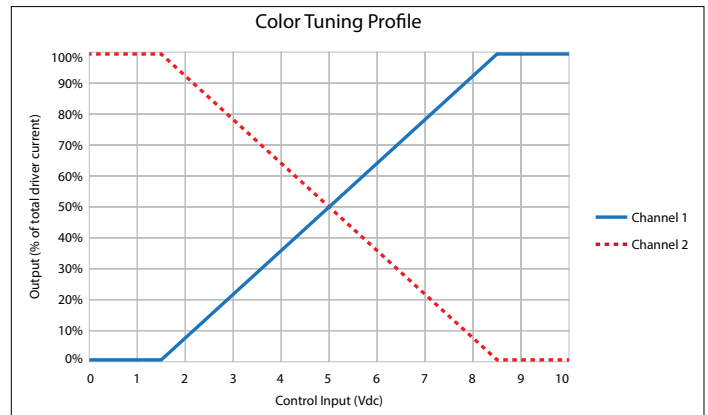

To enable scheduling and for use with NX wall control preset stations please refer to Hubbell Control Solutions NX SpectraSync technical sheet.

LTR-6RD-RFH SpectraSync

LITEISTRY 6" ROUND DOWNLIGHT WITH COLOR TUNING

DIMENSIONS

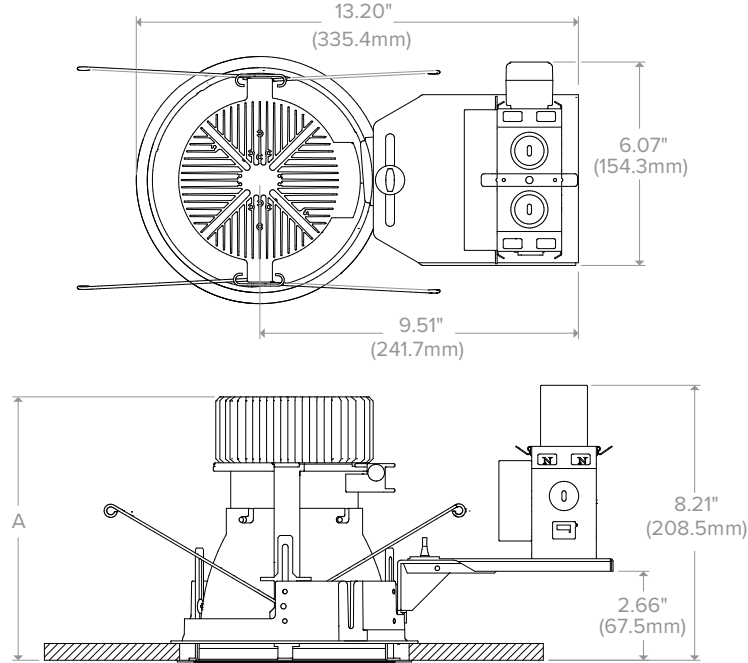

Housing Compatibility Guide			
Existing Frame Opening**		Use Housing	Use Flange Option
MIN	MAX		
6.25" (156.3mm)	6.50" (165.1mm)	-RFH	(Standard)
6.63" (168.4mm)	6.88" (172.0mm)	-RFHW	WF

Dimensional Data	
Aperture	5.75" (146.1mm)
Flange:	Standard
	Wide (WF)
Ceiling Cutout:	Standard
Ceiling Thickness:	0.50" to 2.00" (12.7mm to 50.8mm)

Lumen Package	"A"
06L-10L	5.90" (149.9mm)
15L-20L	7.86" (199.6mm)
25L	9.04" (229.6mm)

LTR-6RD-RFH/-RFHW

LTR-6RD-RFH SpectraSync

LITEISTRY 6" ROUND DOWNLIGHT WITH COLOR TUNING

PHOTOMETRY

LTR-6RD-RFH-ML20L-DMT / LTR-6RD-T-ML2765T9NRS

LUMINAIRE DATA

Test No.	R19.02201-C02
Description	2000 lm, Narrow, 3000K, 90 CRI
Delivered Lumens	2146
Watts	35.2W
Efficacy	61.0
Mounting	Recessed
Spacing Criterion	0.4
Beam Angle (FWHM)	18

POLAR GRAPH

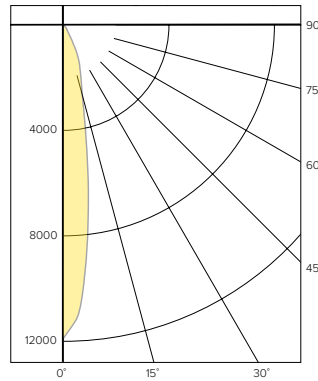

CANDELA DISTRIBUTION

Degree	Candela
0	7976
5	6898
15	2784
25	1179
35	263
45	72
55	0
65	0
75	0
85	0
90	0

LUMINANCE DATA*

Vertical Angle	Average
45°	6072
55°	0
65°	0
75°	0
85°	0

*Candela/Square Meter

ZONAL LUMEN SUMMARY

Zone	Lumens	% Luminaire
0-40	2083	97.1
0-60	2146	100.0
0-90	2146	100.0
0-180	2146	100.0

LTR-6RD-RFH-ML20L-DMT / LTR-6RD-T-ML2765T9MDS

LUMINAIRE DATA

Test No.	R19.02200-C02
Description	2000 lm, Medium, 3000K, 90 CRI
Delivered Lumens	2077
Watts	35.4W
Efficacy	59.0
Mounting	Recessed
Spacing Criterion	0.6
Beam Angle (FWHM)	37

POLAR GRAPH

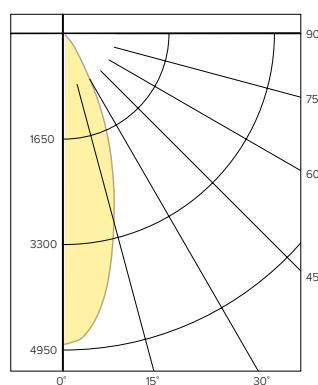

CANDELA DISTRIBUTION

Degree	Candela
0	4221
5	4036
15	2741
25	1362
35	369
45	91
55	6
65	2
75	1
85	0
90	0

LUMINANCE DATA*

Vertical Angle	Average
45°	7675
55°	624
65°	282
75°	230
85°	0

*Candela/Square Meter

ZONAL LUMEN SUMMARY

Zone	Lumens	% Luminaire
0-40	1992	95.9
0-60	2074	99.9
0-90	2077	100.0
0-180	2077	100.0

LTR-6RD-RFH-ML20L-DMT / LTR-6RD-T-ML2765T9WDS

LUMINAIRE DATA

Test No.	R19.02199-C02
Description	2000 lm, Wide, 3000K, 90 CRI
Delivered Lumens	1989
Watts	35.3W
Efficacy	56.0
Mounting	Recessed
Spacing Criterion	0.9
Beam Angle (FWHM)	59

POLAR GRAPH

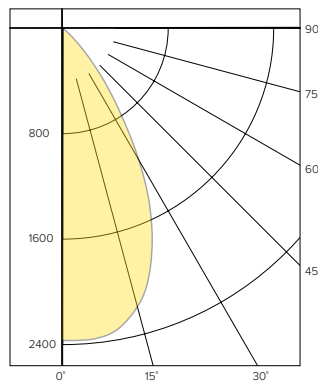

CANDELA DISTRIBUTION

Degree	Candela
0	2069
5	2080
15	1973
25	1454
35	677
45	168
55	10
65	3
75	1
85	0
90	0

LUMINANCE DATA*

Vertical Angle	Average
45°	14168
55°	1040
65°	423
75°	230
85°	0

*Candela/Square Meter

ZONAL LUMEN SUMMARY

Zone	Lumens	% Luminaire
0-40	1833	92.1
0-60	1985	99.8
0-90	1989	100.0
0-180	1989	100.0

LTR-6RD-RFH SpectraSync

LITEISTRY 6" ROUND DOWNLIGHT WITH COLOR TUNING

PHOTOMETRY CONTINUED

LTR-6RD-RFH-ML20L-DMT / LTR-6RD-T-ML2765T9XWS

LUMINAIRE DATA

Test No.	R19.00586-C02
Description	2000 lm, Extra Wide, 3000K, 90 CRI
Delivered Lumens	1951
Watts	35.3W
Efficacy	55.0
Mounting	Recessed
Spacing Criterion	1.1
Beam Angle (FWHM)	76

ZONAL LUMEN SUMMARY

Zone	Lumens	% Luminaire
0-40	1711	87.7
0-60	1946	99.8
0-90	1951	100.0
0-180	1951	100.0

POLAR GRAPH

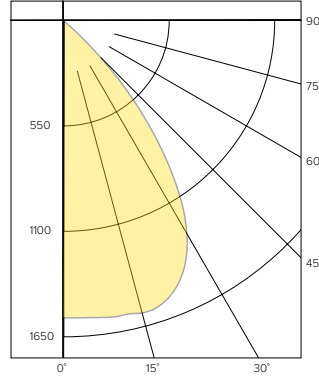

CANDELA DISTRIBUTION

Degree	Candela
0	1411
5	1416
15	1437
25	1333
35	919
45	275
55	8
65	3
75	1
85	0
90	0

LUMINANCE DATA*

Vertical Angle	Average
45°	23154
55°	853
65°	386
75°	210
85°	0

*Candela/Square Meter

LTR-6RD-RFH SpectraSync

LITEISTRY 6" ROUND DOWNLIGHT WITH COLOR TUNING

TM-30 DATA

SPECTRASYNCTM TUNABLE WHITE (2765T)

COLOR VECTOR GRAPHIC
2700K, 90+ CRI

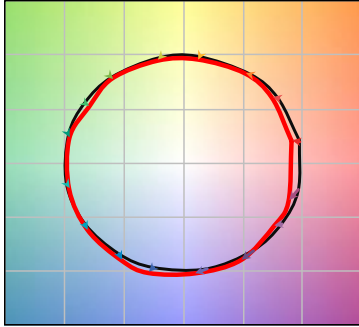

— Reference Illuminant — Test Source

COLOR DISTORTION GRAPHIC
2700K, 90+ CRI



COLOR VECTOR GRAPHIC
4600K, 90+ CRI

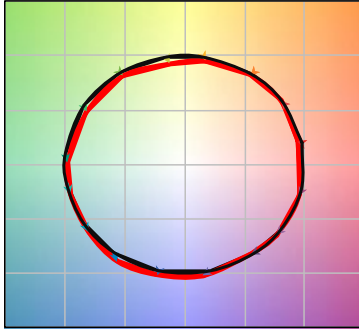

— Reference Illuminant — Test Source

COLOR DISTORTION GRAPHIC
4600K, 90+ CRI



COLOR VECTOR GRAPHIC
6500K, 90+ CRI

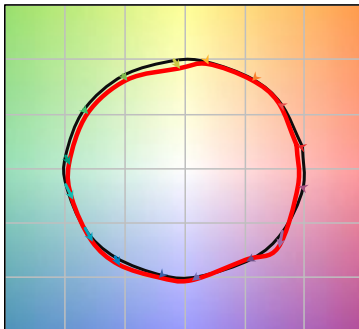

— Reference Illuminant — Test Source

COLOR DISTORTION GRAPHIC
6500K, 90+ CRI



TEST RESULTS - TUNABLE WHITE @ 1500 LUMENS (NOMINAL)			
Value	2700K	4600K	6500K
Luminous Flux (lm)	1407	1604	1660
Wattage (W)	23.9	24.3	24.6
Efficacy (lm/W)	59	66	68
R _f	90	89	87
R _g	97	98	96
CCT (K)	2817	4588	6518
D _{UV}	-0.0013	-0.0040	0.0018
x	0.4482	0.3565	0.3131
y	0.4047	0.3531	0.3273
CIE R _a	91	95	94
CIE R _g	47	81	76

LTR-6RD-RFH SpectraSync

LITEISTRY 6" ROUND DOWNLIGHT WITH COLOR TUNING

TM-30 DATA CONTINUED

SPECTRASYNCTM DIM TO WARM (2230TD)

COLOR VECTOR GRAPHIC
3000K, 90+ CRI @ 100%

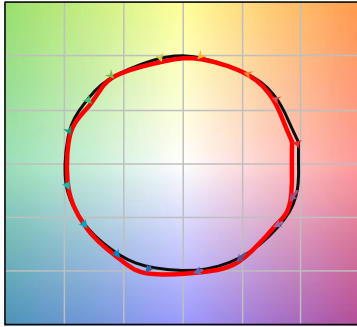

— Reference Illuminant — Test Source

COLOR DISTORTION GRAPHIC
3000K, 90+ CRI @ 100%



COLOR VECTOR GRAPHIC
2600K, 90 CRI @ 50% DIM

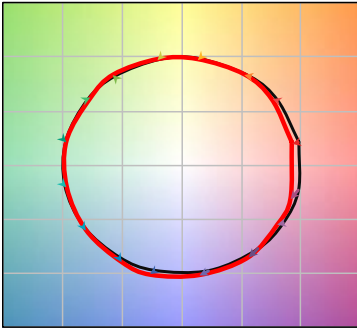

— Reference Illuminant — Test Source

COLOR DISTORTION GRAPHIC
2600K, 90 CRI @ 50% DIM



COLOR VECTOR GRAPHIC
2200K, 90 CRI @ 5% DIM

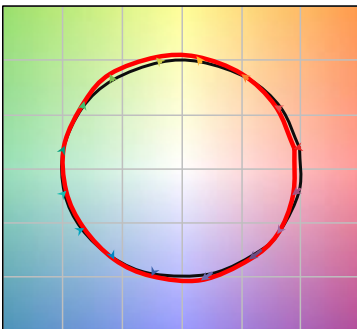

— Reference Illuminant — Test Source

COLOR DISTORTION GRAPHIC
2200K, 90 CRI @ 5% DIM

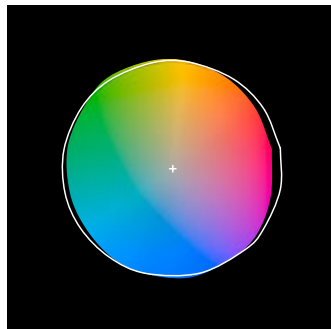

TEST RESULTS - DIM TO WARM @ 3 DIMMING LEVELS			
Value	100%	50% Dim	5% Dim
Luminous Flux (lm)	1501	772	53
Wattage (W)	24.3	14	3.4
Efficacy (lm/W)	62	55	16
R _f	90	92	91
R _g	97	99	102
CCT (K)	3123	2590	2282
D _{uv}	-0.0017	-0.0015	-0.0029
x	0.4261	0.4662	0.4907
y	0.3965	0.4082	0.4068
CIE R _a	92	93	93
CIE R _g	53	60	64



LTR-6RD-RFH SpectraSync

LITEISTRY 6" ROUND DOWNLIGHT WITH COLOR TUNING

DATE: _____ LOCATION: _____

TYPE: _____ PROJECT: _____

CATALOG #: _____

ELECTRICAL DATA

DRIVER DATA	
Input Voltage	120-277 V
Input Frequency	50/60 Hz
Power Factor	≥0.90
THD	<20%
EMI Filtering (FCC 47 CFR Part 15)	Class A

WATTAGE DATA		
Lumen Output	Nominal Lumens	WATTAGE
06L	600	10
10L	1000	18
15L	1500	25
20L	2000	36
25L	2500	38

* Wattage may vary based on configuration and options selected

ADDITIONAL INFORMATION

Central Inverters

For full fixture output in back-up mode, we recommend you visit www.dual-lite.com for your Central Lighting Inverter options. Please contact your local Hubbell representative for any assistance with proper sizing and loading of your inverter selection. Central lighting inverters must be ordered separately.

LiteGear: www.dual-lite.com/products/litegear_lg_series

LPS Series: www.dual-lite.com/products/lps

All product and company names, logos and product identifiers are trademarks ™ or registered trademarks ® of Hubbell Lighting, Inc. or their respective owners. Use of them does not necessarily imply any affiliation with or endorsement by such respective owners.