



P30SK

18.5W PAR30 LED



5 Holt Drive,
Stony Point, NY 10980
845-947-3034
info@tslight.com

The P30SK's size makes this unit ideal for short throw lighting in galleries, museums, retail and residential applications. Equipped with a self-locking yoke and accessory-retaining clips that accepts louvers, barndoors, hoods and filters. Comes in standard black, white and silver finishes. Custom colors are available by request and at an additional charge.

By utilizing Sora's Snap System, there are unlimited possibilities for customizing this fixture. Options include the ability to field change the beam angle (Beam Spreader Snap), alter color temperature (CTO Snap), or to add a louver. Color Snaps can be used to produce brilliant hues of any color that Rosco or Lee offer.

Manufactured in the USA - IBEW



LED

- 9° SORAA lamp included - use snaps to change the beam angle.
- Color temp options: 2700K, 3000K, 4000K
- CRI: 85 or 95
- No UV or IR

Dimming*

- Trailing edge (ELV)
- Leading edge (Triac)

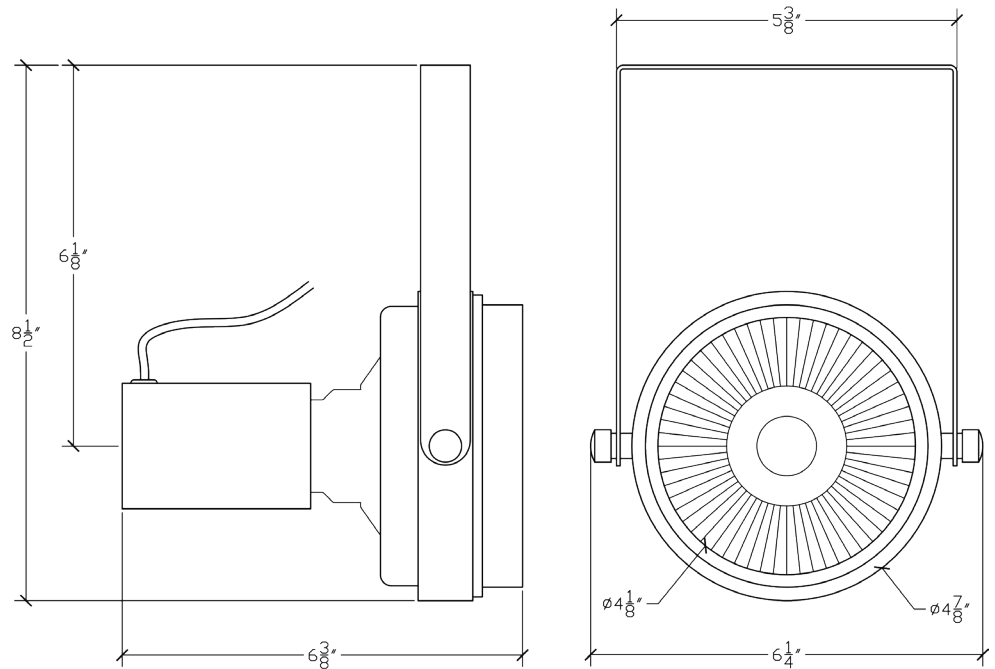

Features

- Numerous mounting options and accessories
- Weight: 1.7 lbs

Lamp Type	Watts	CRI	Lumens*
Brilliant	18.5	90 (R9=0)	1280
Vivid	18.5	95 (R9=95)	1000

* Lumens vary depending on color temperature – results for 3000K lamp used above

Ordering Matrix

Model	CRI	Color Temperature	Color	Mounting Options	Accessories
P30SK	95 90	27 = 2700K 30 = 3000K	B = Black W = White S = Silver CC = Custom Color	See Mounting Options	See Accessory Options

* All fixtures sold with 9° beam angle lamps - use Beam Spreaders to achieve desired angle.

Example: P30SK-95-27-B-AD1-01145

P30SK - _____ - _____ - _____ - _____ - _____

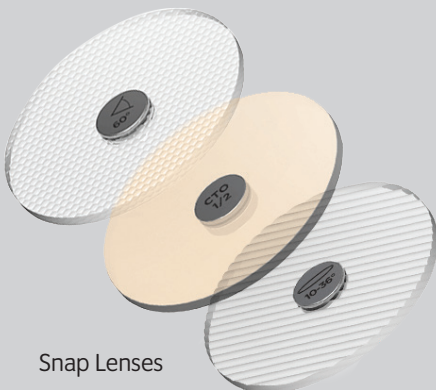

Snap Lenses

* Specification sheets are subject to change without notice.

Photometrics

9° Degree Beam

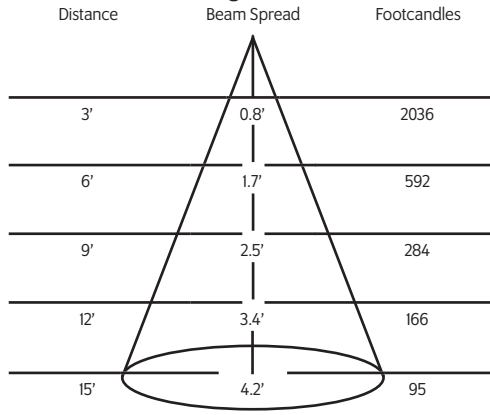

25° Degree Beam

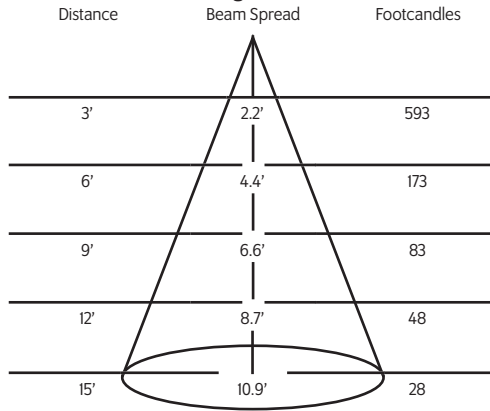

36° Degree Beam

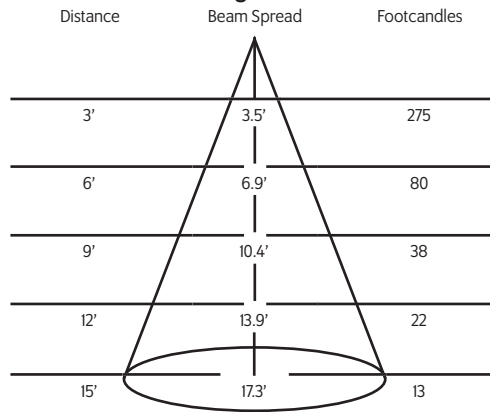

60° Degree Beam

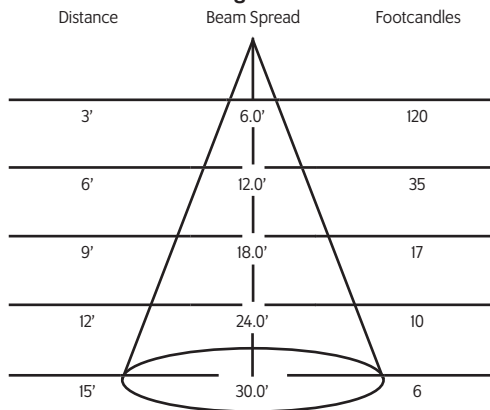

* Testing done on 3000K unit: Lumen output changes based on color temperature.

Mounting Options

AD1 Track Adapter for commercial grade 1 & 2 circuit track. 120V. For use with lightweight fixtures.

DT2 2-circuit track adapter for SpecTrack databus. 120V.

TA2 Track adapter for G-Series specification grade 2-circuit track. 120V.

TA3 Track adapter for G-Series specification grade 3-circuit track. 120V.

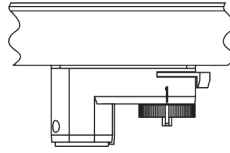

CM4 Canopy Mount

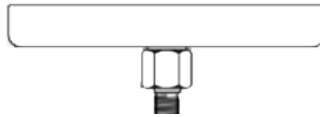

US1 6⁵/₁₆" x 1¹/₂" Unistrut Adapter



TB4 6¹/₄" Portable wall mount/table base floor, wall or table use.



MC Light duty pipe clamp for small fixtures. For pipes up to 1⁵/₁₆" O.D.

MN Medium duty pipe clamp for small to large fixtures. For pipes up to 2" O.D.

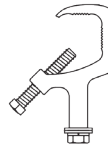

Accessories

LV6	Louver
XL6	Cross Baffle Louver
HD6	Hood
XH6	Cross Baffle Hood
CC18	Coiled Cord

Snap Accessories

01145	25° Beam Spreader Snap
01147	36° Beam Spreader Snap
01149	60° Beam Spreader Snap
01595	10°-36° Linear Snap
03261	10°-60° Linear Snap
01597	36°X36° Flat Top Snap
01151	40° Cutoff Louver
03257	20° Maximum Deflection Snap
01153	¼ Color Temperature Shift Snap
01155	½ Color Temperature Shift Snap
01157	¾ Color Temperature Shift Snap
03283	Enhance Snap
02185-C	Color Snap (Specify Color)
CC18	Coil Cord

Extension Wands

SP 12	12" Stem
SP 18	18" Stem
SP 24	24" Stem
SP X	Custom Length

Finish

B	Black
W	White
S	Silver
CC	Custom Color