



a brand of TARGETTI

DURATAPE™ RGBW IP20 INDOOR

KEY FEATURES

- High output RGB colors along side warm white. Introducing a white spectrum with saturated sharp RGB tones working together to create soft pastel tones or different tones of white enriched with RGB colors.
- Ideal for IP20 interior applications such as cove, niche, architectural decorative application, lighting accents, custom and OEM product designs/chandeliers.
- Sold per foot and manufactured to specified lengths with factory attached end preps.
- Features 2-circuit substrate for optimum heat dissipation, minimizing voltage drop while increasing run lengths per power feed, standardizing electrical flow over entire length of the strip for maximum product reliability.
- Features double sided solder points for maximum conductivity and durability.
- Pre-assembled to specific lengths with various connector options for project requirements and efficient power configuration.
- Max continuous length: up to 16' per run
- Multiple DMX512 driver options available.



DETAILS

Spacing	0.47" OC LED Spacing
LEDs	25 LEDs per foot
Wattage	4.4W/ft
Color Temp	Quad Chip: Red 625nm / Green 520nm / Blue 450nm / 2700°K White
Color Consistency	Bin centered on the Planck curve with a 2 step MacAdam tolerance.
End Preps	Factory preped end preps available (See Page 2)
Mounting	Includes installation-ready 3M tape adhesive for simplified installation directly to mounting channel or application surface.
Installation	Optional aluminum channels with base and cover can be used to install decorative, protective covers.
Power Supply	Listed Class 2 output, 24V DC power supply required
Listing	cULus Class 2 Listed E471161 Tested in accordance with LM-79-08 Energy efficient for California installations.
Compliance	ROHS compliant
Warranty	5 year warranty

DIMENSIONAL DRAWINGS

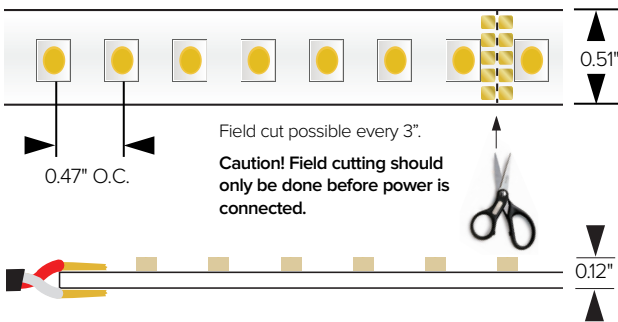

Duratape features double-sided solder points for maximum continuity for long lifespan.

FIXTURE DATA

Model	Efficacy Lm/Wt	Lm/Ft	Wt/Ft
RGBW*	36	158.5	4.4

* Meets Title 24 High efficacy rating.

LED DATA

Model	Wt/LED	Viewing Angle	Lifespan at 90% drive
RGBW	0.18	120°	40,000hrs

* LEDs operating at 90% of LED manufacturers maximum current rating.

DESIGN INSTALLATION EXAMPLES



PRODUCT CODE	INTENSITY	WATTAGE	IP RATING	LED COLOR	VOLTAGE	+	END PREP	+	MOUNTING	+	POWER SUPPLY
--------------	-----------	---------	-----------	-----------	---------	---	----------	---	----------	---	--------------

DL — Duratape™ HO — High Output 44 — 4.4 W/ft I — Indoor IP20 RGBW — Red 625nm / Green 520nm / Blue 450nm / 2700°K 24 — 24 VDC

END PREPS AND CONNECTORS (REQUIRED) - Choose 1

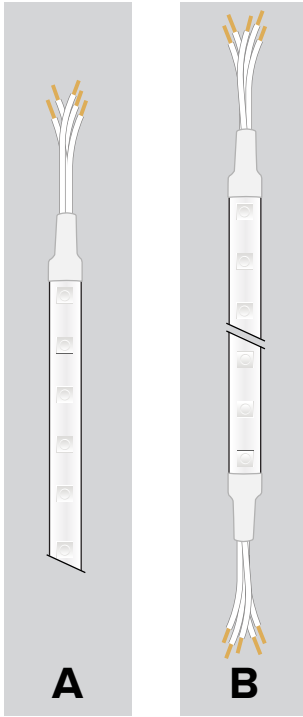

REQUIRED END PREPS:

(One required for each run of tape)

A

07UI4CBL1 (4-circuit RGBW or RGB+W)
Factory attached single 4 circuit lead wire prep. 24" five conductor Lead wire/dead end allows for connection to power at lead end and field trim of Duratape product at the other end.

07UI4ADDCBL: ADDITIONAL LEAD WIRE
(4-circuit RGBW or RGB+W)

Additional lead wire purchased per foot and factory attached to specified run leads. Lead wire can be field cut to desired length.

B

07UI4CBL2 (4-circuit RGBW or RGB+W)
Factory attached double ended 4 circuit lead wire prep. 24" five conductor lead wire at both ends. One end can be used for power connectivity while the other end can be used for interconnection to run to an additional length of Duratape.

07UI4ADDCBL: ADDITIONAL LEAD WIRE
(4-circuit RGBW or RGB+W)

Factory attached single 4 circuit lead wire prep. 24" four conductor Lead wire/dead end allows for connection to power at lead end and field trim of Duratape product at the other end.

PROFILE OPACITY LEVEL KEY:



Uniform
Direct View



Blended
Direct / Indirect View



Pixelated
Indirect View

SURFACE PROFILES

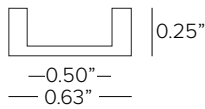
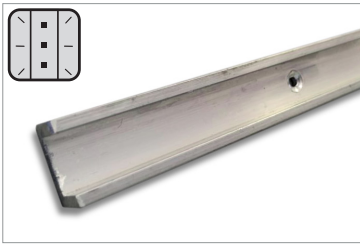

DL-ALUM-U-8

Low profile aluminum U-Profile for linear run lengths. Available in 8ft lengths.

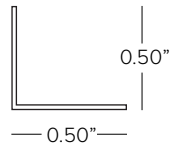
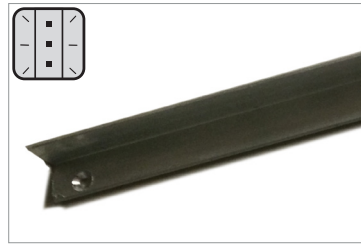

DL-ALUM-L-8

Aluminum L-Profile 1/2" x 1/2" for linear run lengths. Duratape can be mounted at either 0° or 90° mounting positions. Available in 8ft lengths.

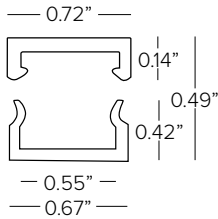

DL-W-2PC-C (Clear)

DL-W-2PC-F10/F30/F60 (Frosted)

Two-piece mounting tube; base (clear) with cover (frosted) for linear applications. Frosted diffusion levels, 10%, 30% or 60%. Available in 4' lengths.

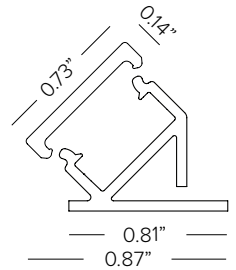

DL-C-45-MCH-4 (Base, REQUIRED)

45° mounting base (white) for 45° mounted linear applications. Available in 4' lengths.

DL-C-45-CVR-4-C (Cover, Clear)

DL-C-45-CVR-4-F10/F30/F60 (Cover, Frosted)

45° mounting base cover. Available in 4' lengths.

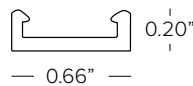

DL-MCHAN-8

Linear Mounting profile. Available in 8' lengths.

SURFACE PROFILES



P01B-S-PF-300

Aluminum profile with white PMMA screen for surface or recessed installation with limited width. Equipped with angle-joint accessory. Available in 118in (3M) lengths.

NOTE: 118 inch lengths must be shipped via freight only. For efficient shipping via UPS/Fedex, lengths can be cut to 59 inch upon request.



P01B-A-EC

3+3 pc silver end caps.

P01B-A-MC

4 Metal mounting clips.

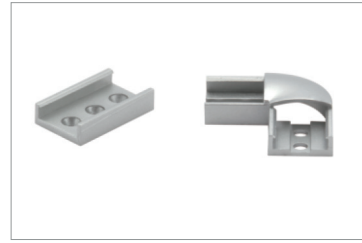
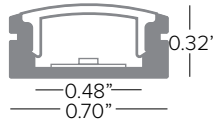

P01B-A-CP

3 pc silver color junction brackets.

P01B-A-CP90

3 pc silver color 90° junction brackets.

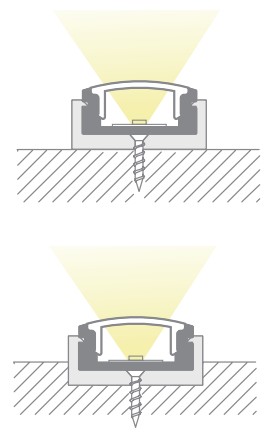

P02B-S-PF-300

Aluminum profile with white PMMA screen for surface or recessed installation with limited width. Equipped with angle-joint accessory. Available in 118in (3M) lengths.

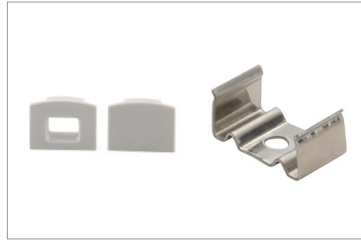

P02B-A-EC

3+3 pc silver end caps.

P02B-A-MC

4 Metal mounting clips.

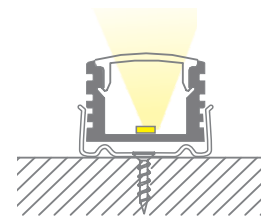
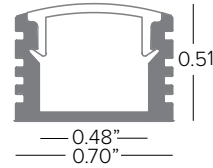

NOTE: 118 inch lengths must be shipped via freight only. For efficient shipping via UPS/Fedex, lengths can be cut to 59 inch upon request.



P03B-S-PF-300

Aluminum profile with polycarbonate lens with uniform light distribution for surface or recessed with suitable clips. Available in 118in (3M) lengths.



P03B-A-EC

3+3 pc silver end caps.

P03B-A-MC

3 Metal mounting clips.

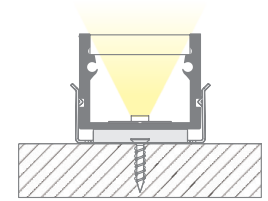
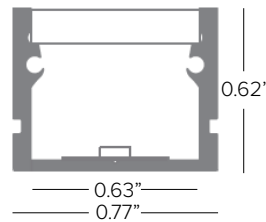

NOTE: 118 inch lengths must be shipped via freight only. For efficient shipping via UPS/Fedex, lengths can be cut to 59 inch upon request.

SURFACE PROFILES CONT.



P04B-S-PF-300

Aluminum profile with polycarbonate screen for surface or recessed with suitable clips. Available in 118in (3M) lengths.

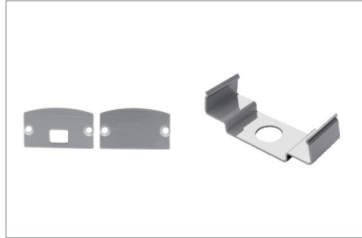

P04B-A-EC

3+3 pc metal end caps.

P04B-A-MC

3 Metal mounting clips.

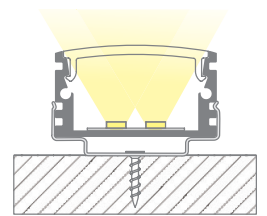
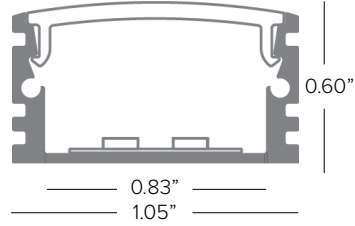

NOTE: 118 inch lengths must be shipped via freight only. For efficient shipping via UPS/Fedex, lengths can be cut to 59 inch upon request.



P03F-S-PF-300

Aluminum profile for surface or recessed corner with suitable clips. Available in 118in (3M) lengths.

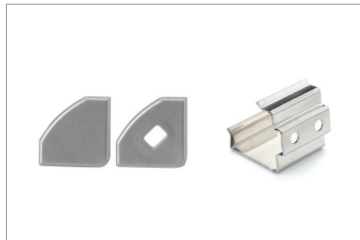

P03F-A-EC

3+3 pc end caps.

P03F-A-MC

3 Metal mounting clips.

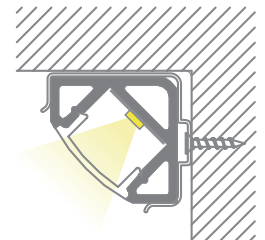
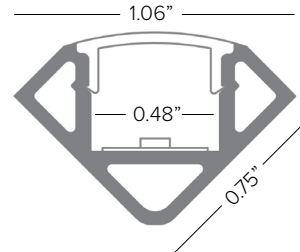

NOTE: 118 inch lengths must be shipped via freight only. For efficient shipping via UPS/Fedex, lengths can be cut to 59 inch upon request.



P04F-S-PF-300

Aluminum profile for surface in 90° angles with suitable clips. Available in 118in (3M) lengths.



P04F-A-EC

3+3 pc end caps.

P04F-A-MC

3 Metal mounting clips.

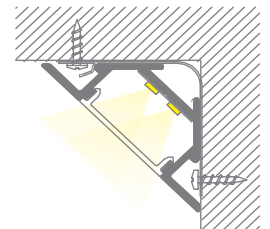
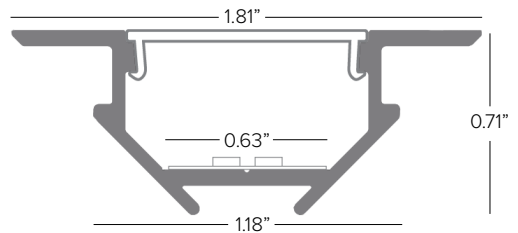

NOTE: 118 inch lengths must be shipped via freight only. For efficient shipping via UPS/Fedex, lengths can be cut to 59 inch upon request.

SURFACE PROFILES CONT.

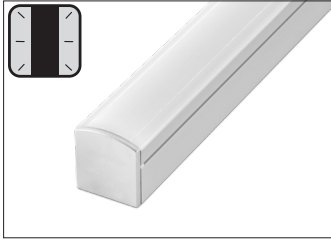

PRAP-U

Surface mount aluminum profile. Anodized aluminum rigid profile complete with opal translucent diffuser cover. Available in 79in (2M) lengths.

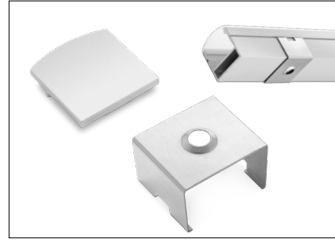

KTRAP-UEC

5 + 5 silver color end caps

KTPRU-CL

5 sets of clips



OR-DEV

Set of steel supports required with use of KTORDEV-U.

KTORDEV-U

Set of aluminum mounting heads required with use of OR-DEV.

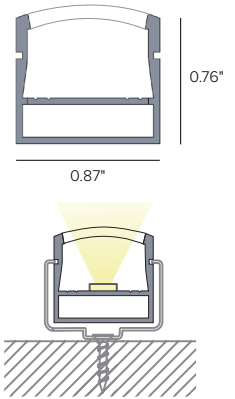

PRIN-U

Flush mount aluminum profile. Anodized aluminum rigid profile complete with opal translucent diffuser cover. Available in 79in (2M) lengths.

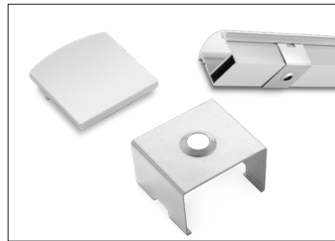

KTRPRIN-UEC

5 + 5 silver color end caps

KTPRU-CL

5 sets of clips

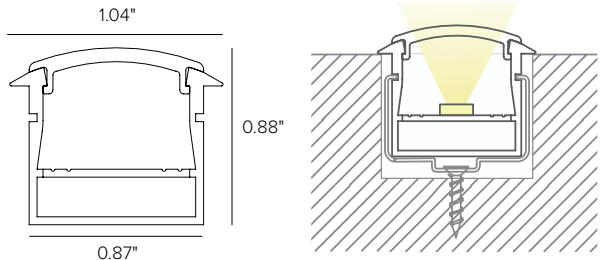

PRAN-U

45° aluminum profile. Anodized aluminum rigid profile complete with opal translucent diffuser cover. Available in 79in (2M) lengths.

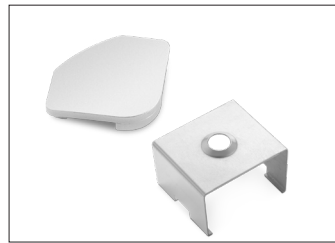

KTRPRAN-UEC

5 + 5 silver color end caps

KTRPRAN-UCL

5 sets of clips

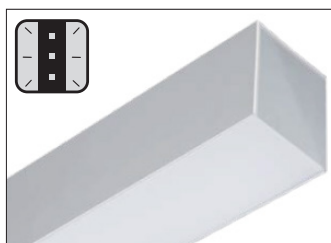
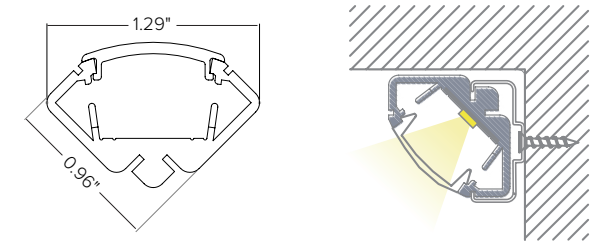

PRDES0

Aluminum profile for surface mount. Available in 4ft lengths.

PRDES0-SL

Rear support for surface mount.

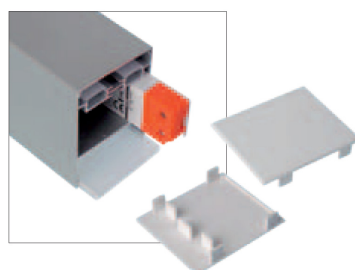

PRDES0-FL

Front screen in flat opal polycarbonate plate.

KTRDES0-FL

Set of two side end caps flat screen.

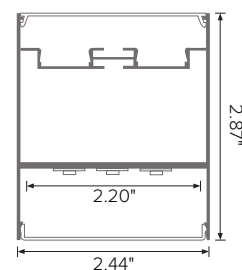

ADJUSTABLE PROFILES



P02C-S-PF-300

180° adjustable aluminum profile with wall washer function for surface with suitable clips. Available in 118in (3M) lengths.



P02C-A-EC

3+3 metal end caps.

P02C-A-OB

3 Metal adjustable brackets.

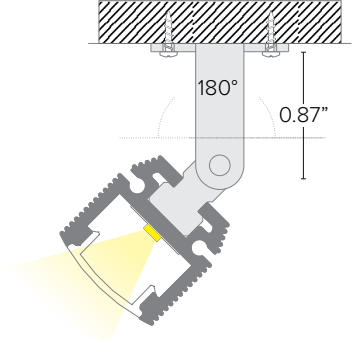
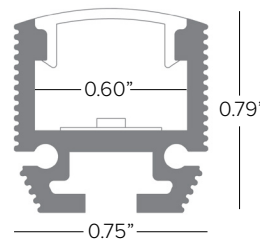

NOTE: 118 inch lengths must be shipped via freight only. For efficient shipping via UPS/Fedex, lengths can be cut to 59 inch upon request.



P03C-S-PF-300

180° adjustable aluminum profile with wall washer function for surface with suitable clips. Lens shape creates narrower spread. Available in 118in (3M) lengths.

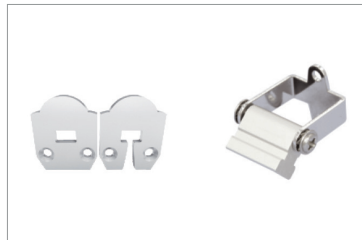

P03C-A-EC

3+3 metal end caps.

P03C-A-OB

6 Metal adjustable brackets.

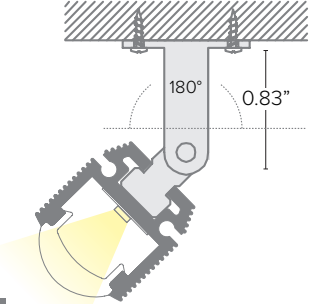
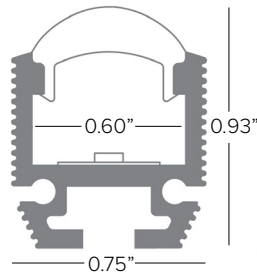

NOTE: 118 inch lengths must be shipped via freight only. For efficient shipping via UPS/Fedex, lengths can be cut to 59 inch upon request.



P04C-S-PF-300

Fixed profile at 30° with a wall washer function for surface installation. Available in 118in (3M) lengths.



P04C-A-EC

3+3 metal end caps.

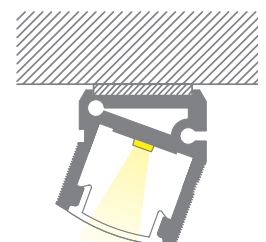
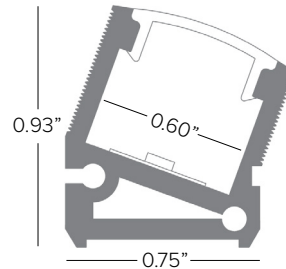

NOTE: 118 inch lengths must be shipped via freight only. For efficient shipping via UPS/Fedex, lengths can be cut to 59 inch upon request.

RECESSED PROFILES



P02H-S-PF-300

Aluminum profile with white PMMA screen for recessed installation with limited width. Available in 118in (3M) lengths.

NOTE: 118 inch lengths must be shipped via freight only. For efficient shipping via UPS/Fedex, lengths can be cut to 59 inch upon request.

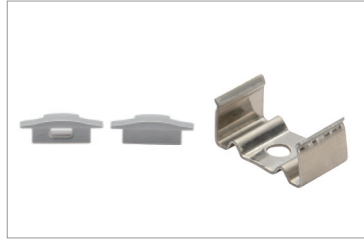

P02H-A-EC

3+3 pc silver end caps.

P02H-A-MC

3 Metal mounting clips.



P02H-A-CP

3 pc silver junction brackets.

P02H-A-CP90

3 junction brackets with 90° angle.

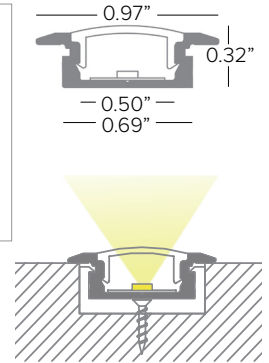

P03E-S-PF-300

Aluminum high impact walk over rated profile with white PMMA screen for recessed installation. Available in 118in (3M) lengths.



P03E-A-EC

3+3 pc end caps.

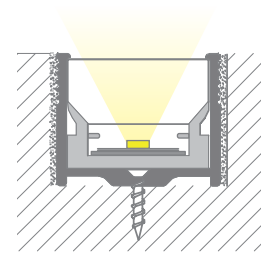
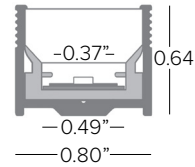

NOTE: 118 inch lengths must be shipped via freight only. For efficient shipping via UPS/Fedex, lengths can be cut to 59 inch upon request.



PRINTC-G

Rigid high impact resistant PMMA profile complete with a white plastic diffuser lensed channel for recessed walk over installation. Complete with track for easy strip insertion. Available in 3.28ft (1M) lengths.



KTRPRINTC-G

2+2 PC end caps

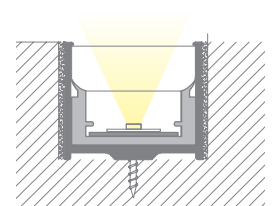
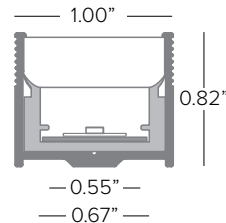

RECESSED PROFILES CONT.



PRINTC-GUS

Rigid high impact resistant PMMA profile complete with two part white plastic diffuser lens and aluminum channel for surface or recessed mounting. Available in 3.28ft (1M) lengths.



KTRPRINTC-G

2+2 PC end caps

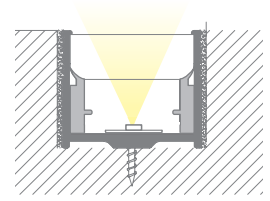
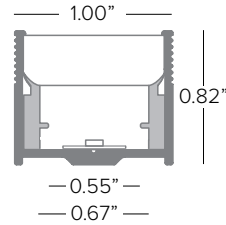

P04H-S-PF-300

Aluminum profile with white polycarbonate screen for recessed installation. Available in 118in (3M) lengths.

NOTE: 118 inch lengths must be shipped via freight only. For efficient shipping via UPS/Fedex, lengths can be cut to 59 inch upon request.



P04H-A-EC

3+3 pc silver end caps.

P04H-A-MC

3 Metal mounting clips.



P04H-A-FS

3 pc metal ceiling attachment springs.

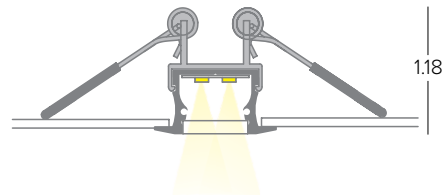
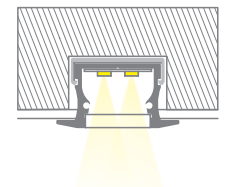
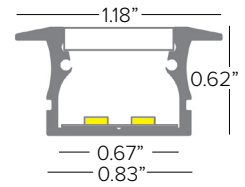

P08D-S-PF-300

Aluminum profile with white PMMA screen for recessed installation. Available in 118in (3M) lengths.

Max of (2) strips per profile.

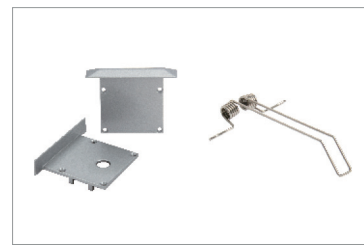

P08D-A-EC

3+3 pc silver end caps.

P08D-A-SP

3 pc metal ceiling attachment springs.

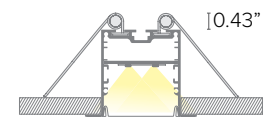
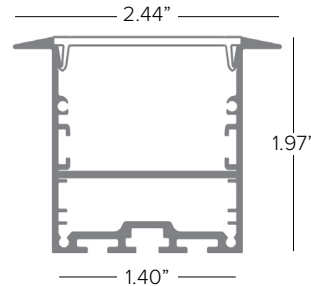

NOTE: 118 inch lengths must be shipped via freight only. For efficient shipping via UPS/Fedex, lengths can be cut to 59 inch upon request.

SUSPENSION PROFILES



P07A-S-PF-300

Aluminum profile with white polycarbonate screen for surface or suspension installation. Available in 118in (3M) lengths.

NOTE: 118 inch lengths must be shipped via freight only. For efficient shipping via UPS/Fedex, lengths can be cut to 59 inch upon request.

Max of (3) strips per profile.



P07A-A-EC

3+3 pc white end caps.

P07A-A-MC

6 Metal mounting clips.
(One set recommended for every 4ft)



P07A-A-FS

3 pc metal suspension cables

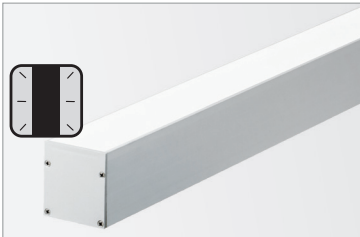
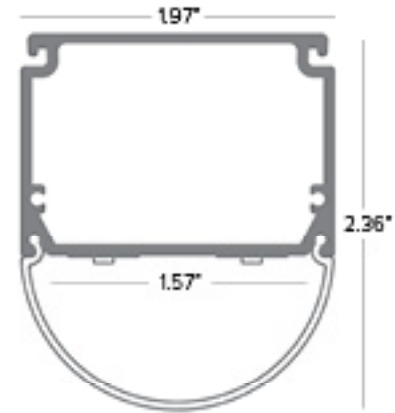

P01L-S-PF-300

Aluminum profile with white polycarbonate screen for suspension installation. Available in 118in (3M) lengths.

NOTE: 118 inch lengths must be shipped via freight only. For efficient shipping via UPS/Fedex, lengths can be cut to 59 inch upon request.

Max of (3) strips per profile.



P01L-A-EC

3+3 pc silver end caps.



P01L-A-FS

3 pc metal suspension cables.

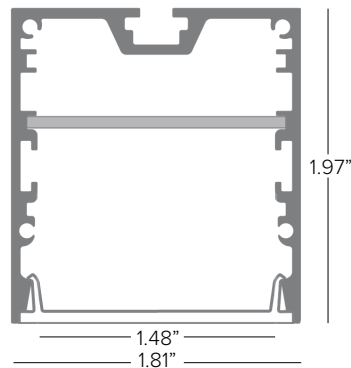
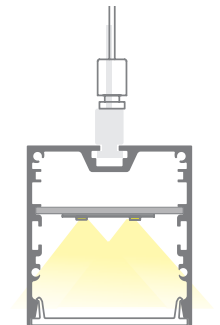

DECORATIVE PROFILES



P06A-S-PF-300

Aluminum profile with white PMMA screens for wall installation with wall washer effect upwards and downwards. Available in 118in (3M) lengths.

Max of (1) strip per profile direction.

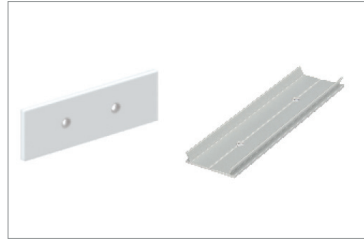

P06A-A-EC

3+3 pc silver end caps.

P06A-A-MC

1 set of metal brackets.

NOTE: 118 inch lengths must be shipped via freight only. For efficient shipping via UPS/Fedex, lengths can be cut to 59 inch upon request.

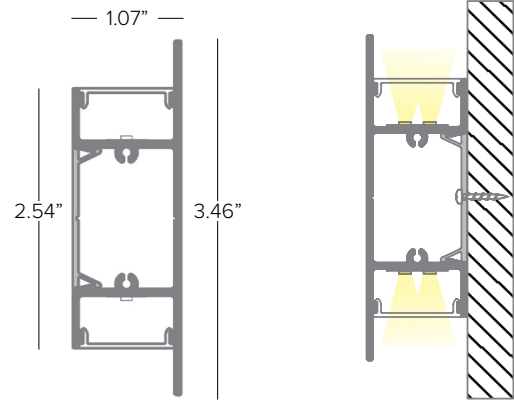

Power Supply (REQUIRED)	Type	Wattage	Input/Output Voltage	Dimmable	IP Rating	Output	Dimensions
DEDD1001244CDMX	ELECTRONIC ADDRESSABLE DMX DRIVER	100W	120-277V / 24V	DMX CONTROL 4 CHANNEL	NEMA1 ENCLOSURE	UL CLASS 2	12" x 12" x 4" ¹
DEDD2002244CDMX	ELECTRONIC ADDRESSABLE DMX DRIVER	2X100W	120-277V / 24V	DMX CONTROL 4 CHANNEL	NEMA1 ENCLOSURE	UL CLASS 2	12" x 12" x 4" ¹
DEDDxxxDMX consult factory	ELECTRONIC ADDRESSABLE DMX DRIVER STANDALONE, UL LISTED ENCLOSURE PROVIDED BY OTHERS	consult factory	120-277V / 24V	DMX DIMMING	N/A	UR CLASS 2	consult factory

¹ Dimensions include enclosure with mounting bracket.

* Constant voltage drivers 50/60HZ, voltage regulated with short circuit protection. Operating temperature -40 C- 80° C

* Installation of power supply must be compliant to Class 2 installation standards. Refer to NEC and local building code requirements.

MAXIMUM INTERCONNECTED TAPE LENGTH PER DRIVER

Fixture Wattage	Driver Wattage							
	40W	60W	96W	90W	2X90W	3X90W	100W	2X100
4.4W/ft	7FT	10FT	17FT	16FT	(2) 16FT	(3) 16FT	18FT	(2) 18FT

Controller (Optional)	Type	Application	Voltage	Listing	Dimensions	# Ouput Channels	Number of Zones	Number of Scenes
SWITCH20	RGBW Touch DMX512 Wall Control Panel with Sensitive Glass Touch Panel, White Finish	Indoor Only	12-24V DC	UL	4.73"H x 2.95"W x 1.15"D	12	3	1
TGDMXSLES AU9	Stand-alone DMX Programmable Controller with Easy to Use Software Interface	Indoor Only	5.5V DC	ETL, UL	5.3"W x 5.5"H x 1.9D	256	1	20



SWITCH20



TGDMXSLES AU9



a brand of TARGETTI

DURATAPE™ RGBW

IP20 INDOOR

PHOTOMETRY

DURATAPE RGBW		POLAR GRAPH
Fixture Power	4.4W	
Fixture Output	158.5Lm/Ft	
Kelvin Temp	RGBW	
Beam Spread	120°	
IMax	317cd/klm	
Efficacy	36 Lm/W	