



a brand of TARGETTI

DURATAPE™ RGBW PIXEL CONTROL

INDOOR IP20

KEY FEATURES

- DURATAPE PIXEL CONTROL allows each LED segment (4in or 6 quad chip LED's) to be independently controlled to create dynamic effects and lighting solutions.
- Sold per foot and manufactured to specified lengths with factory attached end preps.
- Features double sided substrate for optimum heat dissipation, minimizing voltage drop while increasing run lengths per power feed, standardizing electrical flow over entire length of the strip for maximum product reliability.
- Pre-assembled to specific lengths with various connector options for project requirements and efficient power configuration.
- Max continuous length: up to 16' per run
- Multiple DMX driver solutions available.

DIMENSIONAL DRAWINGS

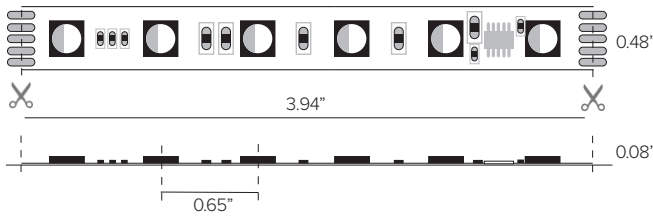

DETAILS

Spacing	0.65" OC LED Spacing
LEDs	18 Quad Chip LEDs per foot
Wattage	6.0W/ft
Color Temp	RGBW Quad Chip: Red 625nm / Green 520nm / Blue 450nm / 3000K Warm White
Color Consistency	Bin centered on the Planck curve with a 2 step MacAdam tolerance.
End Preps	Factory prepped end preps available (See Page 2)
Mounting	Includes installation-ready 3M tape adhesive for simplified installation directly to mounting channel or application surface
Installation	Optional mounting channels and clips, protective lens covers, thermal channels and heat transfer tape for optimal maintainance. Field trimmable every 4.00"
Power Supply	Listed Class 2 output, 24V DC DMX power supply required.
Certifications	cULus Class 2 Listed Tested in accordance with LM-79-08
Compliance	ROHS compliant
Warranty	5 year warranty

FIXTURE DATA

Model	Efficacy* Lm/Wt	Lm/Ft	Wt/Ft
RGBW	14.2	85.4	6.0

LED DATA

Model	Wt/LED	Viewing Angle	Lifespan at 90% drive
RGBW 6.0W/ft	0.33W	120°	40,000hrs

* LEDs operating at 90% of LED manufacturers maximum current rating.

PRODUCT CODE	TYPE	WATTAGE	IP RATING	LED COLOR	VOLTAGE	+	END PREP	+	MOUNTING	+	POWER SUPPLY
DL — Duratape™	PX — Pixel Control	60 — 6.0 W/ft	I — Indoor IP20	RGBW — Red: 625nm, Green: 520nm Blue: 450nm + 3000K Warm White	24 — 24VDC						

END PREPS AND CONNECTORS

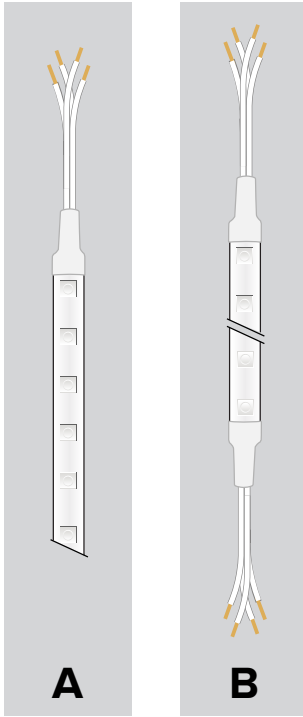

REQUIRED END PREPS:

(One required for each run of tape)

A

07UIDMX1CBL1: END PREP

Factory attached single lead wire prep two conductor shielded DMX cable and two conductor 18ga power cable. 24" Lead wire/dead end allows for connection to power at lead end and field trim of Duratape product at the other end.

07UIDMX1ADDCBL1-XX: ADDITIONAL LEAD WIRE

Additional lead wire purchased per foot and factory attached to specified run leads. Lead wire can be field cut to desired length.

B

07UIDMX1CBL2: END PREP

Factory attached double ended lead wire prep two conductor shielded DMX cable and two conductor 18ga power cable. 24" lead wire at both ends. One end can be used for power connectivity while the other end can be used for interconnection to run to an additional length of Duratape. **Caution: Pay attention to max run lengths and voltage drops from total lead/fold wire lengths.**

07UIDMX1ADDCBL2-XX: ADDITIONAL LEAD WIRE

Additional lead wire purchased per foot and factory attached to specified run leads. Lead wire can be field cut to desired length.

PROFILE OPACITY LEVEL KEY:



Uniform
Direct View



Blended
Direct / Indirect View



Pixelated
Indirect View

SURFACE PROFILES

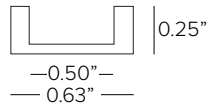
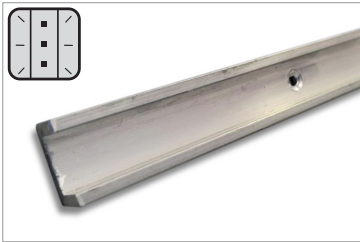

DL-ALUM-U-8

Low profile aluminum U-Profile for linear run lengths. Available in 8ft lengths.

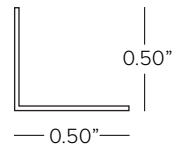
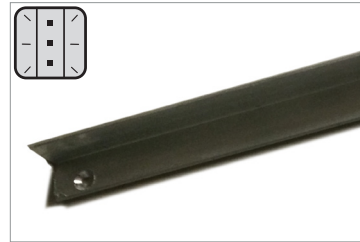

DL-ALUM-L-8

Aluminum L-Profile 1/2" x 1/2" for linear run lengths. Duratape can be mounted at either 0° or 90° mounting positions. Available in 8ft lengths.

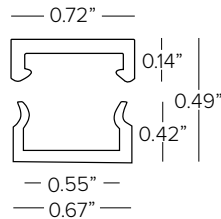

DL-W-2PC-C (Clear)

DL-W-2PC-F10/F30/F60 (Frosted)

Two-piece mounting tube; base (clear) with cover (frosted) for linear applications. Frosted diffusion levels, 10%, 30% or 60%. Available in 4' lengths.

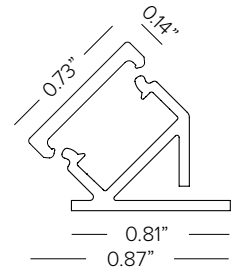

DL-C-45-MCH-4 (Base, REQUIRED)

45° mounting base (white) for 45° mounted linear applications. Available in 4' lengths.

DL-C-45-CVR-4-C (Cover, Clear)

DL-C-45-CVR-4-F10/F30/F60 (Cover, Frosted)

45° mounting base cover. Available in 4' lengths.

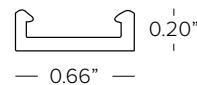

DL-MCHAN-8

Linear Mounting profile. Available in 8' lengths.

SURFACE PROFILES



P01B-S-PF-300

Aluminum profile with white PMMA screen for surface or recessed installation with limited width. Equipped with angle-joint accessory. Available in 118in (3M) lengths.

NOTE: 118 inch lengths must be shipped via freight only. For efficient shipping via UPS/Fedex, lengths can be cut to 59 inch upon request.

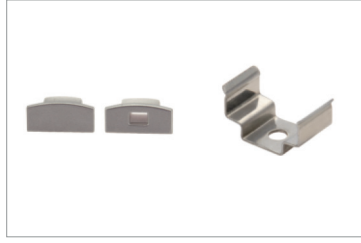

P01B-A-EC

3+3 pc silver end caps.

P01B-A-MC

4 Metal mounting clips.

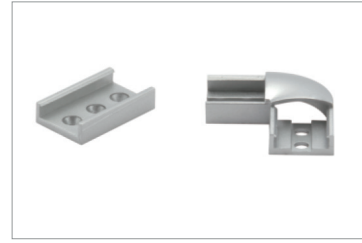
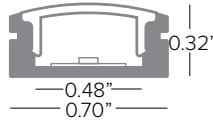

P01B-A-CP

3 pc silver color junction brackets.

P01B-A-CP90

3 pc silver color 90° junction brackets.

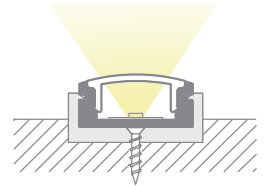
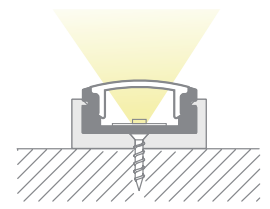

P02B-S-PF-300

Aluminum profile with white PMMA screen for surface or recessed installation with limited width. Equipped with angle-joint accessory. Available in 118in (3M) lengths.

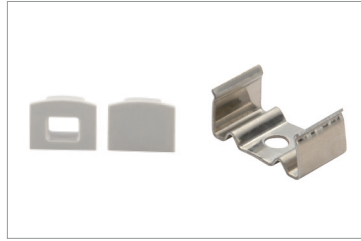

P02B-A-EC

3+3 pc silver end caps.

P02B-A-MC

4 Metal mounting clips.

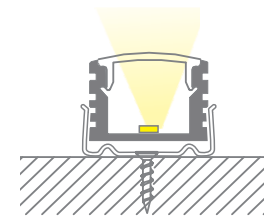
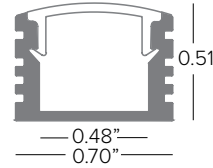

NOTE: 118 inch lengths must be shipped via freight only. For efficient shipping via UPS/Fedex, lengths can be cut to 59 inch upon request.



P03B-S-PF-300

Aluminum profile with polycarbonate lens with uniform light distribution for surface or recessed with suitable clips. Available in 118in (3M) lengths.



P03B-A-EC

3+3 pc silver end caps.

P03B-A-MC

3 Metal mounting clips.

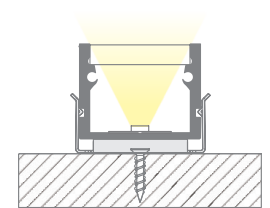
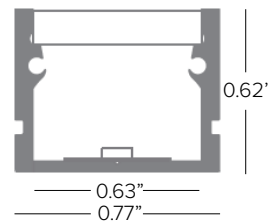

NOTE: 118 inch lengths must be shipped via freight only. For efficient shipping via UPS/Fedex, lengths can be cut to 59 inch upon request.

SURFACE PROFILES CONT.



P04B-S-PF-300

Aluminum profile with polycarbonate screen for surface or recessed with suitable clips. Available in 118in (3M) lengths.

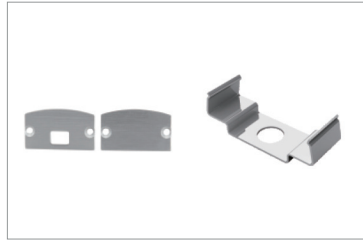

P04B-A-EC

3+3 pc metal end caps.

P04B-A-MC

3 Metal mounting clips.

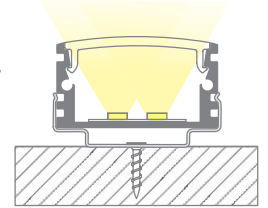
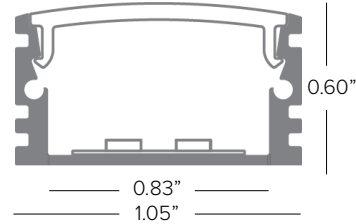

NOTE: 118 inch lengths must be shipped via freight only. For efficient shipping via UPS/Fedex, lengths can be cut to 59 inch upon request.



P03F-S-PF-300

Aluminum profile for surface or recessed corner with suitable clips. Available in 118in (3M) lengths.

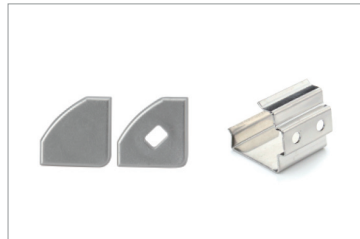

P03F-A-EC

3+3 pc end caps.

P03F-A-MC

3 Metal mounting clips.

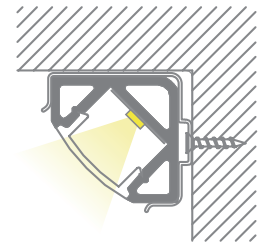
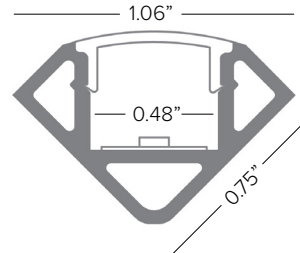

NOTE: 118 inch lengths must be shipped via freight only. For efficient shipping via UPS/Fedex, lengths can be cut to 59 inch upon request.



P04F-S-PF-300

Aluminum profile for surface in 90° angles with suitable clips. Available in 118in (3M) lengths.



P04F-A-EC

3+3 pc end caps.

P04F-A-MC

3 Metal mounting clips.

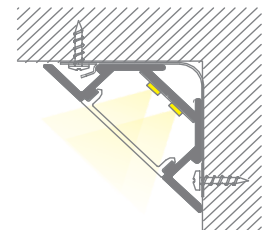
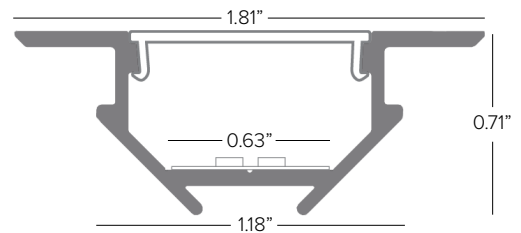

NOTE: 118 inch lengths must be shipped via freight only. For efficient shipping via UPS/Fedex, lengths can be cut to 59 inch upon request.

SURFACE PROFILES CONT.



PRAP-U

Surface mount aluminum profile. Anodized aluminum rigid profile complete with opal translucent diffuser cover. Available in 79in (2M) lengths.

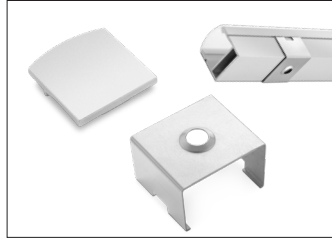

KTPRAP-UEC

5 + 5 silver color end caps

KTPRU-CL

5 sets of clips

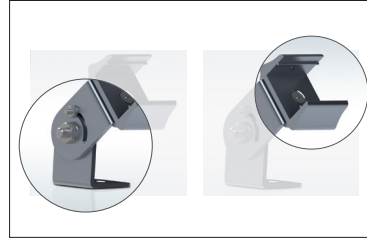

OR-DEV

Set of steel supports required with use of KTORDEV-U.

KTORDEV-U

Set of aluminum mounting heads required with use of OR-DEV.

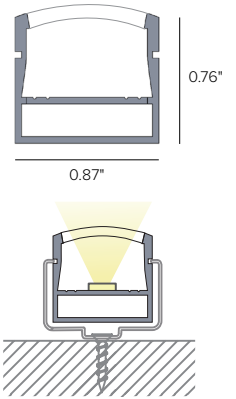

PRIN-U

Flush mount aluminum profile. Anodized aluminum rigid profile complete with opal translucent diffuser cover. Available in 79in (2M) lengths.

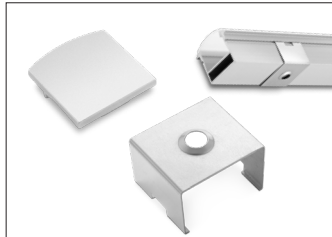

KTPRIN-UEC

5 + 5 silver color end caps

KTPRU-CL

5 sets of clips

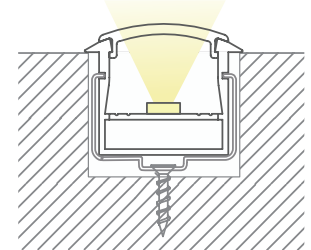
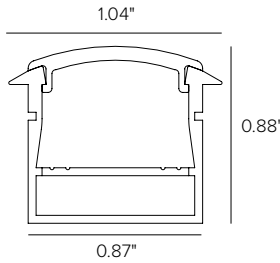

PRAN-U

45° aluminum profile. Anodized aluminum rigid profile complete with opal translucent diffuser cover. Available in 79in (2M) lengths.



KTPRAN-UEC

5 + 5 silver color end caps

KTPRAN-UCL

5 sets of clips

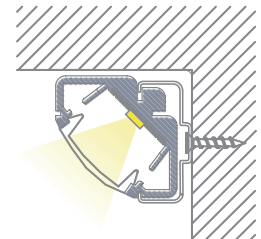
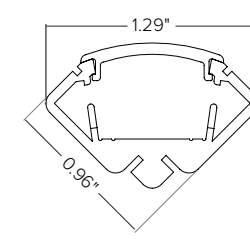

SURFACE PROFILES CONT.

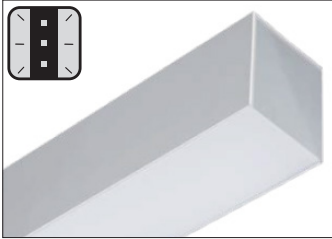

PRDESO

Aluminum profile for surface mount. Available in 4ft lengths.

PRDESO-SL

Rear support for surface mount.

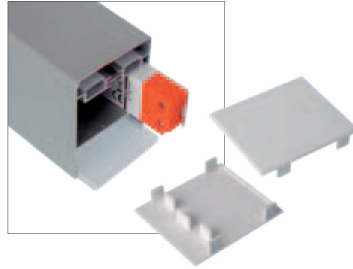

PRDESO-FL

Front screen in flat opal polycarbonate plate.

KTRDESO-FL

Set of two side end caps flat screen.

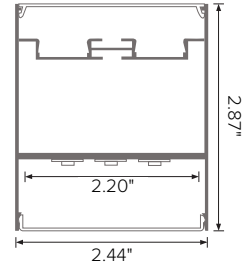

ADJUSTABLE PROFILES



P02C-S-PF-300

180° adjustable aluminum profile with wall washer function for surface with suitable clips. Available in 118in (3M) lengths.



P02C-A-EC

3+3 metal end caps.

P02C-A-OB

3 Metal adjustable brackets.

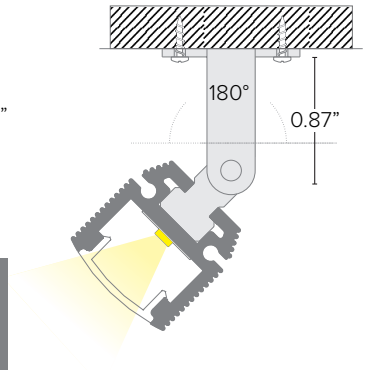
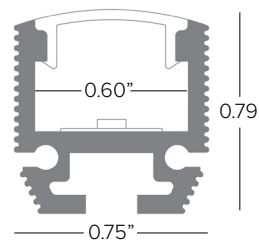

NOTE: 118 inch lengths must be shipped via freight only. For efficient shipping via UPS/Fedex, lengths can be cut to 59 inch upon request.

ADJUSTABLE PROFILES CONT.



P03C-S-PF-300

180° adjustable aluminum profile with wall washer function for surface with suitable clips. Lens shape creates narrower spread. Available in 118in (3M) lengths.

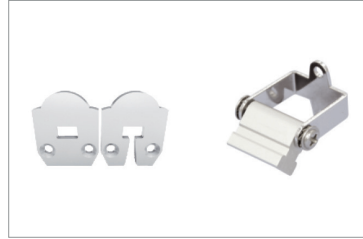

P03C-A-EC

3+3 metal end caps.

P03C-A-OB

6 Metal adjustable brackets.

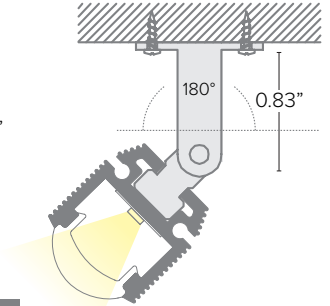
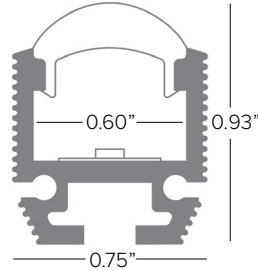

NOTE: 118 inch lengths must be shipped via freight only. For efficient shipping via UPS/Fedex, lengths can be cut to 59 inch upon request.



P04C-S-PF-300

Fixed profile at 30° with a wall washer function for surface installation. Available in 118in (3M) lengths.



P04C-A-EC

3+3 metal end caps.

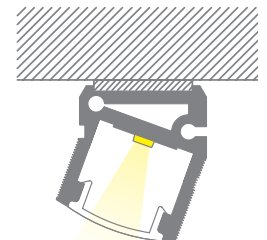
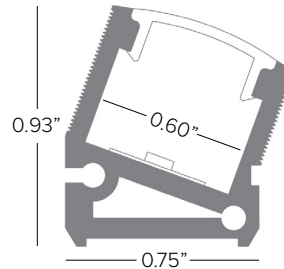

NOTE: 118 inch lengths must be shipped via freight only. For efficient shipping via UPS/Fedex, lengths can be cut to 59 inch upon request.

RECESSED PROFILES



P02H-S-PF-300

Aluminum profile with white PMMA screen for recessed installation with limited width. Available in 118in (3M) lengths.

NOTE: 118 inch lengths must be shipped via freight only. For efficient shipping via UPS/Fedex, lengths can be cut to 59 inch upon request.

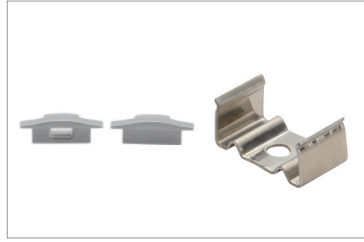

P02H-A-EC

3+3 pc silver end caps.

P02H-A-MC

3 Metal mounting clips.



P02H-A-CP

3 pc silver junction brackets.

P02H-A-CP90

3 junction brackets with 90° angle.

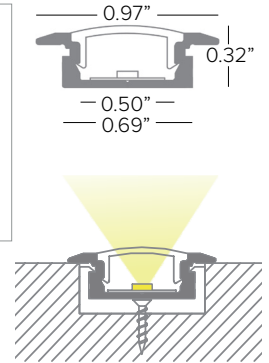

P03E-S-PF-300

Aluminum high impact walk over rated profile with white PMMA screen for recessed installation. Available in 118in (3M) lengths.

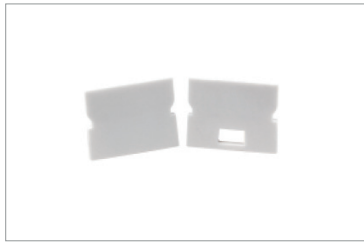

P03E-A-EC

3+3 pc end caps.

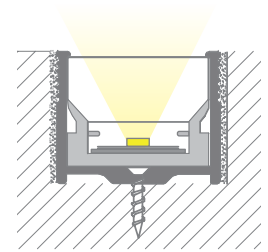
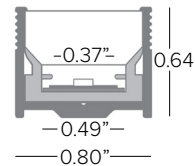

NOTE: 118 inch lengths must be shipped via freight only. For efficient shipping via UPS/Fedex, lengths can be cut to 59 inch upon request.



PRINTC-G

Rigid high impact resistant PMMA profile complete with a white plastic diffuser lensed channel for recessed walk over installation. Complete with track for easy strip insertion. Available in 3.28ft (1M) lengths.



KTRPRINTC-G

2+2 PC end caps

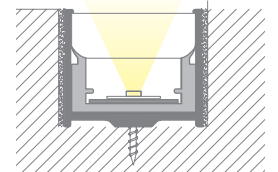
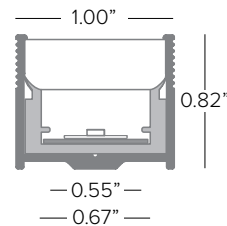

RECESSED PROFILES CONT.



PRINTC-GUS

Rigid high impact resistant PMMA profile complete with two part white plastic diffuser lens and aluminum channel for surface or recessed mounting. Available in 3.28ft (1M) lengths.

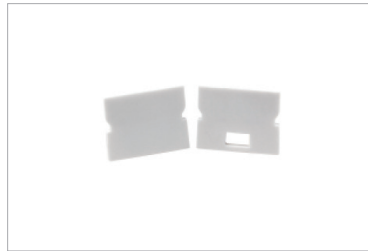

KPRINTC-G

2+2 PC end caps

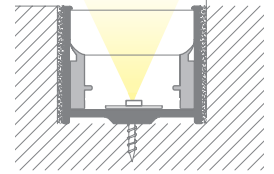
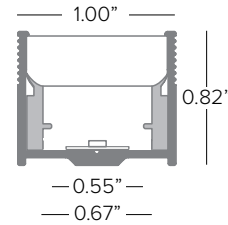

P04H-S-PF-300

Aluminum profile with white polycarbonate screen for recessed installation. Available in 118in (3M) lengths.

NOTE: 118 inch lengths must be shipped via freight only. For efficient shipping via UPS/Fedex, lengths can be cut to 59 inch upon request.



P04H-A-EC

3+3 pc silver end caps.

P04H-A-MC

3 Metal mounting clips.



P04H-A-FS

3 pc metal ceiling attachment springs.

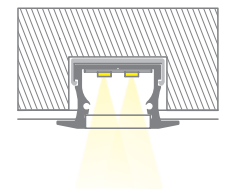
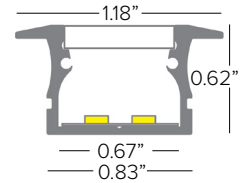
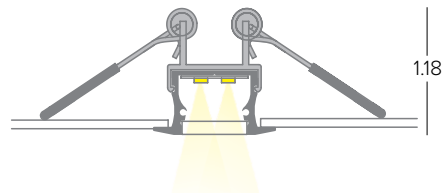

P08D-S-PF-300

Aluminum profile with white PMMA screen for recessed installation. Available in 118in (3M) lengths.

Max of (2) strips per profile.



P08D-A-EC

3+3 pc silver end caps.

P08D-A-SP

3 pc metal ceiling attachment springs.

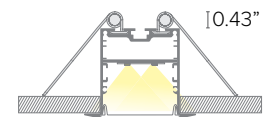
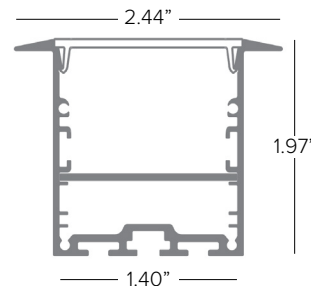

NOTE: 118 inch lengths must be shipped via freight only. For efficient shipping via UPS/Fedex, lengths can be cut to 59 inch upon request.

SUSPENSION PROFILES

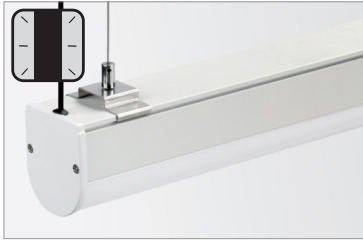

P07A-S-PF-300

Aluminum profile with white polycarbonate screen for surface or suspension installation. Available in 118in (3M) lengths.

NOTE: 118 inch lengths must be shipped via freight only. For efficient shipping via UPS/Fedex, lengths can be cut to 59 inch upon request.

Max of (3) strips per profile.

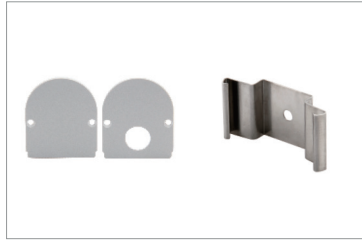

P07A-A-EC

3+3 pc white end caps.

P07A-A-MC

6 Metal mounting clips.
(One set recommended for every 4ft)



P07A-A-FS

3 pc metal suspension cables.

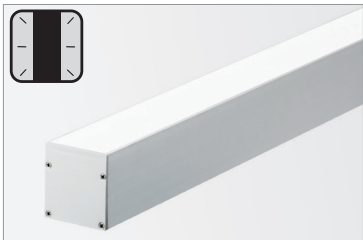
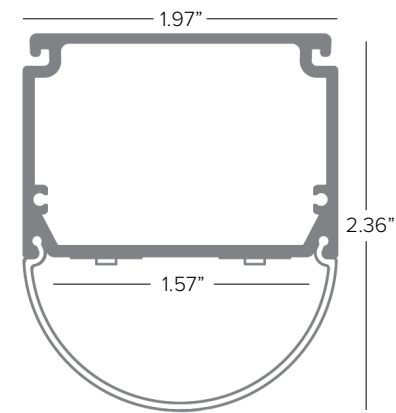
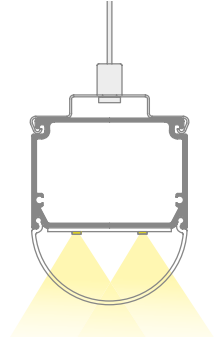

P01L-S-PF-300

Aluminum profile with white polycarbonate screen for suspension installation. Available in 118in (3M) lengths.

NOTE: 118 inch lengths must be shipped via freight only. For efficient shipping via UPS/Fedex, lengths can be cut to 59 inch upon request.

Max of (3) strips per profile.



P01L-A-EC

3+3 pc silver end caps.



P01L-A-FS

3 pc metal suspension cables.

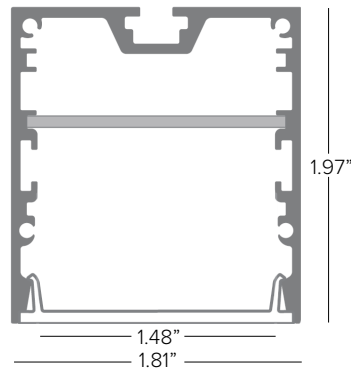
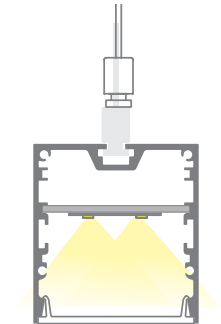

DECORATIVE PROFILES



P06A-S-PF-300
Aluminum profile with white PMMA screens for wall installation with wall washer effect upwards and downwards. Available in 118in (3M) lengths.

Max of (1) strip per profile direction.

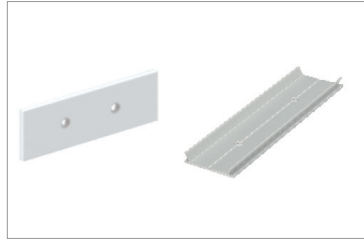

P06A-A-EC
3+3 pc silver end caps.
P06A-A-MC
1 set of metal brackets.

NOTE: 118 inch lengths must be shipped via freight only. For efficient shipping via UPS/Fedex, lengths can be cut to 59 inch upon request.

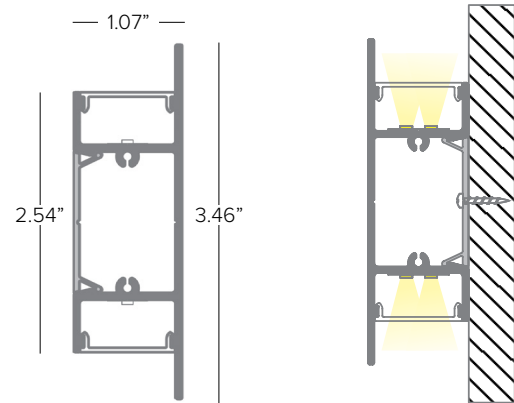

PLASTER RECESSED PROFILES



PRINC-G
Flush Mount aluminum profile for installation in plasterboard. Complete with white lens. Available in 79in (2M) lengths.

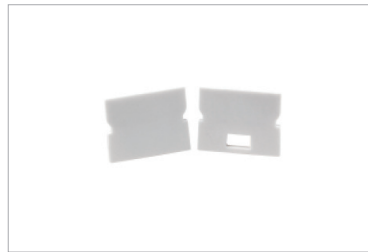

KTRINC-G
2+2 PC end caps

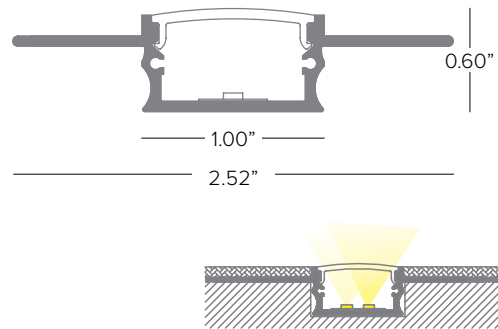

Power Supply (REQUIRED)	Type	Wattage	Input/Output Voltage	Dimmable	IP Rating	Output	Dimensions
DMLE301242UD	EMCOD MLE ELECTRONIC UNIVERSAL DIMMING DRIVER WITH WIRING COMPARTMENT.	30W	120-277V / 24V	MLV / ELV / 0-10V / TRIAC	NEMA3R ENCLOSURE	UL CLASS 2	4.47" X 6.79" X 1.38"
DMLE601242UD	EMCOD MLE ELECTRONIC UNIVERSAL DIMMING DRIVER WITH WIRING COMPARTMENT.	60W	120-277V / 24V	MLV / ELV / 0-10V / TRIAC	NEMA3R ENCLOSURE	UL CLASS 2	4.47" X 6.79" X 1.38"
DMLE961242UD	EMCOD MLE ELECTRONIC UNIVERSAL DIMMING DRIVER WITH WIRING COMPARTMENT.	96W	120-277V / 24V	MLV / ELV / 0-10V / TRIAC	NEMA3R ENCLOSURE	UL CLASS 2	5.16" X 7.73" X 1.54"
DMLE1922242UD	EMCOD MLE ELECTRONIC UNIVERSAL DIMMING DRIVER WITH WIRING COMPARTMENT.	2X96W	120-277V / 24V	MLV / ELV / 0-10V / TRIAC	NEMA3R ENCLOSURE	UL CLASS 2	5.04" X 10.94" X 1.81"
DMLE2882242UD	EMCOD MLE ELECTRONIC UNIVERSAL DIMMING DRIVER WITH WIRING COMPARTMENT.	3X96W	120-277V / 24V	MLV / ELV / 0-10V / TRIAC	NEMA3R ENCLOSURE	UL CLASS 2	5.04" X 10.94" X 1.81"

¹ Dimensions include enclosure with mounting bracket.

* Constant voltage drivers 50/60HZ, voltage regulated with short circuit protection. Operating temperature -40 C- 80° C

* Installation of power supply must be compliant to Class 2 installation standards. Refer to NEC and local building code requirements.

MAXIMUM INTERCONNECTED TAPE LENGTH PER DRIVER

Fixture Wattage	Driver Wattage					
	40W	60W	96W	90W	2X90W	3X90W
6W/ft	5FT	8FT	12FT	12FT	(2) 12FT	(3) 12FT

Controllers:

Part No.	Type	Application	Voltage	Listing	Dimensions	Channels	Zones	Scenes
TGDMXSLESAU9	Stand-alone DMX 1/2 Universe Programmable Controller with Easy to Use Software Interface	Indoor Only	5.5V DC	ETL, UL	5.3"W x 5.5"H x 1.9"D	256	1	20
TGDMXSLESAU11	Nicolaudie Slesa smart DMX interface, 2 DMX 512 universes, intuitive backlit keyboard programmable controller with easy to use software interface.	Indoor	5VDC 120V AC (Plug in power supply included)	ETL	6.3" x 3.6" x 1.8"	1024	5	99
TGDMXSTICKDE3B	Nicolaudie intelligent wall control keypad with glass touch sensitive graphic display, stand-alone DMX 512, 2 universe programmable controller with easy to use software interface. Black finish.	Indoor	6-7V DC 120V AC (Plug in power supply included)	ETL	5.8" x 4.2" x 0.5"	1024	10	500
TGDMXSTICKDE3W	Nicolaudie intelligent control keypad with glass touch sensitive graphic display, stand-alone DMX 512, 2 universe programmable controller with easy to use software interface. White finish.	Indoor	6-7V DC 120V AC (Plug in power supply included)	ETL	5.8" x 4.2" x 0.5"	1024	10	500



TGDMXSLESAU9



TGDMXSLESAU11



TGDMXSTICKDE3



a brand of TARGETTI

DURATAPE™ RGBW PIXEL CONTROL

INDOOR IP20

PHOTOMETRY

DURATAPE PIXEL CONTROL		POLAR GRAPH
Fixture Power	6.0W	
Fixture Output	85.4Lm	
Kelvin Temp	RGBW	
Beam Spread	120°	
IMax	316cd/klm	
Efficacy	14.2 Lm/W	