



a brand of TARGETTI

DURATAPE™ TUNABLE CCT

IP65 OUTDOOR

KEY FEATURES

- According to Human Centric Lighting principles, the Kelvin temperature of light has a profound influence on people's emotional state. DURATAPE TUNABLE CCT is fundamental for dynamic white light management to improve the overall environment and the wellbeing of people. Dynamic white light is essential in environments where people remain for a long period of time, such as offices and schools. It is equally useful to create different atmospheres within the same environment such as restaurants and hospitality environments.
- DURATAPE TUNABLE CCT allows for full dynamic control of white light blends ranging from cool to warm kelvin tones, with dimming control independent of color. DURATAPE TUNABLE CCT offers two white color temperature ranges from 1800K to 3500K or from 2700K to 6500K.
- Features 3-circuit, double layer of copper sided substrate, for optimum heat dissipation, minimizing voltage drop while increasing run lengths per power feed, standardizing electrical flow over entire length of the strip for maximum product reliability.
- Features double sided solder points for maximum conductivity and durability.
- Sold per foot and manufacturer pre-assembled to specific lengths with various connector options for project requirements and efficient power configurations.
- Max continuous length: up to 16' per run
- Multiple control options available.



DETAILS

Spacing	0.33" OC Paired LED Spacing
LEDs	68 LEDs per foot arranged as tight pairs of bi-colored sets
Color Temp	1800K – 3500K 2700K – 6500K
Color Consistency	Bin centered on the Planck curve with a 2 step MacAdam tolerance.
CRI	Ra+90
End Preps	Factory prepped end preps available (See Page 2)
Mounting	Includes installation-ready 3M tape adhesive for simplified installation directly to mounting channel or application surface
Installation	Optional mounting channels and clips, protective lens covers, thermal channels for optimal maintainance. Field trimmable every 2"
Power Supply	Listed Class 2 output, 24 VDC power supply required
Listing	cULus Class 2 Listed E471161 Tested in accordance with LM-79-08 Energy efficient for California installations.
Compliance	ROHS compliant MRI Safe, driver to be mounted outside of MRI room. To be use with plastic or aluminum profiles only. To be installed with adhesive or MRI safe hardware only, no factory provided mounting hardware to be used.
Warranty	5 year warranty

DIMENSIONAL DRAWINGS

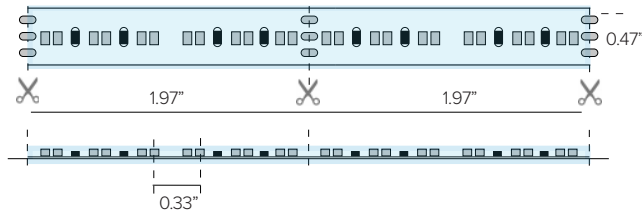

DESIGN INSTALLATION EXAMPLES

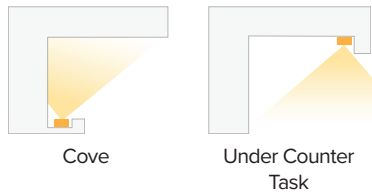

FIXTURE DATA

Model	Efficacy* Lm/Wt	Lm/Ft	Wt/Ft
T1 – 3500K	71	305	4.3
T2 – 6500K	77	329	4.3

* Meets Title 24 High efficacy rating.

LED DATA

Model	Wt/LED	Viewing Angle	Lifespan at 90% drive
Tunable CCT	0.06W	120°	50,000hrs

* LEDs operating at 90% of LED manufacturers maximum current rating.

PRODUCT CODE	INTENSITY	WATTAGE	IP RATING	COLOR TEMP	CRI	VOLTAGE	+	END PREP	+	MOUNTING	+	POWER SUPPLY
--------------	-----------	---------	-----------	------------	-----	---------	---	----------	---	----------	---	--------------

DL — Duratape™ TW — Tunable White 43 — 4.3 W/ft O — Outdoor IP65 T1 — 1800K – 3500K HC — +90 CRI 24 — 24 VDC
T2 — 2700K – 6500K

END PREPS AND CONNECTORS (REQUIRED) - Choose 1

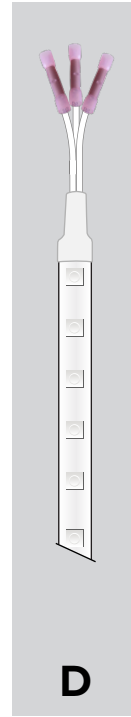

REQUIRED END PREPS:

(One required for each run of tape)

A

07UX3CBL1

Factory attached single lead wire prep. 24" Lead wire/dead end allows for connection to power at lead end and field trim of Duratape product at the other end.

07UX3ADDCBL-XX: ADDITIONAL LEAD WIRE

Additional lead wire purchased per foot and factory attached to specified run leads. Lead wire can be field cut to desired length.

B

07UX3CBL2

Factory attached double ended lead wire prep. 24" lead wire at both ends. One end can be used for power connectivity while the other end can be used for interconnection to run to an additional length of Duratape. **Caution: Pay attention to max run lengths and voltage drops from total lead/fold wire lengths.**

07UX3ADDCBL-XX: ADDITIONAL LEAD WIRE

12" Additional lead wire purchased per foot and factory attached to specified run leads. Lead wire can be field cut to desired length.

C

07UX3FOLD CBL-XX

Wire fold (specified length). Wire folds are factory attached to Duratape to meet your specified installation requirements. Wire fold lengths available are 1", 2", 3", 4", 6", 12". Add length number to end of part number. **Caution: Pay attention to max run lengths and voltage drops from total lead/fold wire lengths.**

OPTIONAL CONNECTORS:

D

07UX3ADDCON

Additional connectors. Lead wire connectors 3/ea per connection.

PROFILE OPACITY LEVEL KEY:



Uniform
Direct View



Blended
Direct / Indirect View



Pixelated
Indirect View

CLIPS AND SURFACE PROFILES



DL-CLP-66

DuraTape ES plastic mounting clip, package of 10 each. Recommended quantities per use: Straight flat run aiming upward 12" O.C. (1/ft); Curved aiming upward or wall mounted straight 6" O.C. (2/ft); Wall mounted curved or ceiling mounted 3" O.C. (4/ft).

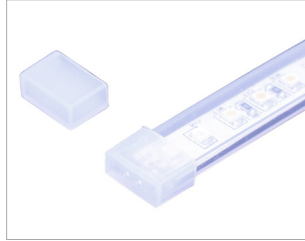

DL-EC

Optional silicone end cap for termination of IP66 tape, sold individually.

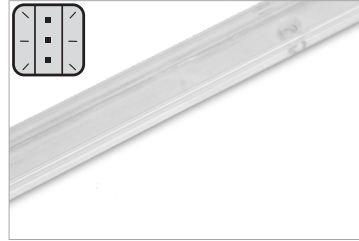

DL-MCHAN-8

Linear Mounting profile. Available in 8' lengths.

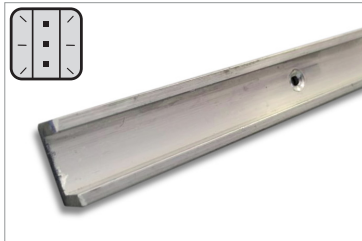
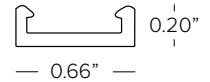

DL-ALUM-U-8

Low profile aluminum U-Profile for linear run lengths. Available in 8ft lengths.

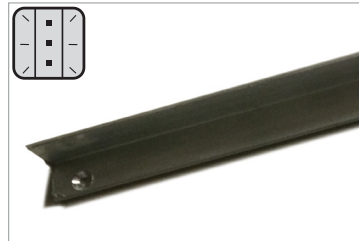
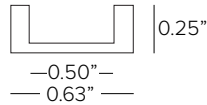

DL-ALUM-L-8

Aluminum L-Profile 1/2" x 1/2" for linear run lengths. DuraTape can be mounted at either 0° or 90° mounting positions. Available in 8ft lengths.

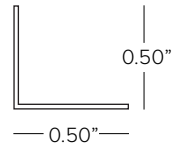

DL-W-2PC-C (Clear)

DL-W-2PC-F10/F30/F60 (Frosted)

Two-piece mounting tube; base (clear) with cover (frosted) for linear applications. Frosted diffusion levels, 10%, 30% or 60%. Available in 4' lengths.

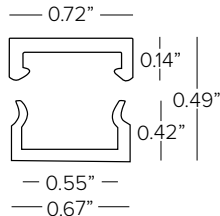

DL-W-45-MCH-4 (Base, REQUIRED)

45° mounting base (white) for 45° mounted linear applications. Available in 4' lengths.

DL-W-45-CVR-4-C (Clear)

45° mounting base cover. Available in 4' lengths.

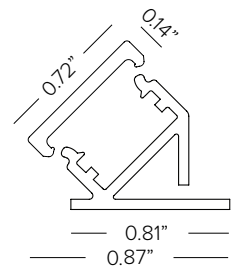

SURFACE PROFILES



P02B-S-PF-300
Aluminum profile with white PMMA screen for surface or recessed installation with limited width. Equipped with angle-joint accessory. Available in 118in (3M) lengths.



P02B-A-EC
3+3 pc silver end caps.
P02B-A-MC
4 Metal mounting clips.

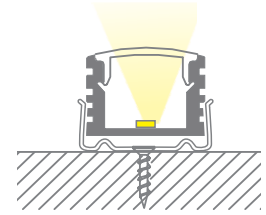
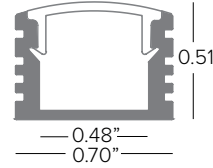

NOTE: 118 inch lengths must be shipped via freight only. For efficient shipping via UPS/Fedex, lengths can be cut to 59 inch upon request.

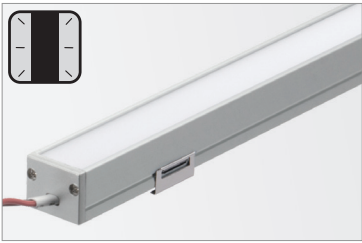

P03B-S-PF-300
Aluminum profile with polycarbonate lens with uniform light distribution for surface or recessed with suitable clips. Available in 118in (3M) lengths.



P03B-A-EC
3+3 pc silver end caps.
P03B-A-MC
3 Metal mounting clips.

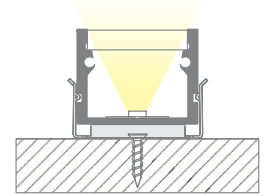
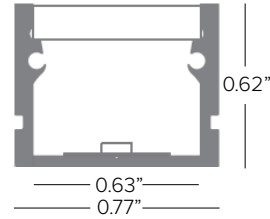

NOTE: 118 inch lengths must be shipped via freight only. For efficient shipping via UPS/Fedex, lengths can be cut to 59 inch upon request.

SURFACE PROFILES CONT.

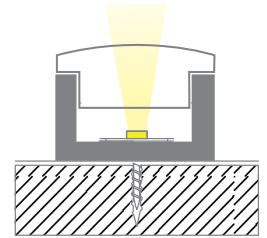
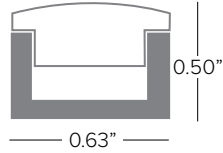
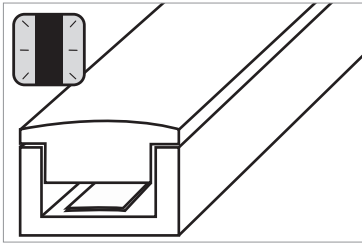

DL-ALUM-C-6

Surface mounted two-piece continuous illumination profile. 1/2"H x 5/8"W aluminum U-channel with 6" OC screw holes. Snap in full diffusion lens for shadowless light distribution. Available in 6ft lengths.

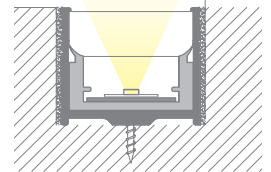
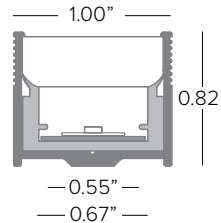

PRINTC-G

Rigid high impact resistant PMMA profile complete with a white plastic diffuser lensed channel for recessed walk over installation. Complete with track for easy strip insertion. Available in 3.28ft (1M) lengths.

KTPRINTC-G

2+2 PC end caps

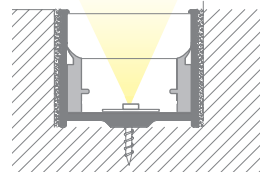
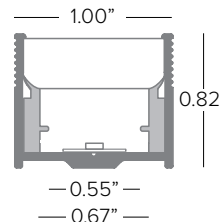

PRINTC-GUS

Rigid high impact resistant PMMA profile complete with two part white plastic diffuser lens and aluminum channel for surface or recessed mounting. Available in 3.28ft (1M) lengths.

KTPRINTC-G

2+2 PC end caps

SURFACE PROFILES CONT.

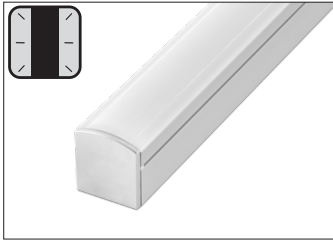

PRAP-U

Surface mount aluminum profile. Anodized aluminum rigid profile complete with opal translucent diffuser cover. Available in 79in (2M) lengths.

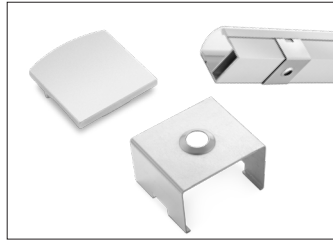

KTPRAP-UEC

5 + 5 silver color end caps

KTPRU-CL

5 sets of clips

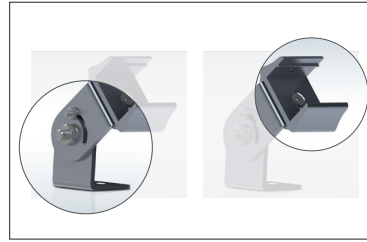

OR-DEV

Set of steel supports required with use of KTORDEV-U.

KTORDEV-U

Set of aluminum mounting heads required with use of OR-DEV.

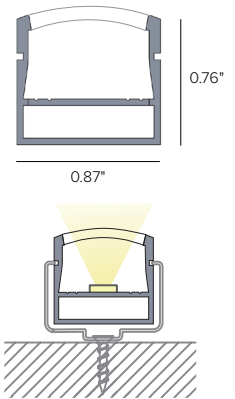

PRIN-U

Flush mount aluminum profile. Anodized aluminum rigid profile complete with opal translucent diffuser cover. Available in 79in (2M) lengths.

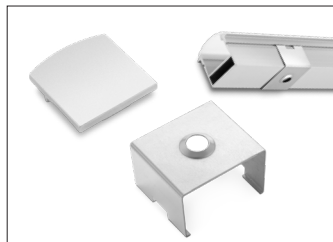

KTPRIN-UEC

5 + 5 silver color end caps

KTPRU-CL

5 sets of clips

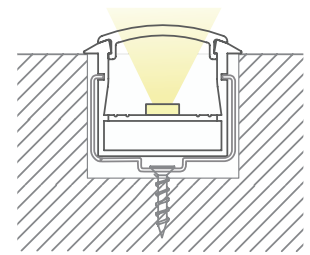
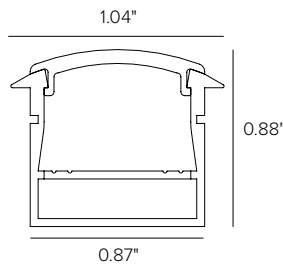

PRAN-U

45° aluminum profile. Anodized aluminum rigid profile complete with opal translucent diffuser cover. Available in 79in (2M) lengths.



KTPRAN-UEC

5 + 5 silver color end caps

KTPRAN-UCL

5 sets of clips

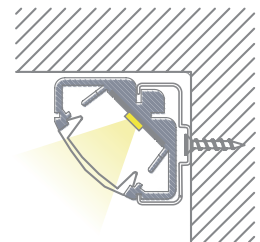
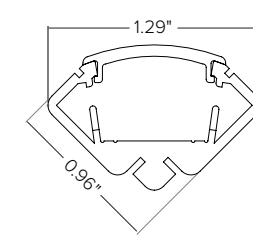

ADJUSTABLE PROFILES



P02C-S-PF-300

180° adjustable aluminum profile with wall washer function for surface with suitable clips. Available in 118in (3M) lengths.



P02C-A-EC

3+3 metal end caps.

P02C-A-OB

3 Metal adjustable brackets.

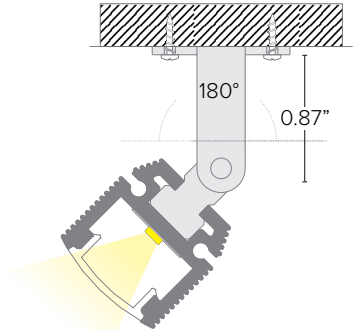
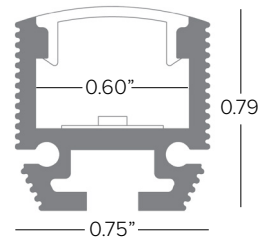

NOTE: 118 inch lengths must be shipped via freight only. For efficient shipping via UPS/Fedex, lengths can be cut to 59 inch upon request.



P03C-S-PF-300

180° adjustable aluminum profile with wall washer function for surface with suitable clips. Lens shape creates narrower spread. Available in 118in (3M) lengths.

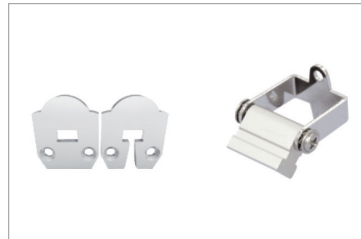

P03C-A-EC

3+3 metal end caps.

P03C-A-OB

6 Metal adjustable brackets.

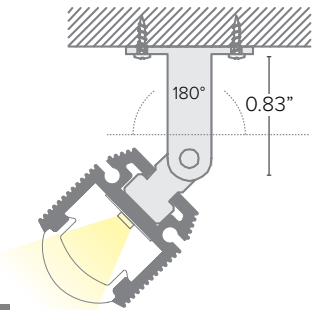
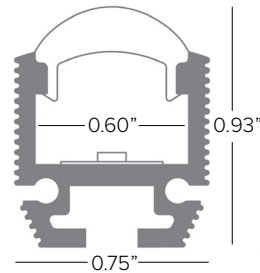

NOTE: 118 inch lengths must be shipped via freight only. For efficient shipping via UPS/Fedex, lengths can be cut to 59 inch upon request.



P04C-S-PF-300

Fixed profile at 30° with a wall washer function for surface installation. Available in 118in (3M) lengths.



P04C-A-EC

3+3 metal end caps.

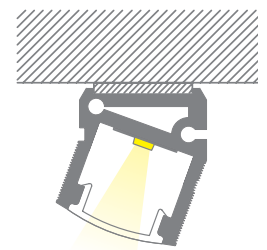
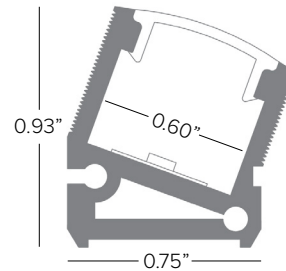

NOTE: 118 inch lengths must be shipped via freight only. For efficient shipping via UPS/Fedex, lengths can be cut to 59 inch upon request.

Power Supply (REQUIRED)	Type	Wattage	Input/Output Voltage	Dimmable	IP Rating	Output	Dimensions
DEDDX1001242CDMX	ELECTRONIC ADDRESSABLE DMX DRIVER	100W	120-277V / 24V	DMX CONTROL 2 CHANNEL	NEMA3R ENCLOSURE	UL CLASS 2	12" x 12" x 4" ¹
DEDDX2002242CDMX	ELECTRONIC ADDRESSABLE DMX DRIVER	2X100W	120-277V / 24V	DMX CONTROL 2 CHANNEL	NEMA3R ENCLOSURE	UL CLASS 2	12" x 12" x 4" ¹

¹ Dimensions include enclosure with mounting bracket.

* Constant voltage drivers 50/60HZ, voltage regulated with short circuit protection. Operating temperature -40 C- 80° C

* Installation of power supply must be compliant to Class 2 installation standards. Refer to NEC and local building code requirements.

MAXIMUM INTERCONNECTED TAPE LENGTH PER DRIVER

Fixture Wattage	Driver Wattage	
	100W	2X100
4.3W/ft	18FT	(2) 18FT

Controller (Optional)	Type	Application	Voltage	Listing	Dimensions	# of DMX Channels	Number of Zones	Number of Scenes
SWITCH23	CCT Touch DMX512 Wall Control Panel with Sensitive Glass Touch Panel, White Finish	Indoor Only	12-24V DC	UL	4.73"H x 2.95"W x 1.15"D	2	1	6



SWITCH23



a brand of TARGETTI

DURATAPE™ TUNABLE CCT

IP65 OUTDOOR

PHOTOMETRY

DURATAPE CCT			POLAR GRAPH
Fixture Power	4.3W	4.3W	
Fixture Output	305Lm	329Lm	
Kelvin Temp	1800-3500K	2700-6500K	
Beam Spread	120°	120°	
IMax	316cd/klm	316cd/klm	
Efficacy	71 Lm/W	77 Lm/W	