

# INTELLISTRAND RGB

## Dynamic Color Changing Low Voltage Strand

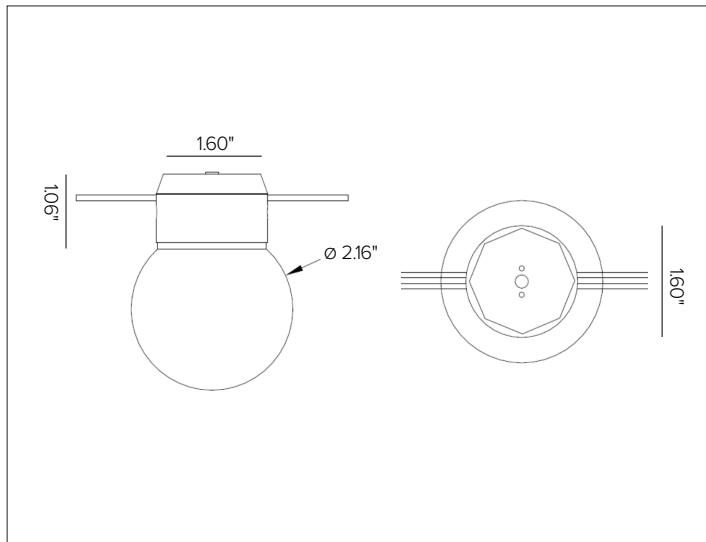
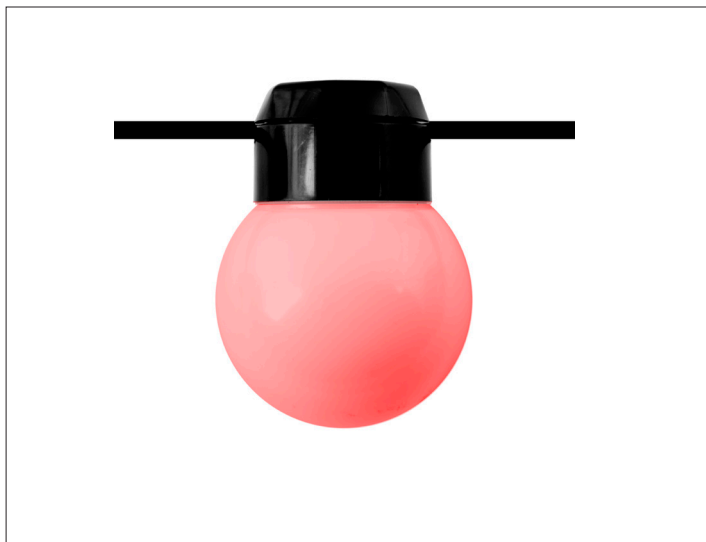

### CONCEPT

Low voltage dynamic color changing cable light strand, perfect for festoon mounting, taught or swayed.

### MECHANICAL CHARACTERISTICS

<b>Power Connection</b>	16-3 cable with factory attached sockets.	
<b>Spacing</b>	12" O.C. / 24" O.C.	
<b>Installation</b>	For festoon mounting, fixture can be mounted to aircraft cable or secured with cable ties. Recommended for use with cable wrap option to encase both aircraft cable and Intellistrand cable for a clean, one wire look. For surface mounting, the flat back of the fixtures can be secured with surface mount clip.	
<b>Protection</b>	IP65	
<b>Weight</b>	0.25Lbs per socket	
<b>Max. Length</b>	12" O.C.: 75' max per run	24" O.C.: 150' max per run

### CERTIFICATIONS

cETLus Class 2 Wet Listed 4007019  
 Energy efficient for California installations  
 Tested in accordance RoHS3 EU 215/863

### WARRANTY

5 year limited warranty

### ELECTRICAL CHARACTERISTICS

<b>Power Supply</b>	Remote Class 2 120V-277V AC power supply required, see available options. Operates with DMX-Over-Power, Non-Dimming Power Supply and DMX 512 control wired together in 3 conductor configuration. 0% dim range. 24 bit individually addressable spheres for dramatic full color lighting effects. Refer to Targetti <a href="#">Onsite Services</a> for additional programming and installation support.
<b>Wattage</b>	11W max./Sphere
<b>Voltage</b>	24V DC

### SOURCE

	6 high efficiency tri-chip LED diodes.	
<b>TM30</b>	<b>CCT (Nominal)</b>	
	RGB	

### OPTIC

	Polycarbonate spherical opal lens.	
<b>Beam</b>	 <b>Opal 200°</b>	
<b>Delivered Lumens</b>	<b>2300k</b>	45Lm/Sphere
<b>Efficacy</b>	40.9lm/W	
<b>Lifetime</b>	L90 40,000hrs at max TA +25°C	

# INTELLISTRAND RGB

## SPECIFICATION INFORMATION

IN	CL										
1	2	3	4	5	6	7	8	9	10	11	12
Ex: INCL1FC1224 / INTEL06 / INTEL08 / DEL10013524						REQUIRED		OPTIONAL	REQUIRED	OPTIONAL	

1 - PRODUCT CODE	2 - TYPE	3 - WATTAGE	4 - COLOR TEMP	5 - SPACING	6 - VOLTAGE
IN – Intellistrand	CL – Cable Light	1 – 1W	FC – RGB	12 – 12" O.C. 24 – 24" O.C.	24 – 24V DC
7 - CONNECTION	8 - END CAP	9 - MOUNTING	10 - POWER SUPPLY	11 - CONTROL	12 - DECORATIVE
<a href="#">3ft 4 Pole Connector</a> See section for details <a href="#">8ft 4 Pole Connector</a> See section for details <a href="#">16ft 4 Pole Connector</a> See section for details <a href="#">20ft 4 Pole Connector</a> See section for details <a href="#">T-Split Cable Connector</a> See section for details <a href="#">DMX T-Split Cable Connector</a> See section for details <a href="#">10ft 2 Pole Connector</a> See section for details <a href="#">20ft 2 Pole Connector</a> See section for details	<a href="#">End Cap</a> See section for details	<a href="#">Aircraft Cable</a> See section for details <a href="#">Spiral Cable Wrap</a> See section for details <a href="#">Black PVC Mounting</a> See section for details	<a href="#">Power Supply</a> See section for details	<a href="#">DMX Controller</a> See section for details	<a href="#">Decorative Shade</a> See section for details

## INSTALLATION EXAMPLES

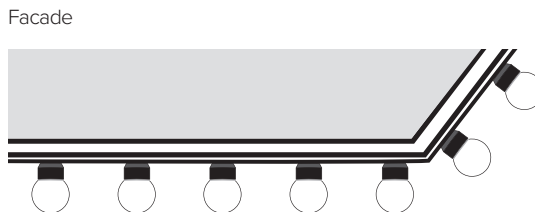
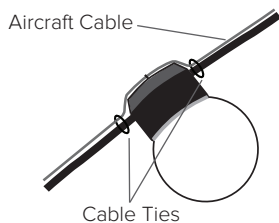

Straight (shown with DLDSLWRAP) Recommended



Swayed

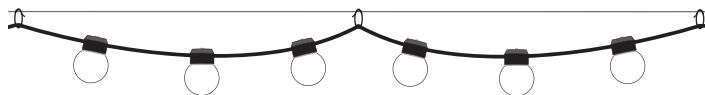

# INTELLISTRAND RGB

## 7 - CONNECTION CABLE (REQUIRED)

Length of connection cables must be included in max length calculation

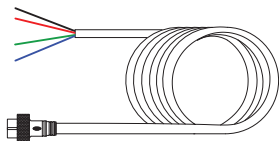

DMX / Power Lead cable 3ft length with 4-pole female connector.

Finish Black

Part No. **INTEL06**

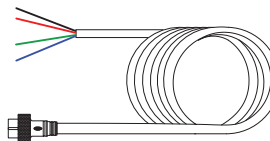

DMX / Power Lead cable 20ft length with 4-pole female connector.

Finish Black

Part No. **INTEL33**

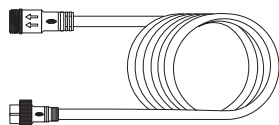

DMX / Power Jumper cable 8ft length with 1ea 4-pole female connector and 4-pole male connector.

Finish Black

Part No. **INTEL66**

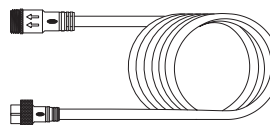

DMX / Power Jumper cable 16ft length with 1ea 4-pole female connector and 4-pole male connector.

Finish Black

Part No. **INTEL31**

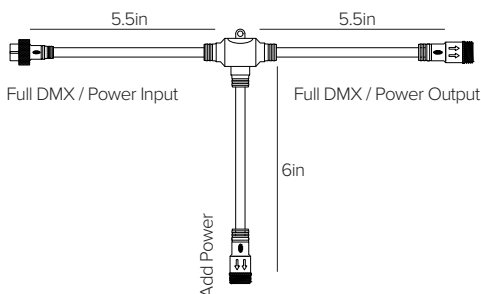

Power Add T-split cable with 1ea 4-pole female connector, 4-pole male connector and 2-pole male connector.

Finish Black

Part No. **INTEL07**

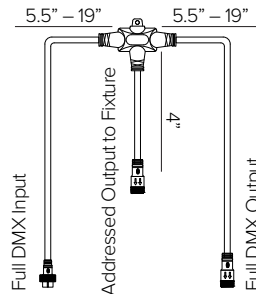

Addressable DMX T-split cable. 2ea 4-pole female connectors and 1ea 4-pole male connector. **Must be factory programmed to specific address requirements.**

Finish Black

Part No. **INTEL32**

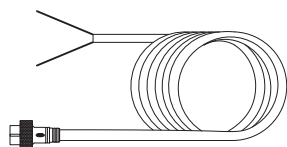

Low voltage Lead cable 10ft length with 2-pole female connector.

Finish Black

Part No. **INTEL09**

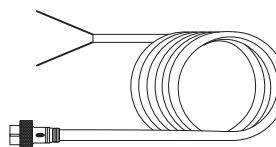

Low voltage Lead cable 20ft length with 2-pole female connector.

Finish Black

Part No. **INTEL19**

## 8 - END CAP (REQUIRED)

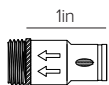

End cap. 4-Pole Male DMX termination.

Finish Black

Part No. **INTEL08**

# INTELLISTRAND RGB

## 9 - MOUNTING (OPTIONAL)

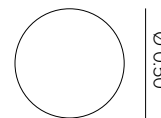
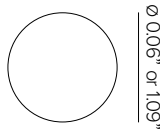

Stainless steel aircraft cable, available per foot. **Recommended 1/16" aircraft cable for wall to wall installation configurations, 3/32" aircraft cable for pole to pole installation configurations. For straight/taught installations, add an additional 5ft to each run for fixing lead and end connections.**

Load	1/16" Dia., up to 70Lbs load	3/32" Dia., up to 150Lbs load
Weight	1/16" SS Cable 0.0085 lbs/ft	3/32" SS Cable 0.02 lbs/ft
Part No.	<b>DLDC1AC1/16SS</b>	<b>DLDC1AC3/32SS</b>

Spiral cable wrap, available per foot.

**To be used with aircraft cable to encase aircraft cable and DURALED LIGHT CABLE for a clean one wire look. 1.5ft of wrap needed to span evenly per 1ft of cable.**

Finish	● Black
Part No.	<b>DLDSLWRAP</b>

## 10 - POWER SUPPLY (REQUIRED)

STANDALONE							
Part No.	Wattage	Dim Range	Rating	In / Out Voltage	Certification	Dimensions (Standalone)	Description
<b>DEL10013524</b>	96W	Non-Dimmable	IP67	120-277V / 24V	UR Class 2	8.66" x 2.68" x 1.53"	Mean Well HLG electronic power supply. <b>UL listed enclosure provided by others.</b>

## 12 – CONTROL (OPTIONAL)

Part No.	Channels	Scenes	Zones	Rating	Voltage	Certification	Dimensions	Description
<b>TGDMXSLES9</b>		256	20	1	Indoor	5.5V DC	ETL, UL	5.3"W x 5.5"H x 1.9D Nicolaudie Slesa smart DMX 1/2 universe programmable controller with easy to use software interface.
<b>TGDMXSLES11</b>		1024	5	99	Indoor	5VDC 120V AC Plug in power supply included	ETL	6.3" x 3.6" x 1.8" Nicolaudie Slesa smart DMX interface, 2 DMX 512 universes, intuitive backlit keyboard programmable controller with easy to use software interface.
<b>TGDMXSTICKDE3B</b>		1024	10	500	Indoor	6-7V DC 120V AC Plug in power supply included	ETL	5.8" x 4.2" x 0.5" Nicolaudie intelligent control keypad with glass touch sensitive graphic display, stand-alone DMX 512, 2 universe programmable controller with easy to use software interface. Black finish.
<b>TGDMXSTICKDE3W</b>		1024	10	500	Indoor	6-7V DC 120V AC Plug in power supply included	ETL	5.8" x 4.2" x 0.5" Nicolaudie intelligent control keypad with glass touch sensitive graphic display, stand-alone DMX 512, 2 universe programmable controller with easy to use software interface. White finish.

## 13 - DECORATIVE (OPTIONAL)



Black PVD Shown

Decorative shade accessory.  
Weight: 1.6 oz.

Finish ● Stainless Steel ● Bronze PVD\* ● Black PVD\*

\*Physical Vapor Deposition

Part No.	<b>INCLSHADESS</b>	<b>INCLSHADESSBZ</b>	<b>INCLSHADESSBL</b>
----------	--------------------	----------------------	----------------------

# INTELLISTRAND RGB

## SYSTEM LAYOUT EXAMPLE DIAGRAM

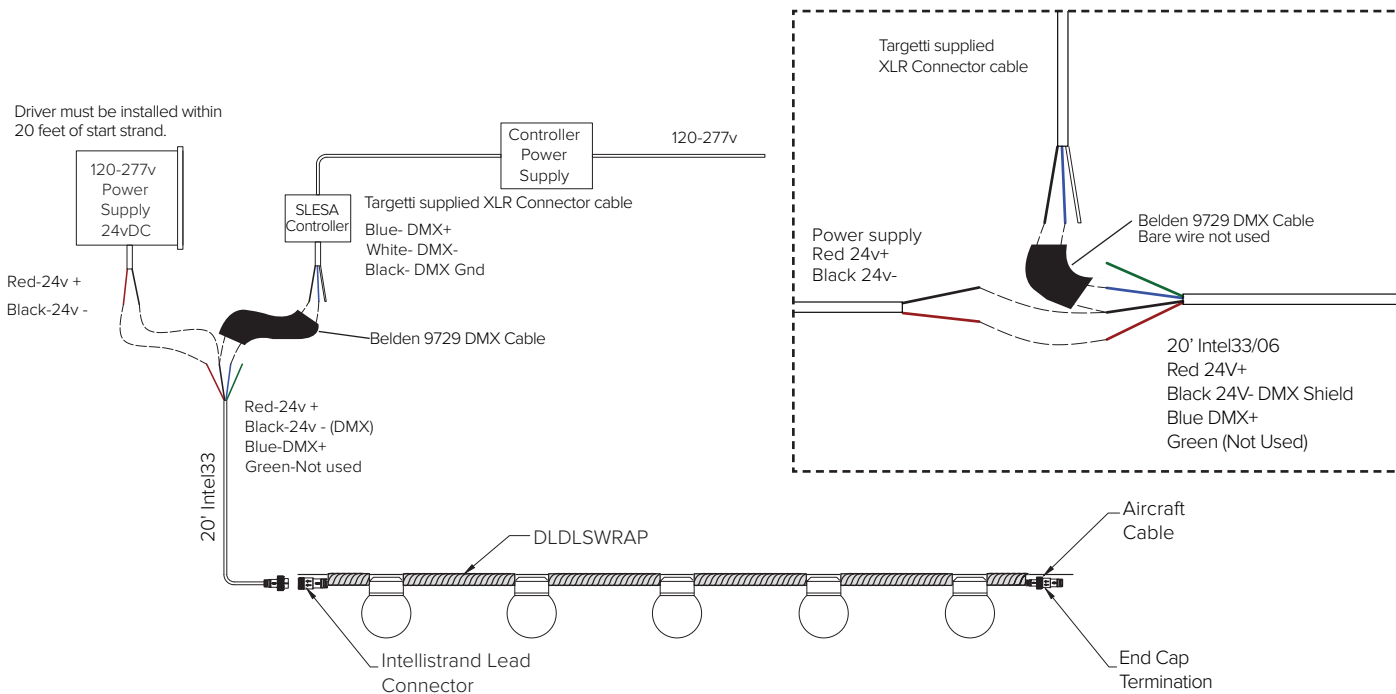

3rd Part DMX 512 configuration Belden 9729 recommended

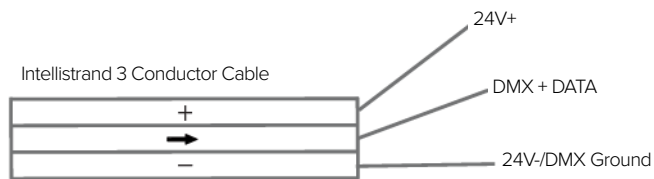

Intelistrand product is directional and must be installed with factory connectors to ensure proper operation.

## POSSIBLE CONFIGURATIONS

Targetti USA can supply project specific wiring diagrams upon request.

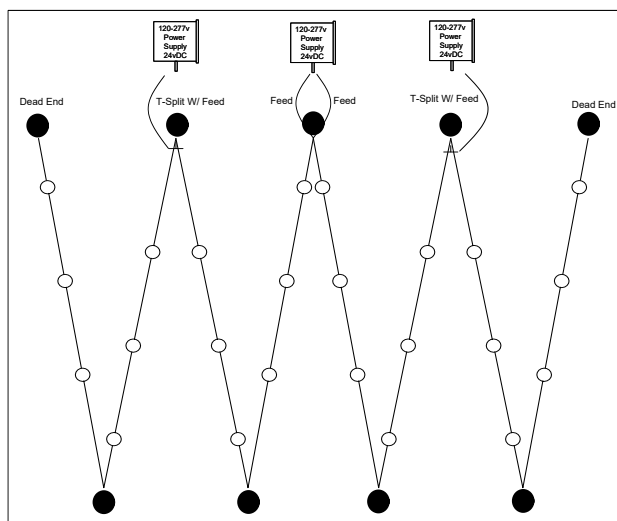
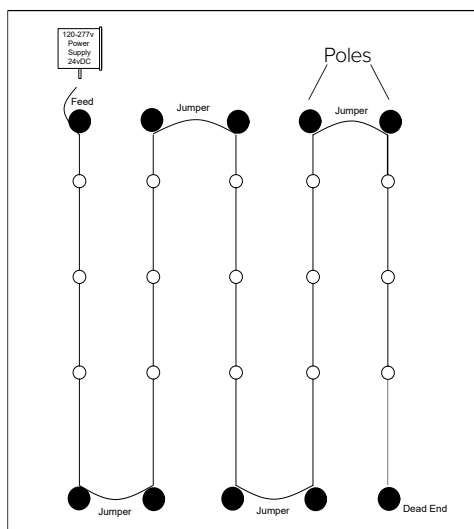

# INTELLISTRAND RGB

## PHOTOMETRY

IES FILES WATTAGE AND EFFICIENCY CALCULATIONS BASED WITH SUPPLIED DRIVER

