

KEPLERO GIMBAL

Professional Inground LED Fixture

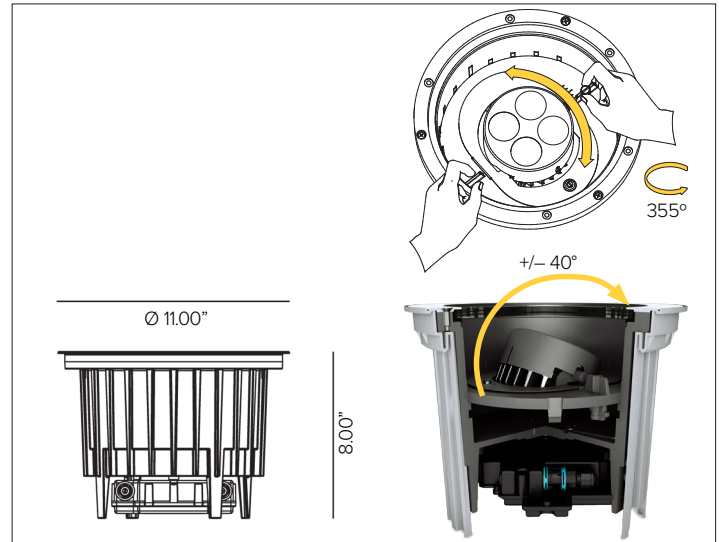

KEPLERO® GIMBAL with brushed natural trim and clear lens.



CONCEPT

High performance inground LED gimbal incorporating maximum precision and control for specific aimed illumination of objects.

MECHANICAL CHARACTERISTICS

Housing	8"H x 11"Dia. Housing.
Materials	Anodized marine grade cataphoresis ^A die-cast aluminum heat sink body with PVC installation sleeve. AISI316L stainless steel trim ring with beveled edge with extra clear glass lens.
Finish	● Brushed Natural ● Bronze PVD* ● Black PVD* *Physical Vapor Deposition.
Power Connection	Provided with 4ft SJ00W 16-6 cable and DSM&T anti-wicking quick disconnect to direct burial brass ingrade j-box (required, sold separately).
Functionality	Adjustable +/-40° on the vertical axis and rotated 355° on the horizontal axis with friction locking mechanism.
Mounting	Flush, semi-flush or raised tube mountings. Installation sleeve for flush or semi-flush mountings includes optional stainless steel 'L' brackets for additional mounting support. Fixture equipped with fastening holes and stainless steel screws for attachment into installation sleeve assembly.
Weight	11.0lbs
Protection	IP68 ^B / IP69K
Impact	IK10
Load	Resistant to static loads up to 4,496lbs in flush mounted cement and pavement installations.

CERTIFICATIONS

cULus Wet Location Listed.
 Tested in accordance with LM-79-08.
 Compliant for California installations.
 IEC 62471
 RoHS3 EU 215/863

SUSTAINABILITY

Luminaire designed for disposal/recycling at end-of-life. Replaceable LED light source and control gear by a Targetti technician.

ELECTRICAL CHARACTERISTICS

Power Supply	Integrated 4/1 smart driver (Non-dimmable / 0-10V / Reverse Phase / Forward Phase).
Wattage	15W nominal
Voltage	Universal Voltage 120-277V AC 50/60Hz

SOURCE

High efficiency LED emitter.

TM30	CCT (Nominal)	CRI	R _f	R _g	SDCM
	3000K	80	85	98.8	2
	4000K	80	85	99.1	2

Ra90 available upon request

OPTIC

4 LED gimbal optical system equipped with PMMA lenses.

Beam	NSP 10°	FL 30°	EL 43° x 30°
Delivered Lumens	3000K 1116Lm	956Lm	887Lm
	4000K 1116Lm	956Lm	887Lm

Efficacy	79Lm/W max. Refer to photometric graphs for specific values.
Lifetime	L96/B10 30,000hrs at max TA +25°C L94/B10 50,000hrs at max TA +25°C
Photobiological Classification	Low risk safety RG1

WARRANTY

5 year limited warranty.
^A Fixture body complete with marine grade cataphoresis suitable for use in marine grade environments. Stainless steel trim will need to be maintained and cleaned regularly to avoid mineral deposits. Not to be in direct contact with salt or corrosive agents for extended periods of time.
^B Temporary immersion up to 24 hours at a max depth of 2 meters. Installation of fixture requires proper drainage to prevent any standing water. Should not be used for permanent submersion.

KEPLERO GIMBAL

SPECIFICATION INFORMATION



1 - PRODUCT CODE	2 - DRIVER	3 - TYPE	4 - OPTICS	5 - WATTAGE	6 - KELVIN
KPL — KEPLERO	41 — 4/1 Smart Driver (Non-Dimming / 0-10V / Reverse Phase / Forward Phase)	GMB — Gimbal	NS — NSP 10° FL — FL 30° EL — Elliptical 43° x 30°	L1 — 15W	30 — 3000K 40 — 4000K
7 - TRIM	8 - INSTALLATION	9 - INSTALLATION ACCESSORIES	10 - OPTICAL ACCESSORIES		
Round Trim Ring See section for details	Flush Mount Sleeve See section for details Raised Tube See section for details Junction Box See section for details	Torx Key See section for details Fixture Removal Tool See section for details Glass Removal Tool See section for details	Holder Ring See section for details Anti Glare Honeycomb Louver See section for details Half Moon Anti Glare Shutter See section for details Chromatic Filter See section for details		

KEPLERO GIMBAL

7 - TRIM (REQUIRED)

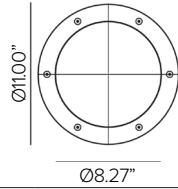

Round stainless steel (AISI316L) decorative ring. 10mm thick extra clear protective glass. Silicone gasket. Tamper proof (AISI316L) Torx screws.

Finish Brushed Natural Bronze PVD Black PVD

Part No. **1DU2325** **1DU2325B** **1DU2325K**

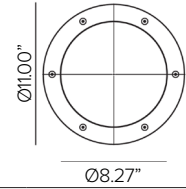
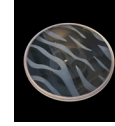

Round stainless steel (AISI316L) decorative ring with anti-slip glass. 10mm thick extra clear protective glass. Silicone gasket. Tamper proof (AISI316L) Torx screws.

Finish Brushed Natural Bronze PVD Black PVD

Part No. **1DU2325A** **1DU2325BA** **1DU2325KA**

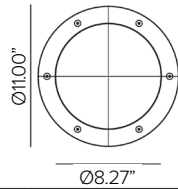

Round stainless steel (AISI316L) decorative ring with half frosted glass. 10mm thick extra clear protective glass. Silicone gasket. Tamper proof (AISI316L) Torx screws.

Finish Brushed Natural Bronze PVD Black PVD

Part No. **1DU2325E** **1DU2325BE** **1DU2325KE**

KEPLERO GIMBAL

8 - INSTALLATION (REQUIRED)

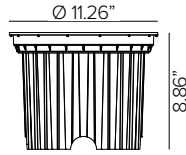

Installation sleeve for concrete pour applications. Grey Nylon 9" sleeve with 4.77" aluminum extension sleeve. Complete with dedicated cover cap for installations in concrete. Round ring for flush or semi-flush installations.

Part No. **1DU2394**

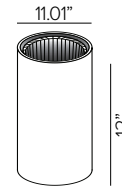

At grade or raised installation sleeve for turf or ground cover applications. 12"H stainless steel, includes factory pre-installed inner PVC installation sleeve. **Not suitable for use with 1DU2394.** (Field cuttable. Used for fixture elevations at grade to 3" above grade). **Required for use with 1DU2530 by NEC.**

Finish ● Deep Black

Part No. **1DU434312**

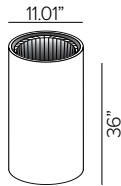

Raised installation sleeve for ground cover (succulents and low level planting) applications. 18"H stainless steel, includes factory pre-installed inner PVC sleeve. **Not suitable with 1DU2394.** (Field cuttable. Used for fixture elevation 7" above grade). **Required for use with 1DU2530 by NEC.**

Finish ● Deep Black

Part No. **1DU434318**

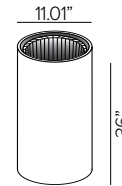

Raised installation sleeve for landscape applications. 36"H stainless steel, includes factory pre-installed inner PVC sleeve. **Not suitable with 1DU2394.** (Field cuttable. Used for fixture elevation 7" above grade). **Required for use with 1DU2530 by NEC.**

Finish ● Deep Black

Part No. **1DU4343**

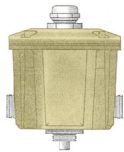

Direct burial brass in-grade j-box. Features stainless steel cover screws and strain relief for power cord, (2) 3/4" NPT bottom holes and (2) 3/4" NPT side holes. Includes (4) 3/4" to 1/2" adapters and (2) 1/2" NPT plugs. **(REQUIRED by NEC).**

Part No. **1DU2530**

9 - INSTALLATION ACCESSORIES (OPTIONAL)



Fixture metal maintenance removal handle. Helpful one per 10 fixtures.

Part No. **1E2496**



Anti-vandal torx head. Helpful one per 5 fixtures.

Part No. **1E2495**



Glass suction removal tool. Helpful one per 20 fixtures.

Part No. **1E0388**

KEPLERO GIMBAL

10 - OPTICAL ACCESSORIES (OPTIONAL)

MAXIMUM OF TWO OPTICAL FILTERS OR LOUVER ACCESSORY PER FIXTURE

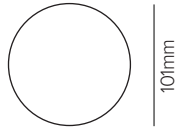

'Blade of Light' linear spread lens. Parallel ribbed glass.

Part No. **1T1696**

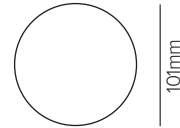

Anti-glare honeycomb louver with lacquered metal structure.

Finish ● Deep Black

Part No. **1T1699**

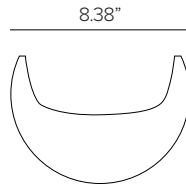

Integral half moon anti glare shutter. **Can be used as one per fixture with a filter or louver, not considered as part of the maximum optical accessories.**

Finish ● Deep Black

Part No. **1E2402**

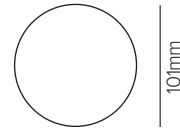

Tone filter. Glass filter to vary the color temperature of light.

Finish Cold Tone Gold Tone Peach Tone

Part No. **1T1781 1T1790 1T1766**

KEPLERO GIMBAL

INSTALLATION DIAGRAM

CONCRETE POUR APPLICATION



Flush Mount Sleeve Assembly
1DU2394 Sleeve

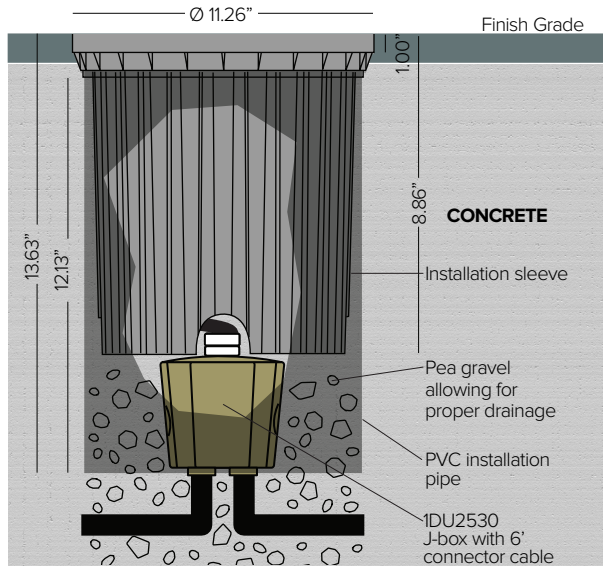

Semi-Flush Mount Sleeve Assembly
1DU2394 Sleeve

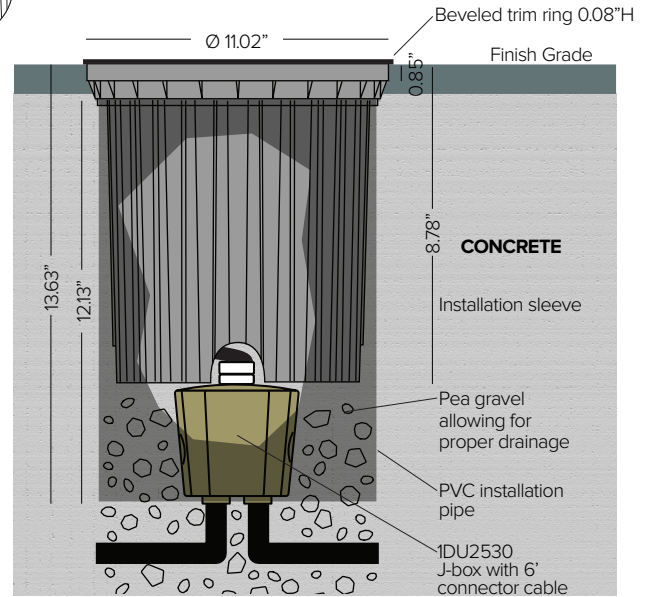

KEPLERO GIMBAL

INSTALLATION DIAGRAM

LANDSCAPE APPLICATION

RAISED TUBE INSTALLATION ASSEMBLY

Recommended for Landscape Installation
1DU4343

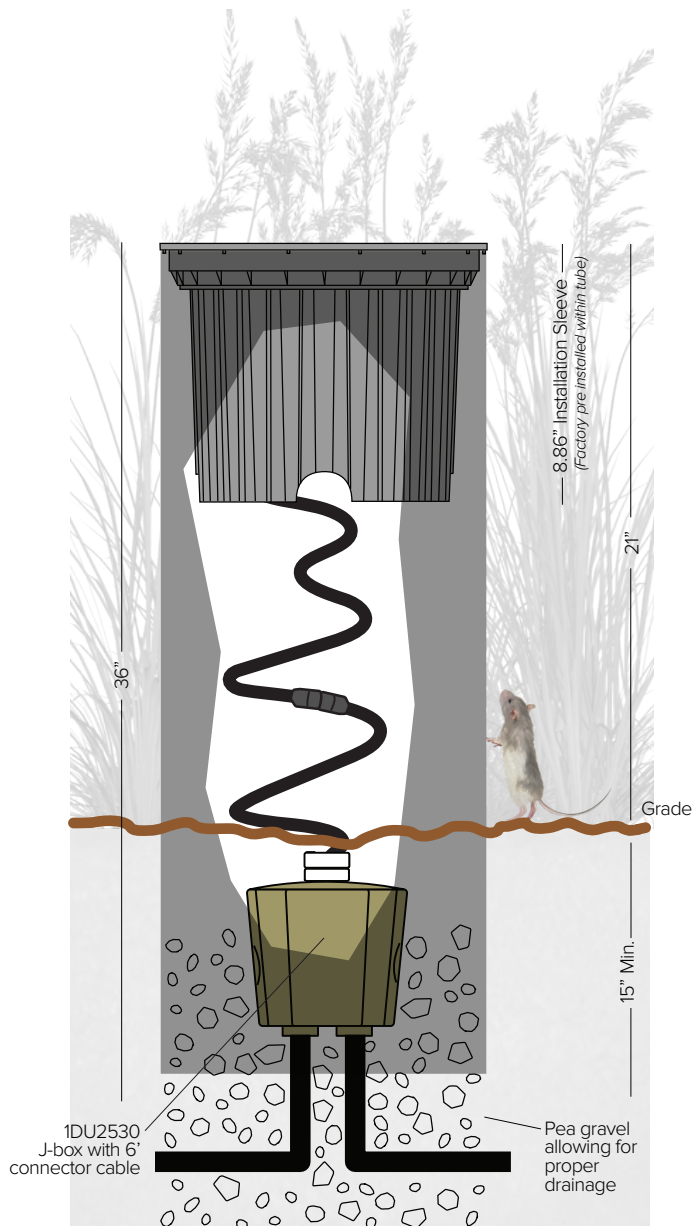

RAISED TUBE INSTALLATION ASSEMBLY

Recommended for Ground Level Installation
1DU434318

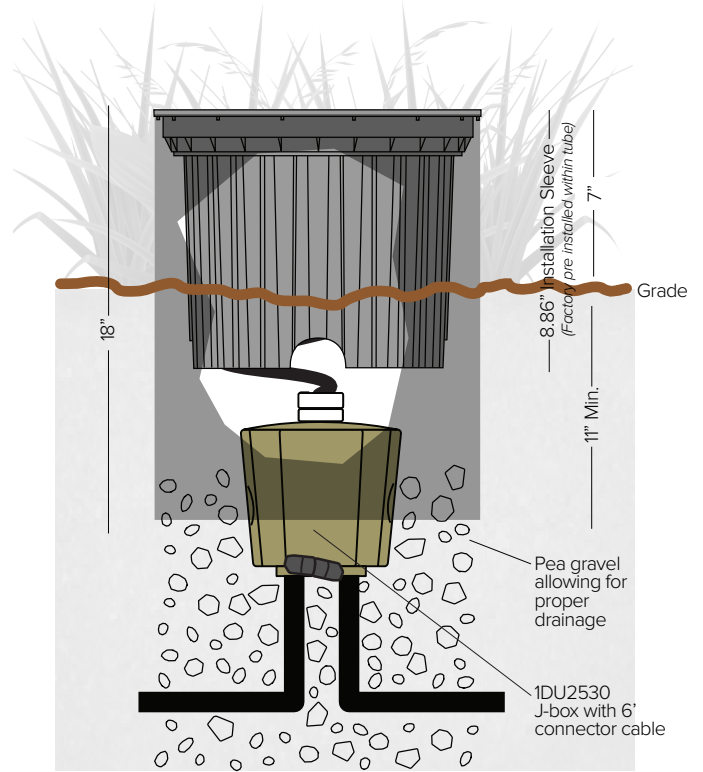

RAISED TUBE INSTALLATION ASSEMBLY

Recommended for Turf Installation
1DU434312

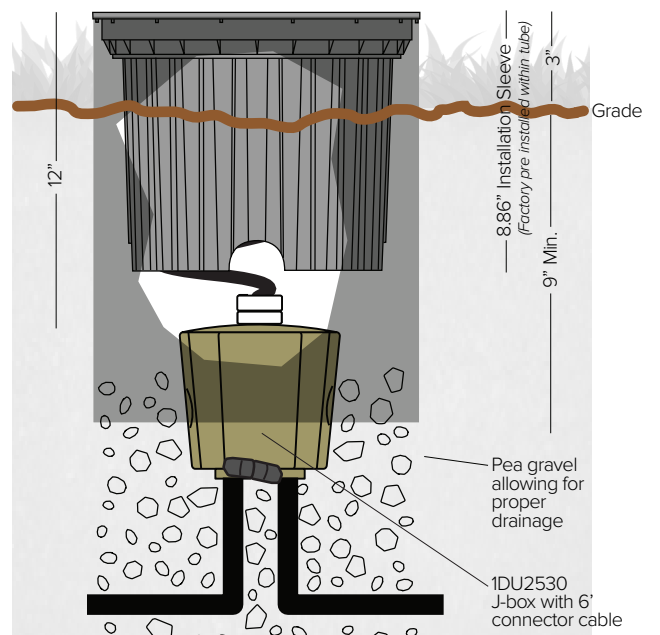

KEPLERO GIMBAL

INSTALLATION DIAGRAM - 1DU2530 J-Box

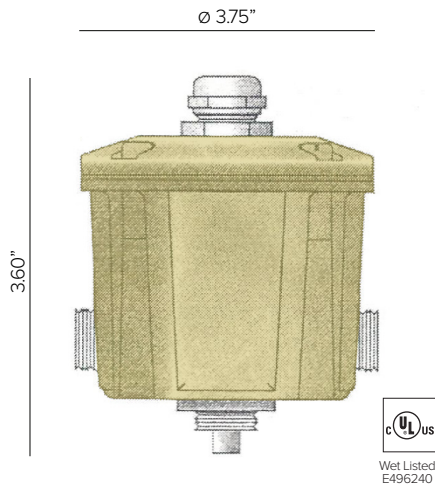

Brass junction box is supplied with the following components:

- (4) 3/4" side/bottom NPT holes
- (4) 1/2" reduction NPT adapters
- (2) 1/2" cap plugs

NOTE: Box fill size = 15.94 IN³

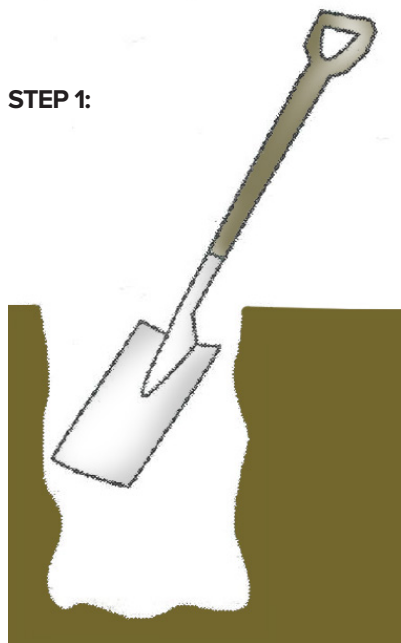

Dig a hole large enough to accommodate the junction box.

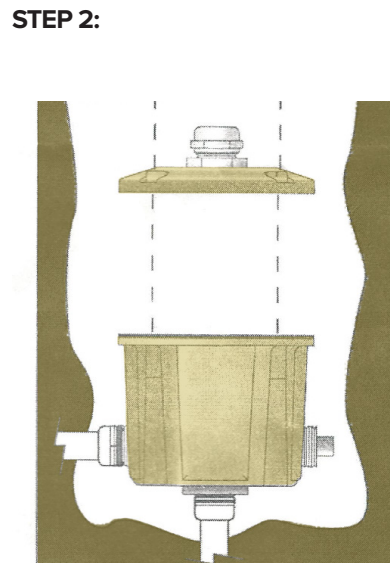

Connect brass junction box to conduit system. Seal conduit entries inside junction box with a good grade RTV sealant per sealant manufacturer's instructions.
Note: Drainage must be in place below junction box.

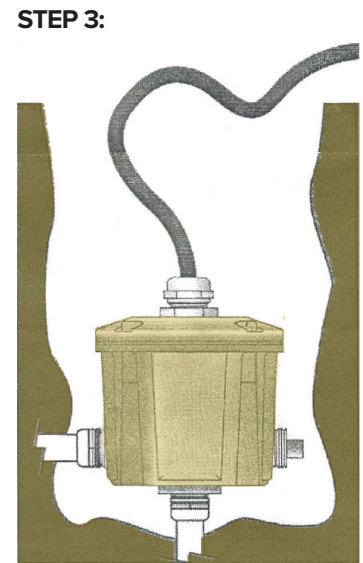

Seal threads. Tighten locking screw on bottom of cover. Connect all wires observing polarity (i.e. green-to-ground, white-to-common, and black-to-voltage). Provided with 1/2" strain relief.

KEPLERO GIMBAL

PHOTOMETRY

NARROW SPOT

3000K		H(m)	D(m)	E _{max} (lx)		
Ra80			10°			
Fixture Power	14W	1	0.17	25425		
Source Flux	1410lm	2	0.35	6356		
Fixture Flux	1116lm	3	0.52	2825		
Efficacy	79lm/W	4	0.70	1589		
TS1575	I _{max} =18032cd/klm	I _{max}	25425cd	5	0.87	1017

4000K		H(m)	D(m)	E _{max} (lx)		
Ra80			10°			
Fixture Power	14W	1	0.17	25425		
Source Flux	1410lm	2	0.35	6356		
Fixture Flux	1116lm	3	0.52	2825		
Efficacy	79lm/W	4	0.70	1589		
TS1575	I _{max} =18032cd/klm	I _{max}	25425cd	5	0.87	1017

FLOOD

3000K		H(m)	D(m)	E _{max} (lx)		
Ra80			30°			
Fixture Power	14W	1	0.53	3512		
Source Flux	1410lm	2	1.06	878		
Fixture Flux	956lm	3	1.60	390		
Efficacy	68lm/W	4	2.13	220		
TS1576	I _{max} =2491cd/klm	I _{max}	3512cd	5	2.66	140

4000K		H(m)	D(m)	E _{max} (lx)		
Ra80			30°			
Fixture Power	14W	1	0.53	3512		
Source Flux	1410lm	2	1.06	878		
Fixture Flux	956lm	3	1.60	390		
Efficacy	68lm/W	4	2.13	220		
TS1576	I _{max} =2491cd/klm	I _{max}	3512cd	5	2.66	140

ELLIPTICAL

3000K		H(m)	D1(m)	D2(m)	E _{max} (lx)		
Ra80			43°	30°			
Fixture Power	14W	1	0.78	0.53	1888		
Source Flux	1410lm	2	1.56	1.07	472		
Fixture Flux	887lm	3	2.34	1.60	210		
Efficacy	63lm/W	4	3.13	2.13	118		
TS1577	I _{max} =1339cd/klm	I _{max}	1888cd	5	3.91	2.67	76

4000K		H(m)	D1(m)	D2(m)	E _{max} (lx)		
Ra80			43°	30°			
Fixture Power	14W	1	0.78	0.53	1888		
Source Flux	1410lm	2	1.56	1.07	472		
Fixture Flux	887lm	3	2.34	1.60	210		
Efficacy	63lm/W	4	3.13	2.13	118		
TS1577	I _{max} =1339cd/klm	I _{max}	1888cd	5	3.91	2.67	76