

KEPLERO MINI GIMBAL

Professional Inground LED Fixture

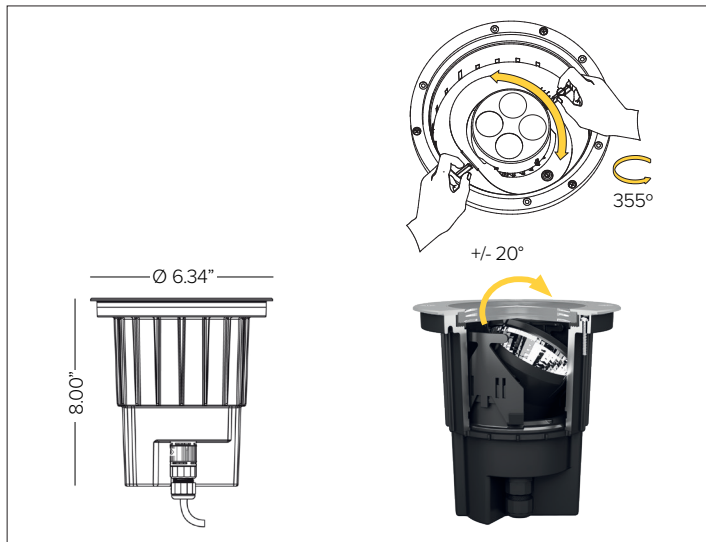

KEPLERO® Mini Gimbal with brushed natural trim and clear lens



CONCEPT

Compact high performance inground four LED gimbal incorporating maximum precision and control for specific aimed illumination of objects.

MECHANICAL CHARACTERISTICS

Housing	8"H x 6.34"Dia. Housing.
Materials	Anodized marine grade cataphoresis ^A die-cast aluminum heat sink body with PVC installation sleeve. AISI316L stainless steel trim ring with beveled edge with extra clear glass lens.
Finish	● Brushed Natural ● Bronze PVD* ● Black PVD* *Physical Vapor Deposition.
Power Connection	Provided with 4ft SJ00W 16-6 cable and DSMT anti-wicking quick disconnect to direct burial brass ingrade jbox (required, sold separately).
Functionality	Adjustable +/-20° on the vertical axis and rotated 355° on the horizontal axis with friction locking mechanism.
Mounting	Flush, semi-flush or raised tube mountings. Installation sleeve for flush or semi-flush mountings includes optional stainless steel 'L' brackets for additional mounting support. Fixture equipped with fastening holes and stainless steel screws for attachment into installation sleeve assembly.
Weight	2.43lbs
Protection	IP68 ^B / IP69K
Impact	IK10
Load	Resistant to static loads up to 4,496lbs in flush mounted cement and pavement installations.

CERTIFICATIONS

cULus Wet Location Listed.
 Tested in accordance with LM-79-08.
 Compliant for California installations.
 IEC 62471
 RoHS3 EU 215/863

SUSTAINABILITY

Luminaire designed for disposal/recycling at end-of-life. Replaceable LED light source and control gear by a Targetti technician.

ELECTRICAL CHARACTERISTICS

Power Supply	Integral 4/1 smart driver (Non-Dimmable / 0-10V / Reverse Phase / Forward Phase).
Wattage	11W
Voltage	Universal Voltage 120-277V AC 50/60Hz

SOURCE

High Efficiency LED Emitter

TM30	CCT (Nominal)	CRI	Rf	Rg	SDCM
	3000K	80	85	93.8	2
	4000K	80	85.2	94.7	2

Ra90 available upon request

OPTIC

Four LED gimbal optical system.

Beam	SP 15°	FL 29°
Delivered Lumens	3000K 788Lm 4000K 835Lm	746Lm 790Lm
Efficacy	79Lm/W max. Refer to photometric graphs for specific values.	
Lifetime	L95/B10 30,000hrs at max TA +25°C L93/B10 50,000hrs at max TA +25°C	
Photobiological Classification	Low risk safety RG1	

WARRANTY

5 year limited warranty.
^A Fixture body complete with marine grade cataphoresis suitable for use in marine grade environments. Stainless steel trim will need to be maintained and cleaned regularly to avoid mineral deposits. Not to be in direct contact with salt or corrosive agents for extended periods of time.
^B Temporary immersion up to 24 hours at a max depth of 2 meters. Installation of fixture requires proper drainage to prevent any standing water. Should not be used for permanent submersion.

KEPLERO MINI GIMBAL

SPECIFICATION INFORMATION

KPLM									
1	2	3	4	5	6	7	8	9	10
Ex: KPLM41GMB SPL130 / 1E2525 / 1DU2521 / 1DU2530						REQUIRED		OPTIONAL	

1 - PRODUCT CODE	2 - DRIVER	3 - TYPE	4 - OPTICS	5 - WATTAGE	6 - KELVIN
KPLM — KEPLERO MINI	41 — 4/1 Smart Dimming (Non-Dimming / 0-10V / Reverse Phase / Forward Phase)	GMB — Gimbal	SP — SP 15° FL — FL 29°	L1 — 11W	30 — 3000K 40 — 4000K

7 - TRIM	8 - INSTALLATION	9 - INSTALLATION ACCESSORIES	10 - OPTICAL ACCESSORIES
Round Trim Ring See section for details Square Trim Ring See section for details	Flush Mount Sleeve See section for details Raised Tube See section for details Junction Box See section for details	Torx Key See section for details Fixture Removal Tool See section for details Glass Removal Tool See section for details	Blade of Light Linear Spread Lens See section for details Anti Glare Honeycomb Louver See section for details Half Moon Anti Glare Shutter See section for details Chromatic Filter See section for details

For applicable quick ship items, see model configurations listed below. Lead time for quick ship fixtures is 1-2 weeks from processed PO date. Consult factory for quantities of over 20pcs to confirm lead time.



QSKPLM41GMBFLL130 + 1E2525 + 1DU2521 + 1DU2530

KEPLERO MINI GIMBAL

6 - TRIM (REQUIRED)

ROUND TRIM RING



Round stainless steel (AISI316L) decorative ring. 10mm thick extra clear protective glass. Silicone gasket. Tamper proof (AISI316L) Torx screws.

Finish ● Brushed Natural ● Bronze PVD ● Black PVD

Part No. **1E2525** **1DU2525B** **1DU2525K**



Round stainless steel (AISI316L) decorative ring with anti-slip glass. 10mm thick extra clear protective glass. Silicone gasket. Tamper proof (AISI316L) Torx screws.

Finish ● Brushed Natural ● Bronze PVD ● Black PVD

Part No. **1DU2525A** **1DU2525BA** **1DU2525KA**



Round stainless steel (AISI316L) decorative ring with half frosted glass. 10mm thick extra clear protective glass. Silicone gasket. Tamper proof (AISI316L) Torx screws.

Finish ● Brushed Natural ● Bronze PVD ● Black PVD

Part No. **1DU2525E** **1DU2525BE** **1DU2525KE**

SQUARE TRIM RING



Square stainless steel (AISI316L) decorative ring. 10mm thick extra clear protective glass. Silicone gasket. Tamper proof (AISI316L) Torx screws.

Finish ● Brushed Natural

Part No. **1E2526**



Square stainless steel (AISI316L) decorative ring. 10mm thick extra clear protective glass. Silicone gasket. Tamper proof (AISI316L) Torx screws.

Finish ● Brushed Natural

Part No. **1DU2526A**

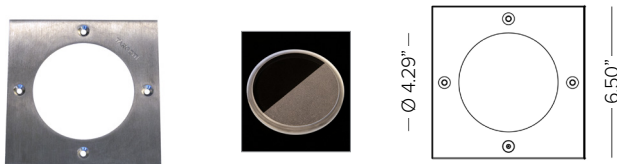

Square stainless steel (AISI316L) decorative ring. 10mm thick extra clear protective glass. Silicone gasket. Tamper proof (AISI316L) Torx screws.

Finish ● Brushed Natural

Part No. **1DU2526E**

KEPLERO MINI GIMBAL

7 - INSTALLATION (REQUIRED)

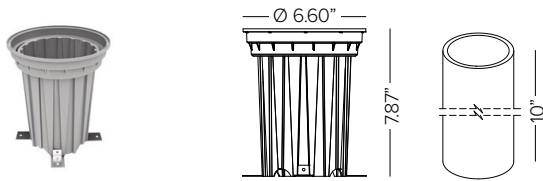

Installation sleeve for concrete pour applications. Grey Nylon casing with PVC installation outer pipe. For flush or semi-flush installations. **Required for use with 1DU2530 by NEC.**

Part No. **1DU2521**

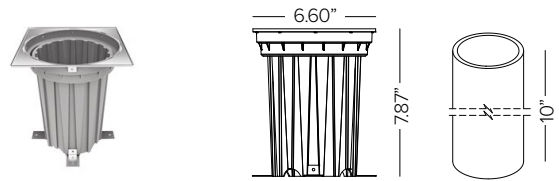

Installation sleeve for concrete pour applications. Grey Nylon casing and stainless steel profile with PVC installation outer pipe. Square ring for flush installation only. **For use with square trim options only. Required for use with 1DU2530 by NEC.**

Part No. **1DU2522**

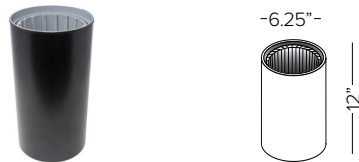

At grade or raised installation sleeve for turf or ground cover applications. 12"H stainless steel, includes factory pre-installed inner PVC installation sleeve. **To be used with round trim options only. Not suitable for use with 1DU2521 or 1DU2522.** (Field cuttable. Used for fixture elevations at grade to 3" above grade). **Required for use with 1DU2530 by NEC.**

Finish ● Deep Black

Part No. **1DU434412**



Raised installation sleeve for ground cover (succulents and low level planting) applications. 18"H stainless steel, includes factory pre-installed inner PVC sleeve. **To be used with round trim options. Not suitable with 1DU2521 or 1DU2522.** (Field cuttable. Used for fixture elevation 7" above grade). **Required for use with 1DU2530 by NEC.**

Finish ● Deep Black

Part No. **1DU434418**

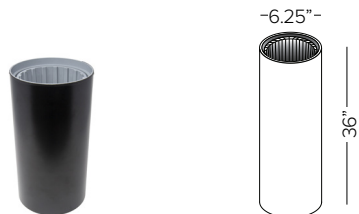

Raised installation sleeve for landscape applications. 36"H stainless steel, includes factory pre-installed inner PVC sleeve. **To be used with round trim options. Not suitable with 1DU2521 or 1DU2522.** (Field cuttable. Used for fixture elevation 21" above grade). **Required for use with 1DU2530 by NEC.**

Finish ● Deep Black

Part No. **1DU4344**

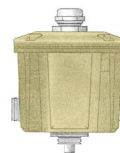

Direct burial brass ingrade j-box. Features stainless steel cover screws and strain relief for power cord, (2) 3/4" NPT bottom holes and (2) 3/4" NPT side holes. Includes (4) 3/4" to 1/2" adapters and (2) 1/2" NPT plugs. **(REQUIRED by NEC).**

Part No. **1DU2530**

8 - INSTALLATION (OPTIONAL)



Fixture metal maintenance removal handle. Helpful one per 10 fixtures.

Part No. **1E2524**



Anti-vandal torx head. Helpful one per 5 fixtures.

Part No. **1E2495**



Glass suction removal tool. Helpful one per 20 fixtures.

Part No. **1E0388**

KEPLERO MINI GIMBAL

9 - OPTICAL ACCESSORIES (OPTIONAL)

MAXIMUM OF ONE OPTICAL FILTER OR LOUVER ACCESSORY PER FIXTURE

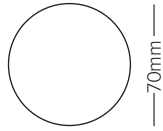

'Blade of Light' linear spread lens. Parallel ribbed glass.

Part No. **1T1708**

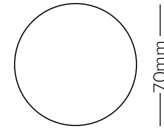

Anti-glare honeycomb louver with lacquered metal structure.

Finish ● Deep Black

Part No. **1T1711**

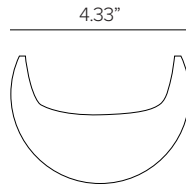

Integral half moon anti glare shutter. **Can be used as one per fixture with a filter or louver, not considered as part of the maximum optical accessories.**

Finish ● Deep Black

Part No. **1E2523**

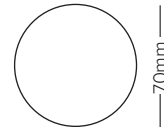

Tone filter. Glass filter to vary the color temperature of light.

Finish Peach Tone Cold Tone Gold Tone

Part No. **1T1759 1T1777 1T1786**

KEPLERO MINI GIMBAL

INSTALLATION DIAGRAM

CONCRETE POUR APPLICATION



Flush Mount Sleeve Assembly
1DU2521 and 1DU2522 Sleeves

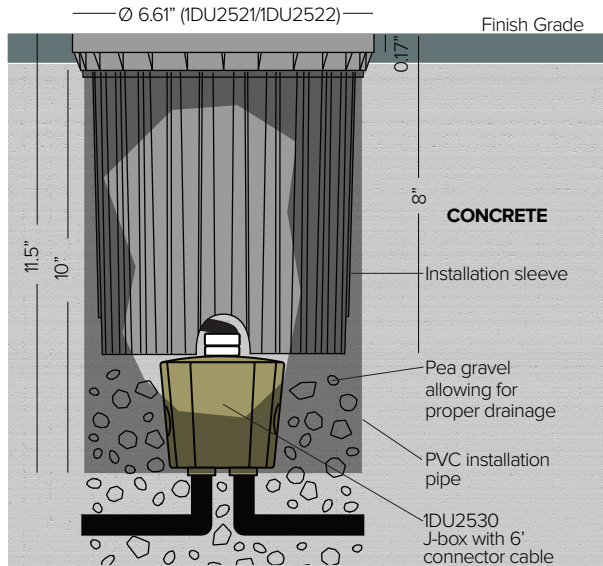

Semi-Flush Mount Sleeve Assembly
1DU2521 Sleeve Only

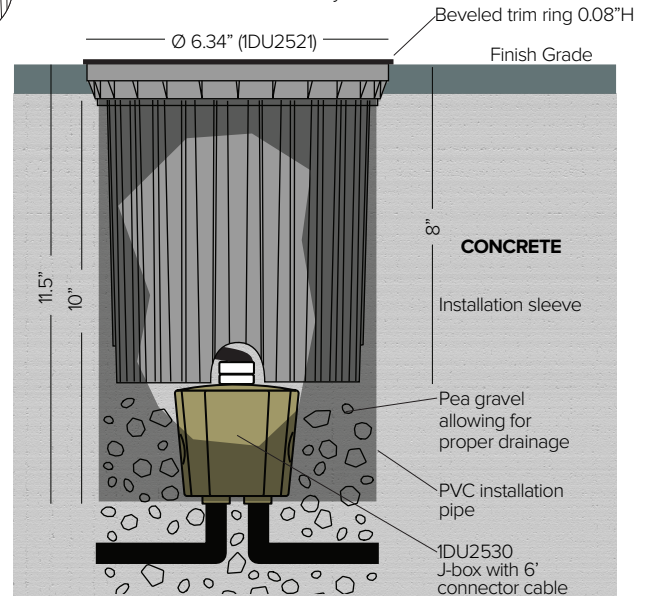

KEPLERO MINI GIMBAL

INSTALLATION DIAGRAM

LANDSCAPE APPLICATION

RAISED TUBE INSTALLATION ASSEMBLY

Recommended for Landscape Installation
1DU4344 with Round Trim ONLY

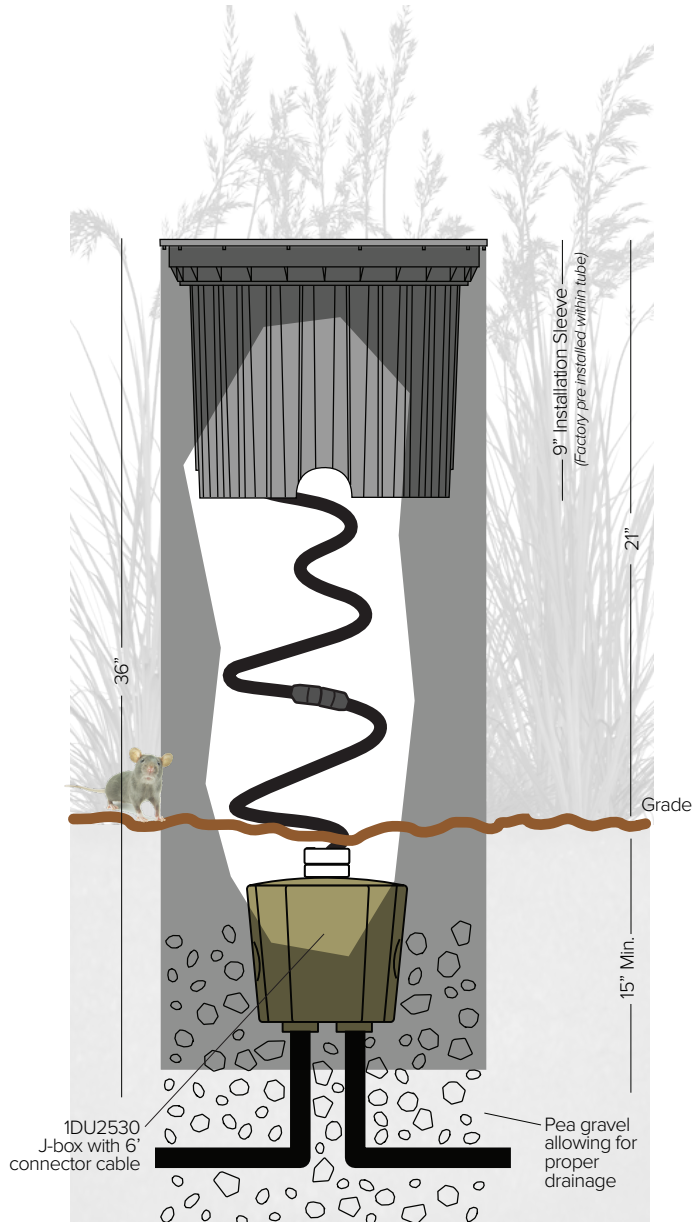

RAISED TUBE INSTALLATION ASSEMBLY

Recommended for Ground Level Installation
1DU434418 with Round Trim ONLY

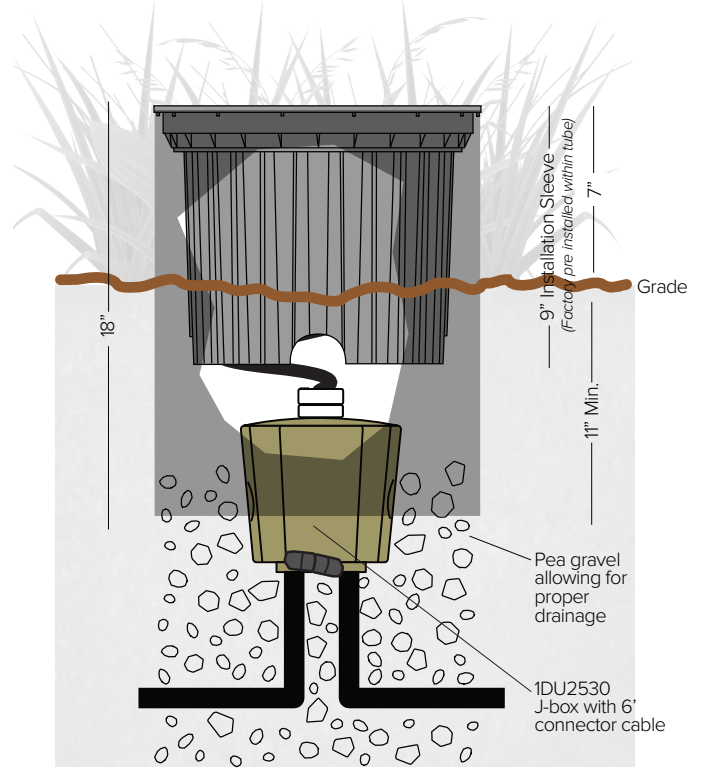

RAISED TUBE INSTALLATION ASSEMBLY

Recommended for Turf Installation
1DU434412 with Round Trim ONLY

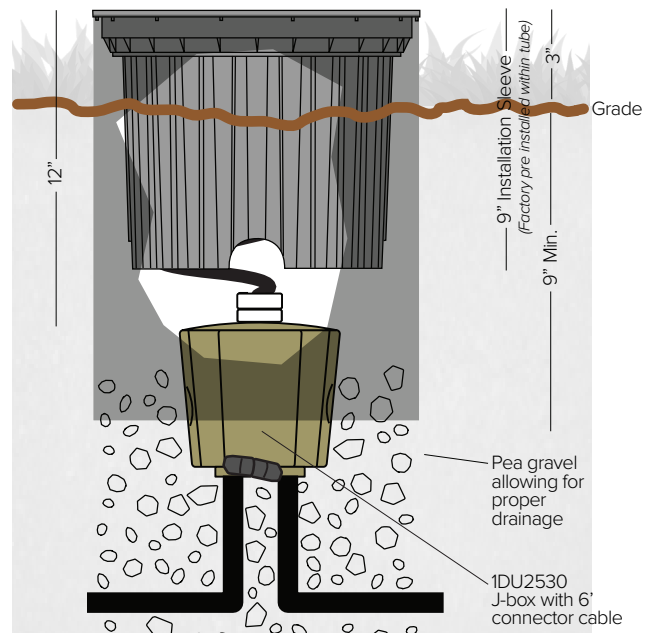

KEPLERO MINI GIMBAL

INSTALLATION DIAGRAM - 1DU2530 J-Box

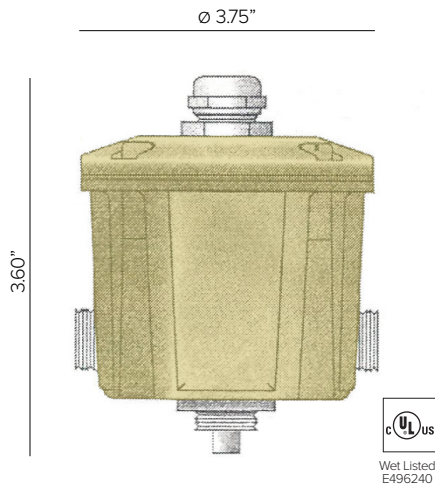

Brass junction box is supplied with the following components:

- (4) $\frac{3}{4}"$ side/bottom NPT holes
- (4) $\frac{1}{2}"$ reduction NPT adapters
- (2) $\frac{1}{2}"$ cap plugs

NOTE: Box fill size = 15.94 IN³

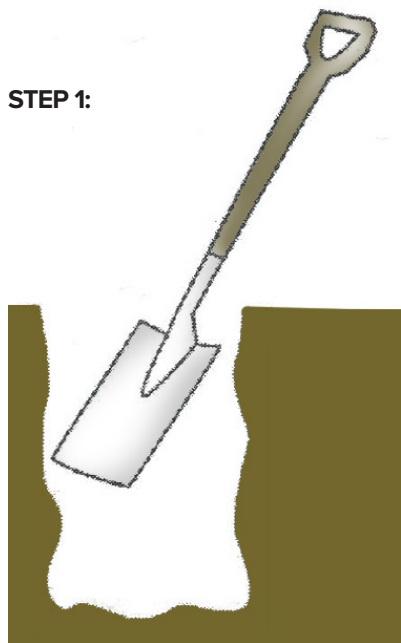

STEP 1:

Dig a hole large enough to accommodate the junction box.

STEP 2:

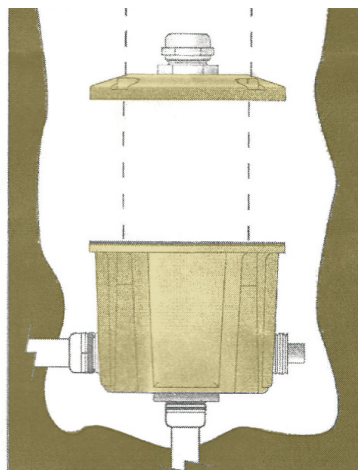

Connect brass junction box to conduit system. Seal conduit entries inside junction box with a good grade RTV sealant per sealant manufacturer's instructions.
Note: Drainage must be in place below junction box.

STEP 3:

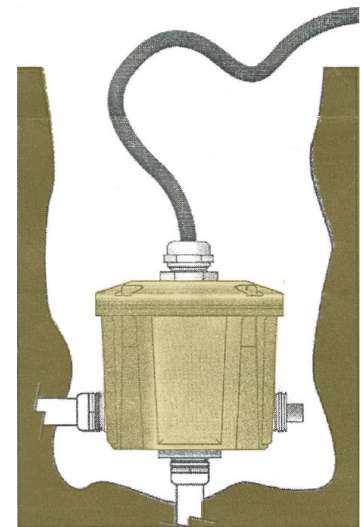

Seal threads. Tighten locking screw on bottom of cover. Connect all wires observing polarity (i.e. green-to-ground, white-to-common, and black-to-voltage). Provided with $\frac{1}{2}"$ strain relief.

KEPLERO MINI GIMBAL

PHOTOMETRY

SPOT

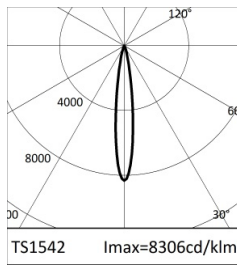

3000K		H(m)	D(m)	Emax(lx)		
Ra80			15°			
Fixture Power	11W	1	0.26	8322		
Source Flux	1002lm	2	0.51	2081		
Fixture Flux	788lm	3	0.77	925		
Efficacy	74lm/W	4	1.02	520		
TS1542	I _{max} =8306cd/klm	I _{max}	8322cd	5	1.28	333

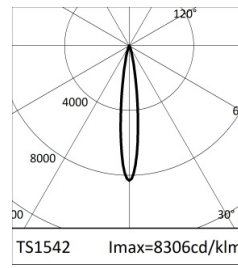

4000K		H(m)	D(m)	Emax(lx)		
Ra80			15°			
Fixture Power	11W	1	0.26	8821		
Source Flux	1062lm	2	0.51	2205		
Fixture Flux	835lm	3	0.77	980		
Efficacy	79lm/W	4	1.02	551		
TS1542	I _{max} =8306cd/klm	I _{max}	8821cd	5	1.28	353

FLOOD



3000K		H(m)	D(m)	Emax(lx)		
Ra80			29°			
Fixture Power	11W	1	0.53	2729		
Source Flux	1002lm	2	1.05	682		
Fixture Flux	746lm	3	1.58	303		
Efficacy	70lm/W	4	2.10	171		
TS1543	I _{max} =2724cd/klm	I _{max}	2729cd	5	2.63	109



4000K		H(m)	D(m)	Emax(lx)		
Ra80			29°			
Fixture Power	11W	1	0.53	2893		
Source Flux	1062lm	2	1.05	723		
Fixture Flux	790lm	3	1.58	321		
Efficacy	75lm/W	4	2.10	181		
TS1543	I _{max} =2724cd/klm	I _{max}	2893cd	5	2.63	116