

KEPLERO WALL WASHER RGBW

Professional Inground LED Fixture

Concept: Professional addressable DMX 512 controlled RGBW LED inground recessed wall washer.

Housing: 8" tall x 11" diameter die-cast aluminum housing. Cast aluminum, powder coated integrated power supply box with integrated IP68 connector ports.

Materials: Anodized and powder coated black die-cast aluminum heat sink with PVC installation sleeve and stainless steel (AISI316L) trim ring with extra clear glass (anti-slip available). ^ABody completed with marine grade cathaphoresis suitable for use in marine grade environments. Stainless steel trim will need to be maintained and cleaned regularly to avoid mineral deposits.

Trim: Stainless steel (AISI316L) trim available in ultra flat round decorative ring, with beveled edge in brushed natural, bronze or black finishes. Features tamper-proof Torx screws.

Optic: Wall Wash 106° x 66° optical unit includes acrylic lens, a high reflectance asymmetrical anodized aluminum reflector and integral holographic filter for even illumination of vertical surfaces as well as excellent light diffusion at ground level. This unique reflector system allows the Keplero Wall Wash fixtures to be installed at an unparalleled 1:5 ratio for completely uniform illumination on the vertical surface. Range of motion: +/- 15° optic rotation on the vertical axis and rotates 360° on the horizontal plane with integrated locking system.

Mounting: Flush and semi-flush installation sleeves with stainless steel extension sleeve or optional raised installation tube for landscape. Fixture includes screw down holes and stainless steel screws for attachment to installation sleeve. Includes optional stainless steel L brackets for mounting support. Installation sleeve required for flush or semi-flush mounting (sold separately).

Driver: Universal voltage integrated IP68 electronic driver.

Installation: Fixture flush mount installation includes 9" tall x 11" diameter sleeve, extension sleeve for wire slack and accessibility. Optional Raised landscape tubes in 3 sizes for Turf, Ground Cover and Shrub installations. 4ft 6-pole multi conductor cable with resin filled IP68 connector to prevent water wicking issues even with cut cable and 15ft DMX Direct Burial Lead cable and fixture to fixture Jumpers with IP68 connectors with gold plated pin and socket contacts for improved long term data transmission available in varied lengths to be specified and ordered separately.

Wattage: Max 58W with full color operation.

Color Temperature: Red 630nm, Green 530nm, Blue 470nm, 4000K.

Lumen Maintenance (L70): 50,000hrs

Calculation for LED fixtures are based on measurements that comply with IES LM-80.

Voltage: Universal Voltage 120-277V AC 50/60Hz

IK Rating: IK10

IP Rating: IP67*, IP68 Tested**

Load Rating: Resistant to static loads up to 4,496lbs in flush mounted cement and pavement installations.

Certifications: cULus Wet Listed E477426

Tested in accordance with LM-79-08

Energy efficient for California installations.

Warranty: 5 year limited warranty

* Up to 1 METER DEPTH of water for up to a maximum of 30 MINUTES

** Not suitable for submersible installations

^ANot to be in direct contact with salt for extended periods of time or used with corrosive agents.



KEPLERO® Wall Washer RGBW with Clear Lens

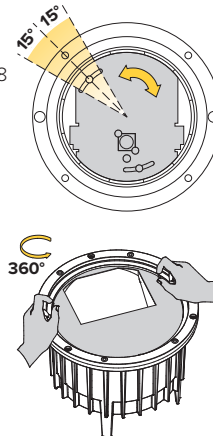

Delivered Lumens:



- Blue = 113Lm
- Green = 593Lm
- Red = 359Lm
- White = 357Lm
- RGB = 949Lm
- RGBW = 1091Lm

PRODUCT CODE	TYPE	WATTAGE	COLOR TEMP	TRIM & INSTALLATION
KPL — KEPLERO	WW — Wall Wash	L1 — 58W	RGBWE2 — Red, Green, Blue & 4000°K White	Required (See Pg 2)

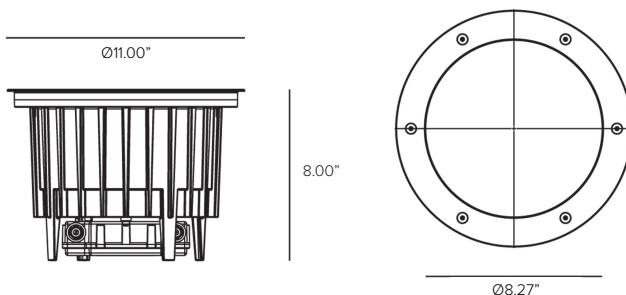
Views



KEPLERO WALL WASHER RGBW

TRIM RING (REQUIRED) - CHOOSE 1			
Round Trim Ring (Available in Brushed Natural, Bronze, and Black PVD finishes)			
			Description
1DU2325	1DU2325B	1DU2325K	Round stainless steel (AISI316L) decorative ring. 10mm thick extra clear protective glass. Silicone gasket. Tamper proof (AISI316L) Torx screws.
1DU2325A	1DU2325BA	1DU2325KA	Round stainless steel (AISI316L) decorative ring with anti-slip glass. 10mm thick extra clear protective glass. Silicone gasket. Tamper proof (AISI316L) Torx screws.



Trim Ring

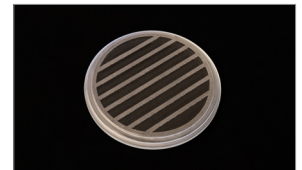

Anti-Slip Glass

INSTALLATION SLEEVE (REQUIRED) - CHOOSE 1	
1DU2394	Installation sleeve for concrete pour applications. Grey Nylon 9" casing with 4.5" aluminum extension sleeve. Complete with dedicated cover cap for installations in concrete. Round ring for flush or semi-flush installations.
1DU4343	Raised installation sleeve for landscape applications. 36"H stainless steel painted deep black finish, includes 9" inner sleeve. (Field cuttable. Used for fixture elevation 21" above ground). Not suitable with 1DU2394.
1DU434318	Raised installation sleeve for ground cover (succulents and low level planting) applications. 18"H stainless steel painted deep black finish, includes 9" inner sleeve. (Field cuttable. Used for fixture elevation 3" above ground). Not suitable with 1DU2394.
1DU434312	At grade or raised installation sleeve for turf or ground cover applications. Raised installation sleeve for turf applications. 12"H stainless steel painted deep black finish, includes 9" inner sleeve. (Field cuttable. Used for fixture elevations at grade to 3" above grade). Not suitable with 1DU2394.



1DU2394

INSTALLATION ACCESSORIES:	
1DU2530	Direct burial brass ingrade j-box. Features stainless steel cover screws and strain relief for power cord, (2) 3/4" NPT bottom holes and (2) 3/4" NPT side holes. Includes (4) 3/4" to 1/2" adaptors and (2) 1/2" NPT plugs. (REQUIRED)
1E2495	Anti-vandal torx head. Suggested one per 5 fixture.
1E2496	Fixture metal maintenance removal handle. Helpful one per 10 fixtures.
1E0388	Glass suction removal tool. Helpful one per 20 fixtures.

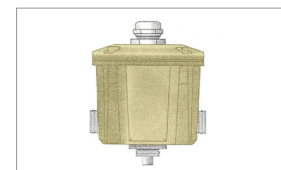

1DU2530



1E2495



1E2496



1E0388

TARGETTI

KEPLERO WALL WASHER RGBW

RGBW Wiring Diagram

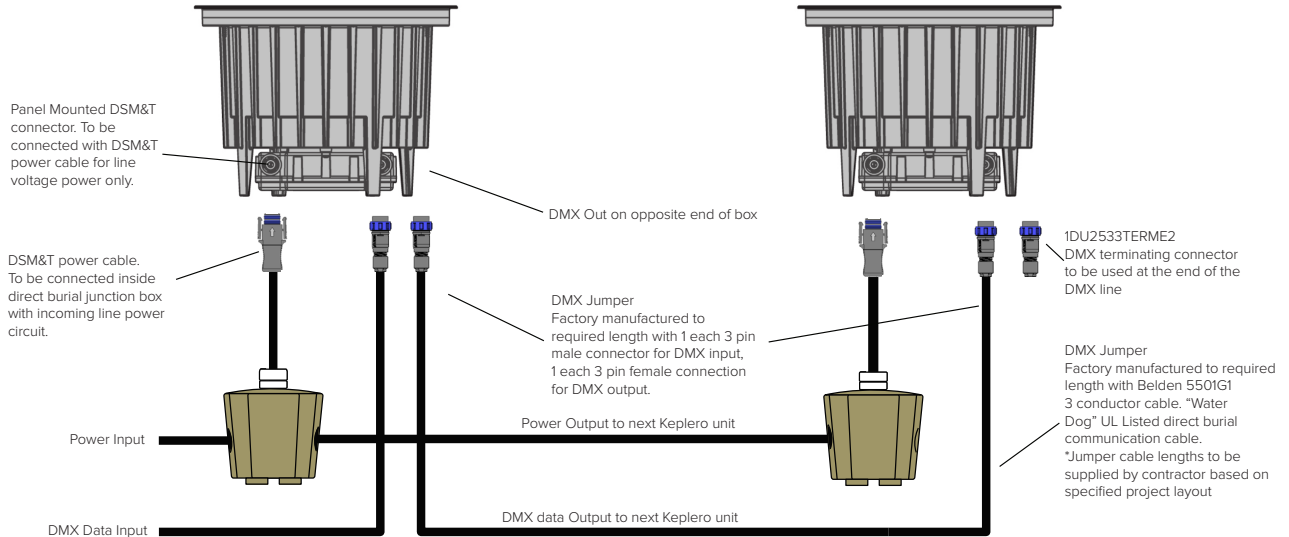

CONNECTION TERMINAL (REQUIRED)	
1DU2533TERME2	DMX IP68 End Terminal 2"L x 0.75" dia. male gold plated 3-pin connector terminal. Required for last fixture in run only.
LEAD CABLES (REQUIRED)	
1DU2533LEAD-20E2¹	20ft DMX data direct burial cable for fixture to controller lead wire connection with IP68 female 3-pin connector (DMX out) bare wire at opposite end for DMX in controller connection.
1DU2533LEAD-30E2¹	30ft DMX data direct burial cable for fixture to controller lead wire connection with IP68 female 3-pin connector (DMX out) bare wire at opposite end for DMX in controller connection.
1DU2533LEAD-40E2¹	40ft DMX data direct burial cable for fixture to controller lead wire connection with IP68 female 3-pin connector (DMX out) bare wire at opposite end for DMX in controller connection.
1DU2533LEAD-50E2¹	50ft DMX data direct burial cable for fixture to controller lead wire connection with IP68 female 3-pin connector (DMX out) bare wire at opposite end for DMX in controller connection.
¹ Consult factory for additional lengths.	

JUMPER CONNECTION CABLE (REQUIRED WITH USE OF MULTIPLE FIXTURES)	
1DU2533-10E2¹	10ft data direct burial cable for fixture to fixture connection with IP68 male 3-pin connector (DMX In) and IP68 female 3-pin connector (DMX out).
1DU2533-20E2¹	20ft data direct burial cable for fixture to fixture connection with IP68 male 3-pin connector (DMX In) and IP68 female 3-pin connector (DMX out).
1DU2533-30E2¹	30ft data direct burial cable for fixture to fixture connection with IP68 male 3-pin connector (DMX In) and IP68 female 3-pin connector (DMX out).
1DU2533-40E2¹	40ft data direct burial cable for fixture to fixture connection with IP68 male 3-pin connector (DMX In) and IP68 female 3-pin connector (DMX out).
1DU2533-50E2¹	50ft data direct burial cable for fixture to fixture connection with IP68 male 3-pin connector (DMX In) and IP68 female 3-pin connector (DMX out).
¹ Consult factory for additional lengths.	

TARGETTI

KEPLERO WALL WASHER RGBW

Controller:

Part No.	Type	Application	Voltage	Listing	Dimensions	Channels	Zones	Scenes
TGDMXSLESAU9	Stand-alone DMX 1/2 Universe Programmable Controller with Easy to Use Software Interface	Indoor Only	5.5V DC	ETL, UL	5.3"W x 5.5"H x 1.9D	256	1	20
TGDMXSLESAU11	Nicolaudie Slesa smart DMX interface, 2 DMX 512 universes, intuitive backlit keyboard programmable controller with easy to use software interface.	Indoor	5VDC 120V AC (Plug in power supply included)	ETL	6.3" x 3.6" x 1.8"	1024	5	99
TGDMXSTICKDE3B	Nicolaudie intelligent wall control keypad with glass touch sensitive graphic display, stand-alone DMX 512, 2 universe programmable controller with easy to use software interface. Black finish.	Indoor	6-7V DC 120V AC (Plug in power supply included)	ETL	5.8" x 4.2" x 0.5"	1024	10	500
TGDMXSTICKDE3W	Nicolaudie intelligent control keypad with glass touch sensitive graphic display, stand-alone DMX 512, 2 universe programmable controller with easy to use software interface. White finish.	Indoor	6-7V DC 120V AC (Plug in power supply included)	ETL	5.8" x 4.2" x 0.5"	1024	10	500



TGDMXSLESAU9



TGDMXSLESAU11



TGDMXSTICKDE3

CONTROL SYSTEM (OPTIONAL)

1E2767	USB-RDM Programmer code. DMX-RDM (Remote Device Management) address planner. Used with the "RDM Targetti" software that can be downloaded for free from the Targetti USA website . To be used with all RGBW products. The USB-RDM programmer manages to direct DMX-RDM fixtures if there are no BUFFER or Splitter DMXs on the section.
---------------	---



1E2767

INSTALLATION DIAGRAM - Concrete Pour Applications



Flush Mount Sleeve Assembly

1DU2394 Sleeve

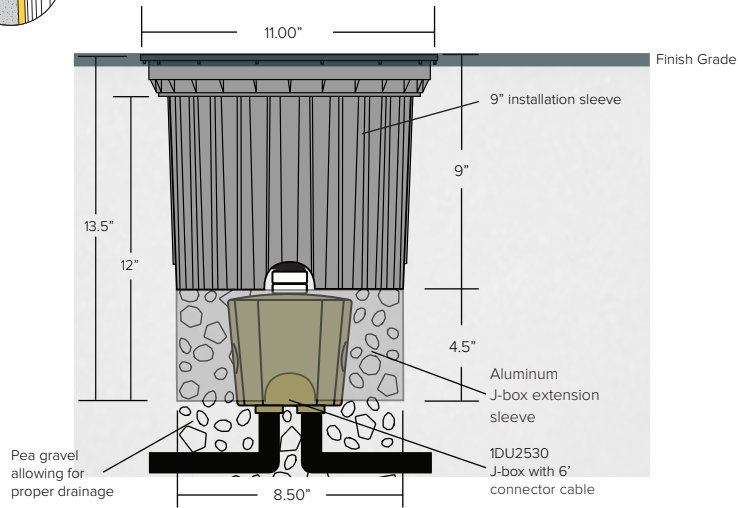

Semi-Flush Mount Sleeve Assembly

1DU2394 Sleeve

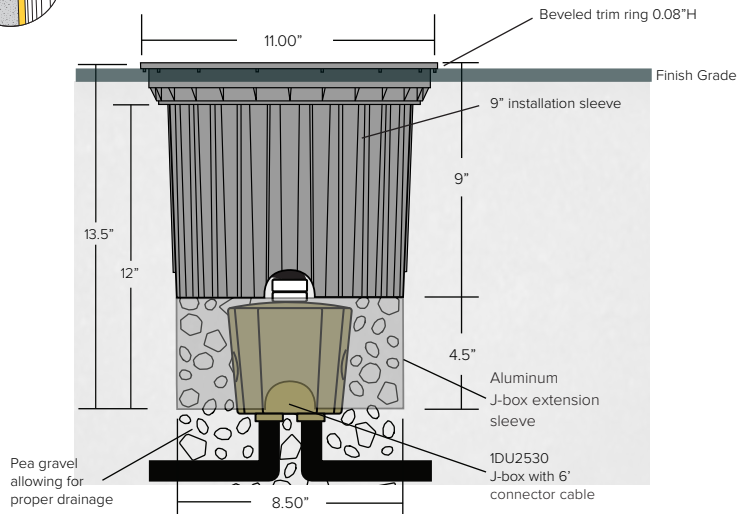

INSTALLATION DIAGRAM - Landscape Applications

RAISED TUBE INSTALLATION ASSEMBLY
Recommended for
LANDSCAPE INSTALLATION
(grasses and high level planting)
1DU4343 with Round Trim ONLY

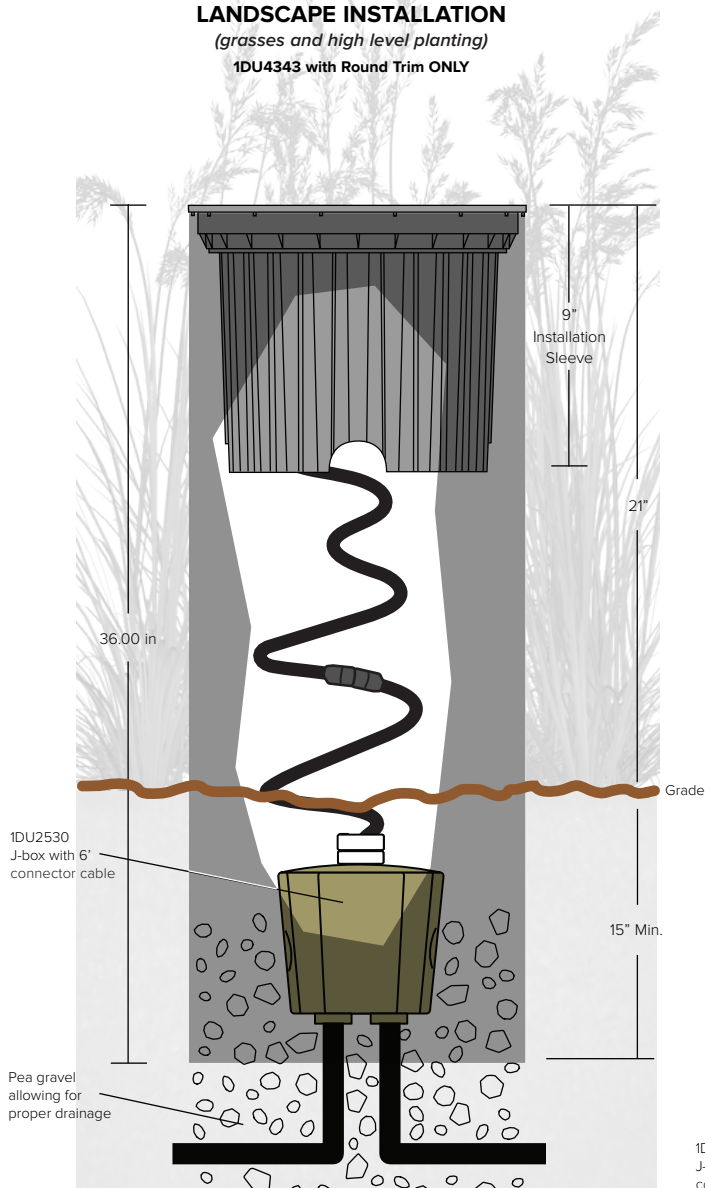

RAISED TUBE INSTALLATION ASSEMBLY
Recommended for
GROUND LEVEL INSTALLATION
(succulents and low level planting)
1DU434318 with Round Trim ONLY

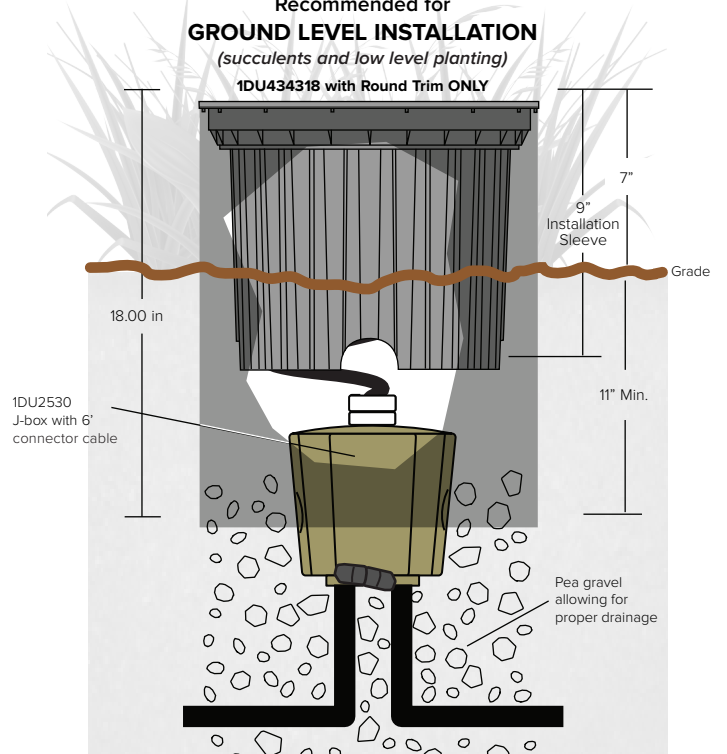

AT GRADE OR RAISED TUBE INSTALLATION ASSEMBLY
Recommended for
TURF OR GROUND COVER INSTALLATIONS
1DU434312 with Round Trim ONLY

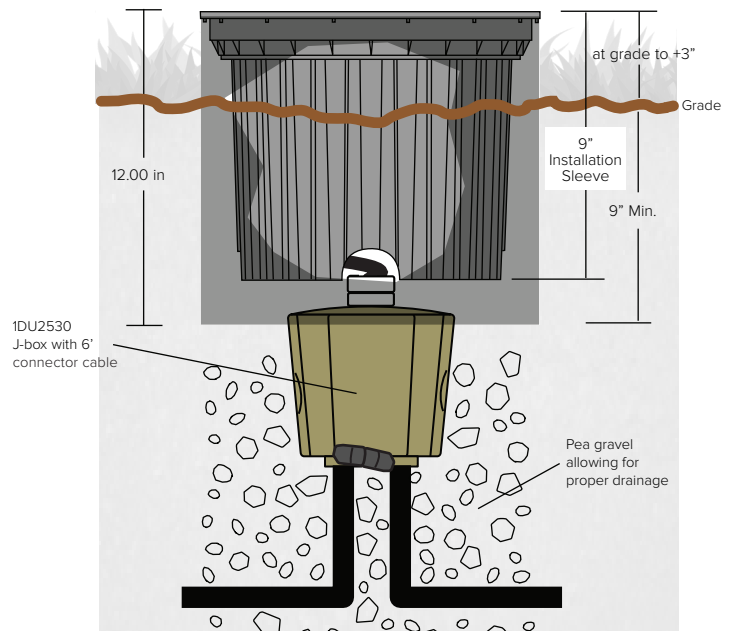

TARGETTI

KEPLERO WALL WASHER RGBW

INSTALLATION DIAGRAM - 1DU2530 J-Box

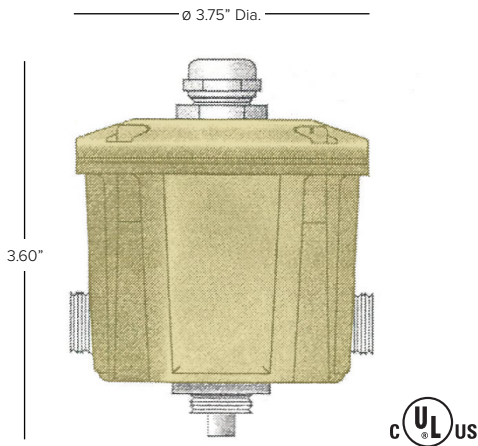

NOTE: Box fill size = 15.94 IN³

Certifications: cULus Wet Listed E496240

Brass junction box is supplied with the following components:

- (4) $\frac{3}{4}''$ side/bottom NPT holes
- (4) $\frac{1}{2}''$ reduction NPT adapters
- (2) $\frac{1}{2}''$ cap plugs

STEP 1:

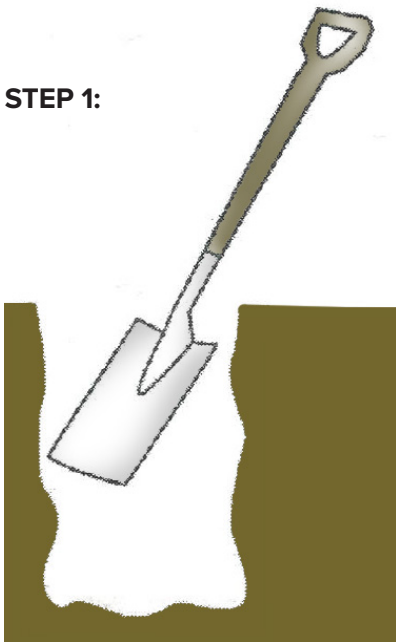

Dig a hole large enough to accommodate the junction box.

STEP 2:

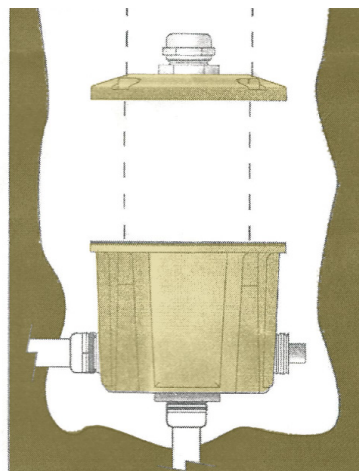

Connect brass junction box to conduit system. Seal conduit entries inside junction box with a good grade RTV sealant per sealant manufacturer's instructions.
Note: Drainage must be in place below junction box.

STEP 3:

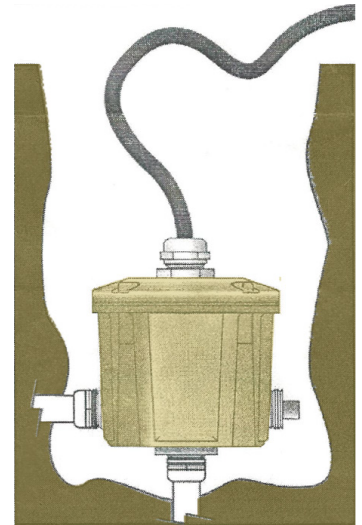

Seal threads. Tighten locking screw on bottom of cover. Connect all wires observing polarity (ie. green-to-ground, white-to-common, and black-to-voltage). Comes with $\frac{1}{2}''$ strain relief.

Optics

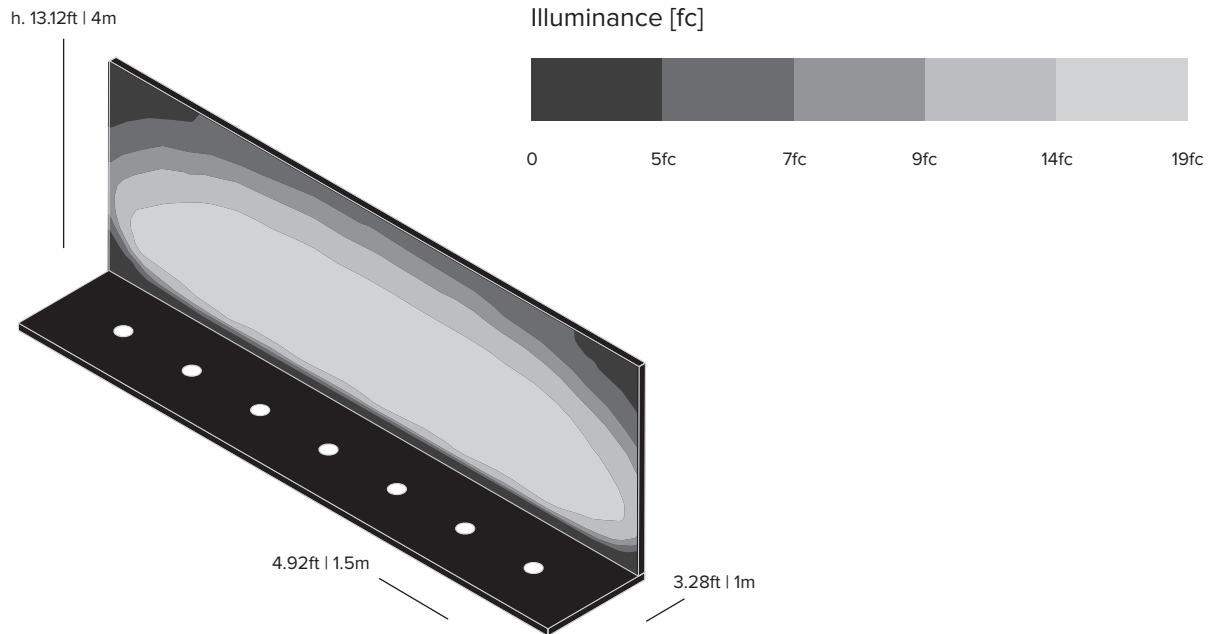

TARGETTI

KEPLERO WALL WASHER RGBW

Photometry Cont.

RED



		H(m)	D1(m)	D2(m)	E _{max} (lx)		
	-	-	114°	75°			
Fixture Power	20W	1	3.10	2.07	149		
Source Flux	359lm	2	6.19	4.14	37		
Fixture Flux	359lm	3	9.29	6.21	17		
Efficacy	18lm/W	4	12.39	8.29	9		
TS1026	I _{max} =550cd/klm	I _{max}	198cd	5	15.48	10.36	6

GREEN



		H(m)	D1(m)	D2(m)	E _{max} (lx)		
	-	-	114°	75°			
Fixture Power	28W	1	3.10	2.07	246		
Source Flux	594lm	2	6.19	4.14	61		
Fixture Flux	593lm	3	9.29	6.21	27		
Efficacy	21lm/W	4	12.39	8.29	15		
TS1026	I _{max} =550cd/klm	I _{max}	327cd	5	15.48	10.36	10

BLUE



		H(m)	D1(m)	D2(m)	E _{max} (lx)		
	-	-	114°	75°			
Fixture Power	20W	1	3.10	2.07	47		
Source Flux	113lm	2	6.19	4.14	12		
Fixture Flux	113lm	3	9.29	6.21	5		
Efficacy	6lm/W	4	12.39	8.29	3		
TS1026	I _{max} =550cd/klm	I _{max}	62cd	5	15.48	10.36	2

RGB



		H(m)	D1(m)	D2(m)	E _{max} (lx)		
	-	-	114°	75°			
Fixture Power	58W	1	3.10	2.07	393		
Source Flux	949lm	2	6.19	4.14	98		
Fixture Flux	949lm	3	9.29	6.21	44		
Efficacy	16lm/W	4	12.39	8.29	25		
TS1026	I _{max} =550cd/klm	I _{max}	522cd	5	15.48	10.36	16

RGBW

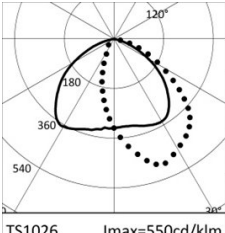

		H(m)	D1(m)	D2(m)	E _{max} (lx)		
	-	-	114°	75°			
Fixture Power	56W	1	3.10	2.07	452		
Source Flux	1091lm	2	6.19	4.14	113		
Fixture Flux	1091lm	3	9.29	6.21	50		
Efficacy	19lm/W	4	12.39	8.29	28		
TS1026	I _{max} =550cd/klm	I _{max}	600cd	5	15.48	10.36	18

4000°K



		4000K	H(m)	D1(m)	D2(m)	E _{max} (lx)	
	-	-	-	114°	75°		
Fixture Power	15W	1	3.10	2.07	148		
Source Flux	357lm	2	6.19	4.14	37		
Fixture Flux	357lm	3	9.29	6.21	16		
Efficacy	24lm/W	4	12.39	8.29	9		
TS1026	I _{max} =550cd/klm	I _{max}	196cd	5	15.48	10.36	6